

## The Best Choice for the Most Benefit!

We are committed to providing premium benefits to all of our customers.

# AC SERVO DRIVE

Xmotion

L7C Series

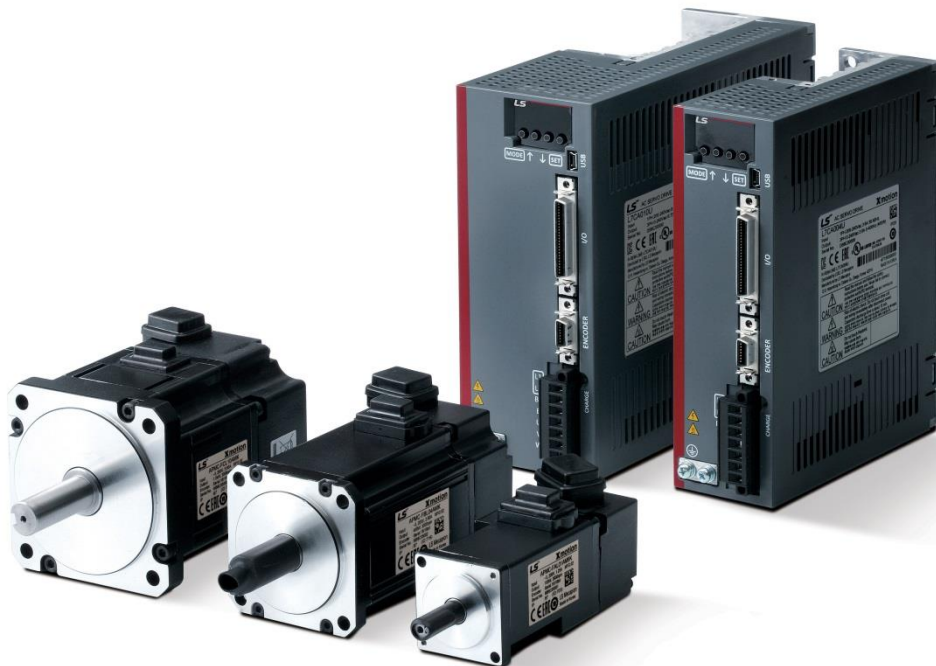

### Safety Precautions

- Read all safety precautions before using this product.
- After reading this manual, store it in a readily accessible location for future reference.

**LS** ELECTRIC



---

# Introduction



Greetings! Thank you for choosing L7C Series product.

The user manual describes how to correctly use this product and matters for which to exercise caution.

Failure to comply with the guidelines outlined in this manual may cause personal injury or damage to the product. Be sure to read this manual carefully before using this product and follow all guidelines contained therein.

- The contents of this manual are subject to change according to software versions without notice.
- Reproduction of part or all of the contents of this manual in any form, by any means or for any purpose is strictly prohibited without the explicit written consent of our company.
- Our company retains all patents, trademarks, copyrights and other intellectual property rights to the materials in this manual. Therefore, the information contained in this manual is only intended for use with our company products, and using it for any other purposes is prohibited.

Safety precautions are categorized as either **Warning** or **Caution**, depending on the severity of the consequences.

Precautions	Descriptions
 <b>Danger</b>	Failure to comply with the guidelines may cause serious injury or death.
 <b>Caution</b>	Failure to comply with the guidelines may cause personal injury or property damage.

- Depending on the situation, ignoring a caution may also result in serious injury. So, be mindful of this.

## ■ Electric Safety Precautions

### **Warning**

- Before wiring or inspection, turn off the power, wait 15 minutes, make sure that the charge lamp has gone off, and check the voltage.
- Ground both the servo drive and the servo motor faultlessly.
- Only qualified and trained technicians may perform wiring on this product.
- Install both the servo drive and the servo motor before performing any wiring.
- Do not operate the device with wet hands.
- Do not open the servo drive cover during operation.
- Do not operate the device with the servo drive cover removed.
- Even if the power is off, do not remove the servo drive cover.

## ■ Fire Safety Precautions

### **Caution**

- Install the servo drive, the servo motor, and the regenerative resistance on non-combustible materials.
- Disconnect the input power if the servo drive malfunctions.



## ■ Installation Precautions

Store and operate this product under the following environmental conditions.

Environment	Conditions	
	Servo Drive	Servo Motor
Operating temp.	0 ~ 50 °C	0 ~ 40 °C
Storage temp.	-20 ~ 65 °C	-10 ~ 60 °C
Operating humidity	90% RH or lower (no condensation)	20 ~ 80% RH (no condensation)
Storage humidity		
Altitude	1000m or lower	
Spacing	<ul style="list-style-type: none"> <li>▪ When installing 1 unit:               <ul style="list-style-type: none"> <li>• 40mm or more from the top or bottom of the control panel</li> <li>• 10mm or more from the left or right side of the control panel</li> </ul> </li> <li>▪ When installing 2 or more units:               <ul style="list-style-type: none"> <li>• 100mm or more from the top of the control panel</li> <li>• 40mm or more from the bottom of the control panel</li> <li>• 30mm or more from the left and right sides of the control panel</li> <li>• 2mm or more between units</li> <li>• Refer to Section 2.2.2, "Installation with the Control Panel."</li> </ul> </li> </ul>	
Others	<ul style="list-style-type: none"> <li>▪ Ensure the installation location is free from dust, iron, corrosive gas, and combustible gas.</li> <li>▪ Ensure the installation location is free from abnormal vibrations or potential for hard impacts.</li> </ul>	
<b>⚠ Caution</b>		
<ul style="list-style-type: none"> <li>▪ Make sure to install the product with the correct orientations.</li> <li>▪ Do not drop the product or expose it to a hard impact.</li> <li>▪ Install this product in a location that is free from water, corrosive gas, combustible gas, or flammable materials.</li> <li>▪ Install this product in a location capable of supporting the weight of this product.</li> <li>▪ Do not stand or place heavy objects on top of the product.</li> <li>▪ Always maintain the specified spacing when installing the servo drive.</li> <li>▪ Ensure that there are no conductive or flammable debris inside the servo drive or the servo motor.</li> <li>▪ Firmly attach the servo motor to the machine.</li> <li>▪ Make sure to install a gearbox-attached servo motor with the correct orientation.</li> <li>▪ Do not accidentally touch the rotating unit of the servo motor during operation.</li> <li>▪ Do not apply excessive force when connecting couplings to the servo motor shaft.</li> <li>▪ Do not place loads on the servo motor shaft that exceed the permitted amount.</li> </ul>		

## ■ Wiring Precautions

### ⚠ Caution

- Make sure to use AC power for input power of the servo drive.
- Use a voltage source that is suitable for 200[V] (AC 200~230[V]).
- Always connect the servo drive to a ground terminal.
- Do not connect a commercial power supply directly to the servo motor.
- Do not connect commercial power supply directly to U, V and W output terminals of the servo drive.
- Connect U, V and W output terminals of the servo drive directly to the U, V, W power input terminals of the servo motor, but do not install magnetic contactors between the wires.
- Always use pressurized terminals with insulation tubes when wiring the servo drive power terminal.
- When wiring, be sure to separate U, V and W power cables for the servo motor and the encoder cable.
- Always use the robot cable if the motor is of a moving structure.
- Before performing power wiring, turn off the input power of the servo drive and wait until the charge lamp goes off completely.

## ■ Startup Precautions

### ⚠ Caution

- Check the input voltage and power unit wiring before supplying power to the device.
- The servo must be in OFF mode when you turn on the power.
- For L7C□ □□□, check the motor's ID, encoder type, and encoder pulse before turning on the power.
- For L7C□ □□□, first set the motor's ID for [0x2000], encoder type for [0x2001], and encoder pulse for [0x2002] after turning on the power.
- After completing the above settings, set the drive mode for the servo drive connected to the upper level controller in [0x3000].
- Perform I/O wiring for the servo drive referring to Section 2.5, "Wiring for Input/Output Signals."

## ■ Handling and Operating Precautions

### ⚠ Caution

- Check and adjust each parameter before operation.
- Do not touch the rotating unit of the motor during operation.
- Do not touch the heat sink during operation.
- Be sure to attach or remove I/O, ENC connectors only when the power is off.
- Extreme changes of parameters may cause system instability.

## ■ Usage Precautions

### ⚠ Caution

- Install an emergency cut-off circuit which can immediately stop operation in an emergency.
- Reset the alarm only when the servo is off. Be warned that the system restarts immediately if the alarm is reset while the servo is on.
- Use a noise filter or DC reactor to minimize electromagnetic interference. This prevents nearby electrical devices from malfunctioning due to interference.
- Only use approved servo drive and servo motor combinations.
- The electric brake on the servo motor is for maintaining paused operation. Do not use it for ordinary braking.
- The electric brake may malfunction if the brake degrades or if the mechanical structure is improper (for example, if the ball screw and servo motor are combined via the timing belt). Install an emergency stop device to ensure mechanical safety.

## ■ Malfunction Precautions

### ⚠ Caution

- Use a servo motor with an electric brake or install a separate brake system for use if there is potential for a dangerous situation during emergencies or device malfunctions.
- If an alarm occurs, eliminate the underlying cause of the problem and ensure safety in operation. Then, deactivate the alarm and resume operation.
- Do not approach the machine until the problem is solved.

## ■ Repair/Inspection Precautions

### ⚠ Caution

- Before performing repair or inspection, turn off the power, wait at least 15 minutes, make sure that the charge lamp has gone off, and check the voltage. Enough voltage may remain in the electrolytic condenser after the power is off to cause an electric shock.
- Only authorized personnel may repair and inspect the device or replace its parts.
- Never modify this device in any way.

## ■ General Precautions

### ⚠ Caution

- This user manual is subject to change due to product modification or changes in standards. If such changes occur, we issue a new user manual with a new product number.

## ■ Product Application

### **Caution**

- This product is not designed or manufactured for machines or systems intended to sustain human life.
- This product is manufactured under strict quality control conditions. Nevertheless, install safety devices if installing the product in a facility where product malfunctions may result in a major accident or a significant loss.

## ■ EEPROM Lifespan

### **Caution**

- EEPROM is rewritable up to 4 million times for the purpose of recording parameter settings and other information. The servo drive may malfunction if the total number of the following tasks exceeds 4 million, due to the lifespan of the EEPROM.
  - EEPROM recording as a result of a parameter change
  - EEPROM recording as a result of an alarm

# Table of Contents

<b>1. Product Configuration .....</b>	<b>1-1</b>
1.1 Product Verification .....	1-1
1.2 Product Specifications .....	1-2
1.3 Component Names .....	1-4
1.3.1 Servo Drive Component Names .....	1-4
1.3.2 Servo Motor Part Names .....	1-6
1.4 Example of System Configuration .....	1-7
<b>2. Product features .....</b>	<b>2-1</b>
2.1 Servo Motor.....	2-1
2.1.1 Product Feature.....	2-1
2.1.2 External View .....	2-6
2.2 Servo Drive.....	2-9
2.2.1 Product Features .....	2-9
2.2.2 External View .....	2-11
2.3 Options and Peripheral Devices .....	2-12
<b>3. Wiring and Connection.....</b>	<b>3-1</b>
3.1 Servo Motor Installation.....	3-1
3.1.1 Operating Environment.....	3-1
3.1.2 Preventing Over-impact.....	3-1
3.1.3 Motor Connection .....	3-2
3.1.4 Load Device Connection .....	3-3
3.1.5 Cable Installation.....	3-3
3.2 Servo Drive Installation .....	3-4
3.2.1 Installation and Usage Environment .....	3-4
3.2.2 Installation with the Control Panel .....	3-5
3.3 Internal Block Diagram of the Servo Drive .....	3-9
3.3.1 Drive Block Diagram (100W ~ 1.0kW).....	3-9
3.4 Power Supply Wiring .....	3-10
3.4.1 Power Supply Wiring Diagram (100W ~ 1.0kW).....	3-11
3.4.2 Power Input Sequence .....	3-12
3.4.3 Power Circuit Electrical Component Standards .....	3-13
3.5 Wiring for Input/Output Signals.....	3-14
3.5.1 Names and Functions of Digital Input/Output Signals.....	3-15
3.5.2 Names and Functions of Analog Input/Output Signals.....	3-20

3.5.3	Names and Functions of Pulse Train Input Signals .....	3-21
3.5.4	Names and Functions of Encoder Output Signals .....	3-21
3.5.5	Examples of Input/Output Signal Connection .....	3-22
3.5.6	Pulse Train Input Signal.....	3-25
3.5.7	Input/Output Signals Configuration Diagram .....	3-26
3.6	Encoder Signal Panel (Encoder Connector) Wiring .....	3-27
3.6.1	Encoder Signal Names by Type .....	3-27
3.6.1	Precautions when Making Encoder Cable .....	3-29
3.7	Power Connector .....	3-30
<b>4.</b>	<b>Operation Modes .....</b>	<b>4-1</b>
4.1	Control Method .....	4-1
4.2	Indexing Position Operation.....	4-1
4.2.1	Coordinate Settings .....	4-5
4.2.2	Index Structure .....	4-7
4.3	Pulse Input Position Operation .....	4-8
4.4	Velocity Mode .....	4-12
4.5	Torque Operation.....	4-16
<b>5.</b>	<b>Indexing Position Operation .....</b>	<b>5-1</b>
5.1	Concept of Index .....	5-1
5.2	Index Type .....	5-8
5.2.1	Absolute/Relative Move.....	5-8
5.2.2	Registration Absolute/Relative Move .....	5-9
5.2.3	Blending Absolute/Relative Move .....	5-10
5.2.4	Rotary Absolute/Relative Move .....	5-11
5.2.5	Rotary Shortest Move.....	5-12
5.2.6	Rotary Positive/Negative Move .....	5-13
5.3	Function of Index Input Signal .....	5-15
5.4	Function of Index Output Signal .....	5-19
5.5	Analog Velocity Override .....	5-22
5.6	Example of Indexing Operation Configuration Diagram.....	5-24
<b>6.</b>	<b>Pulse Input Position Operation .....</b>	<b>6-1</b>
6.1	Pulse Input Logic Function Setting .....	6-2
6.2	Pulse Input Logic Function Setting .....	6-3
6.3	Function Setting of PCLEAR .....	6-4
6.4	Function Setting of INHIBIT .....	6-4
6.5	Example of Pulse Drive Mode Configuration Diagram.....	6-5

6.5.1	Example of Connection with PLC Devices.....	6-6
<b>7.</b>	<b>Velocity Mode.....</b>	<b>7-1</b>
7.1	Velocity Command Switch Select Function Setting .....	7-1
7.2	Analog Velocity Command .....	7-2
7.3	Multi-Velocity Command.....	7-4
7.4	Example of Velocity Mode Configuration Diagram .....	7-5
<b>8.</b>	<b>Torque Operation.....</b>	<b>8-1</b>
8.1	Analog Torque Command Scale.....	8-1
8.2	Velocity Setting for Torque Operation .....	8-2
8.3	Example of Torque Mode Configuration Diagram.....	8-3
<b>9.</b>	<b>Operation Mode Switching.....</b>	<b>9-1</b>
<b>10.</b>	<b>Homing .....</b>	<b>10-1</b>
10.1	Homing Method.....	10-2
<b>11.</b>	<b>Drive Application Functions .....</b>	<b>11-1</b>
11.1	Drive Front Panel .....	11-1
11.1.1	7-Segment for Indicating the Servo Status .....	11-2
11.1.2	Loader Control Method.....	11-4
11.1.3	Control.....	11-8
11.2	Input/Output Signals Setting.....	11-33
11.2.1	Assignment of Digital Input Signals .....	11-33
11.2.2	Digital Output Signal Assignment .....	11-37
11.3	Electric Gear Setup .....	11-40
11.3.1	Indexing Position Operation Electric Gear .....	11-40
11.3.2	Example of Indexing Position Operation Electric Gear Setting .....	11-55
11.3.3	Calculation of Velocity and Acceleration/Deceleration for Use of Electric Gear.....	11-56
11.3.4	Electric Gear for Pulse Input Position Operation.....	11-58
11.4	Velocity Control Settings .....	11-59
11.4.1	Smooth Acceleration and Deceleration.....	11-59
11.4.2	Smooth Acceleration and Deceleration Through Step Analog Voltage Input.....	11-60
11.4.3	Servo-lock Function.....	11-62
11.4.4	Velocity Control Signals.....	11-62
11.5	Position Control Settings .....	11-63
11.5.1	Position Command Filter .....	11-63
11.5.2	Position Control Signals .....	11-65
11.6	Positive/Negative Limit Setting.....	11-66
11.7	Brake Output Signal Function Setting .....	11-67

11.8	Torque Limit Function .....	11-69
11.9	Gain Conversion Function .....	11-72
11.9.1	Gain Group Conversion.....	11-72
11.9.2	P/PI control switch.....	11-74
11.10	Dynamic Brake .....	11-76
11.11	Regenerative Brake Resister Setting.....	11-78
11.11.1	Use of External regenerative resistance.....	11-79
11.11.2	Regenerative Overload.....	11-80
11.11.3	Other Considerations .....	11-81
11.12	Encoder Signal Output .....	11-82
11.13	Absolute Encoder Data Transmission (ABS_RQ).....	11-83
<b>12.</b>	<b>Tuning.....</b>	<b>12-1</b>
12.1	Automatic Gain Adjustment (Off-Line Auto Tuning) .....	12-1
12.2	Automatic Gain Adjustment (On-line Auto Tuning).....	12-2
12.3	Manual Gain Tuning .....	12-6
12.3.1	Gain Tuning Sequence.....	12-6
12.4	Vibration Control.....	12-9
12.4.1	Notch Filter.....	12-9
12.4.2	Adaptive Filter .....	12-10
12.4.3	Vibration Suppression Filter .....	12-11
<b>13.</b>	<b>Procedure Function.....</b>	<b>13-1</b>
13.1	Manual Jog Operation .....	13-1
13.2	Program Jog Operation .....	13-2
13.3	Deleting Alarm History .....	13-3
13.4	Automatic Gain Tuning .....	13-4
13.5	Index Pulse Search .....	13-4
13.6	Absolute Encoder Reset.....	13-5
13.7	Instantaneous Maximum Torque Reset .....	13-6
13.8	Phase Current Offset Tuning .....	13-6
13.9	Software Reset.....	13-7
13.10	Commutation .....	13-7
<b>14.</b>	<b>Object Dictionary .....</b>	<b>14-1</b>
14.1	Data Type .....	14-2
14.2	Basic Setting (0x2000~) .....	14-3



14.3	Gain Adjustment (0x2100~)	14-21
14.4	I/O Configuration (0x2200~)	14-32
14.5	Velocity Control (0x2300~)	14-41
14.6	Miscellaneous Setting (0x2400~)	14-48
14.7	Enhanced Control (0x2500~)	14-57
14.8	Monitoring (0x2600~)	14-63
14.9	Procedure and Alarm history (0x2700~)	14-72
14.10	Third Party Motor Support (0x2800~)	14-76
14.11	Index Objects(0x3000~)	14-80
<b>15.</b>	<b>Maintenance and Inspection</b>	<b>15-1</b>
15.1	Diagnosing Abnormalities and Troubleshooting	15-1
15.2	Precautions	15-1
15.3	Inspection Points	15-1
15.4	Parts Replacement Cycle	15-3
15.5	Servo Alarms	15-4
15.6	Servo Warnings	15-10
15.7	How to Replace Encoder Battery	15-13
15.8	Servo Overload Graph	15-14
15.9	Servo Motor Formats and IDs (continued on the next page)	15-18
<b>16.</b>	<b>Communication Protocol</b>	<b>16-1</b>
16.1	Overview and Communication Specifications	16-1
16.1.1	Overview	16-1
16.1.2	Communication Specifications and Cable Access Rate	16-2
16.2	Basic Structure of Communication Protocol	16-3
16.2.1	Sending/Receiving Packet Structure	16-3
16.2.2	Protocol Command Codes	16-6
16.3	Parameter Saving & Reset	16-38
16.4	L7C Servo Drive Communication Address Table	16-40
16.4.1	Basic Setting Parameters	16-40
16.4.2	Gain Adjustment Parameters	16-42
16.4.3	I/O Configuration Parameters	16-43
16.4.4	Velocity Control Parameters	16-44
16.4.5	Miscellaneous Setting Parameters	16-45
16.4.6	Enhanced Control Parameters	16-46
16.4.7	Monitoring Parameters	16-47
16.4.8	Procedures and Alarm History	16-48

16.4.9 3rd Party Motor Parameters ..... 16-49  
16.4.10 Index Related Parameters ..... 16-49

**17. Test Drive ..... 17-1**

17.1 Preparation for Operation ..... 17-2  
17.1.1 Indexing Position Operation ..... 17-3  
17.1.2 Pulse Input Position Operation ..... 17-6  
17.1.3 Velocity Mode ..... 17-9  
17.1.4 Torque Operation ..... 17-12

**18. Appendix ..... 18-1**

18.1 Firmware Update ..... 18-1  
18.1.1 Using Drive CM ..... 18-1  
18.2 Summary of Parameters ..... 18-6





# 1. Product Configuration

## 1.1 Product Verification

1. Check the name plate to verify that the product received matches the model ordered.
  - Does the servo drive's name plate match?
  - Does the servo motor's name plate match?
2. Check the product components and options.
  - Are the types and lengths of cables correct?
  - Does the regenerative resistance conform to the required standard?
    - ♦ Is the shape of the shaft correct?
    - ♦ Are there any abnormalities after mounting the oil seal or the brake?
    - ♦ Are the gearbox and the gear ratios correct?
    - ♦ Is the encoder format correct?
3. Check the exterior of the product.
  - Are there any foreign substances or humidity in the product?
  - Is there any discoloration, contaminant, damage or disconnected wire?
  - Are the bolts tightly fastened to the joints?
  - Is there any abnormal sound or excessive friction during rotation?

## 1.2 Product Specifications

### ■ L7C Series Product Type

L7 C A 004 U O

Series Name	Series Name	Input Voltage	Capacity (200[V])	Encoder	Option
L7 series	C: Standard I/O	A : 200[Vac]	001 : 100[W]	U : Universal	Blank : Standard
			002 : 200[W]		Marked : Exclusive
			004: 400[W]		
			008: 800[W]		
			010: 1[kW]		

## ■ Servo Motor Product Type

# APM C – F B L 01 A Y K 1

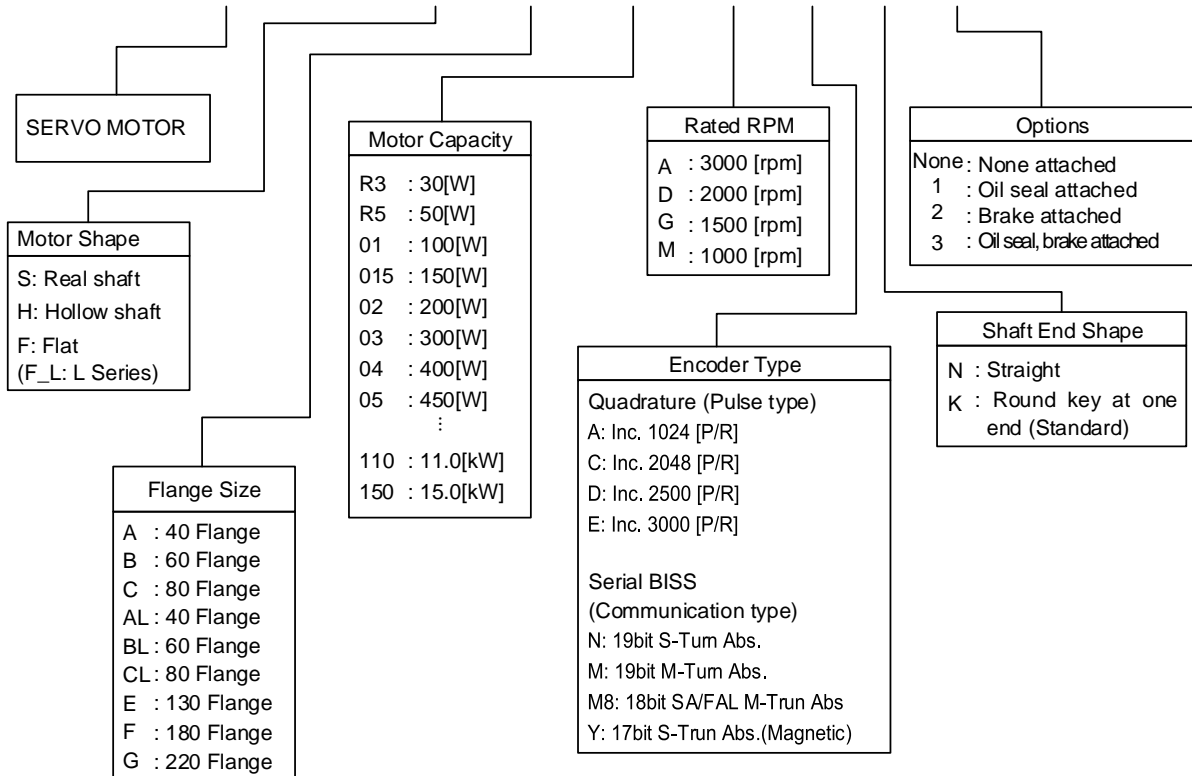

## 1.3 Component Names

### 1.3.1 Servo Drive Component Names

■ 100W, 200W, 400W

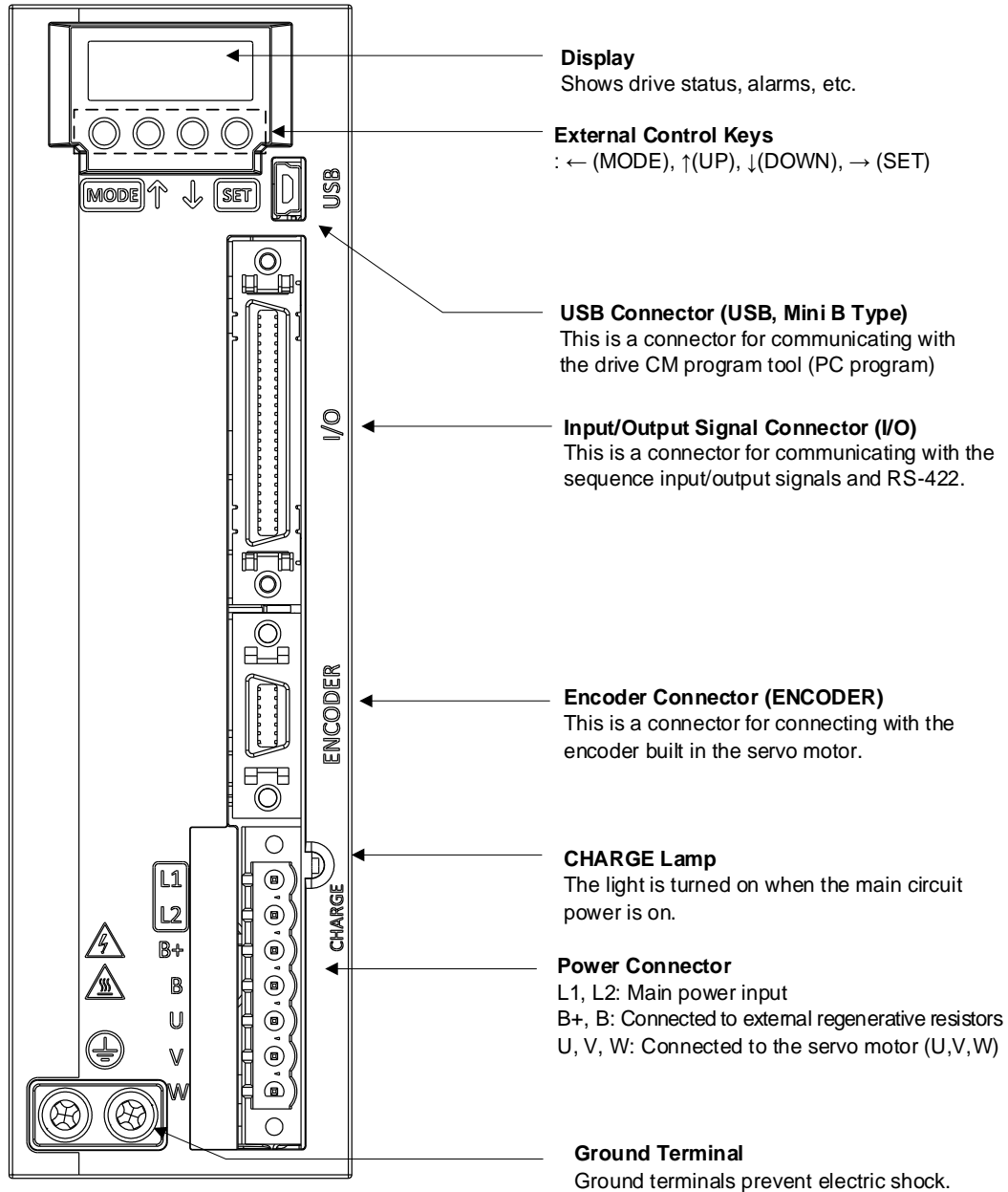



## ■ 800W, 1kW

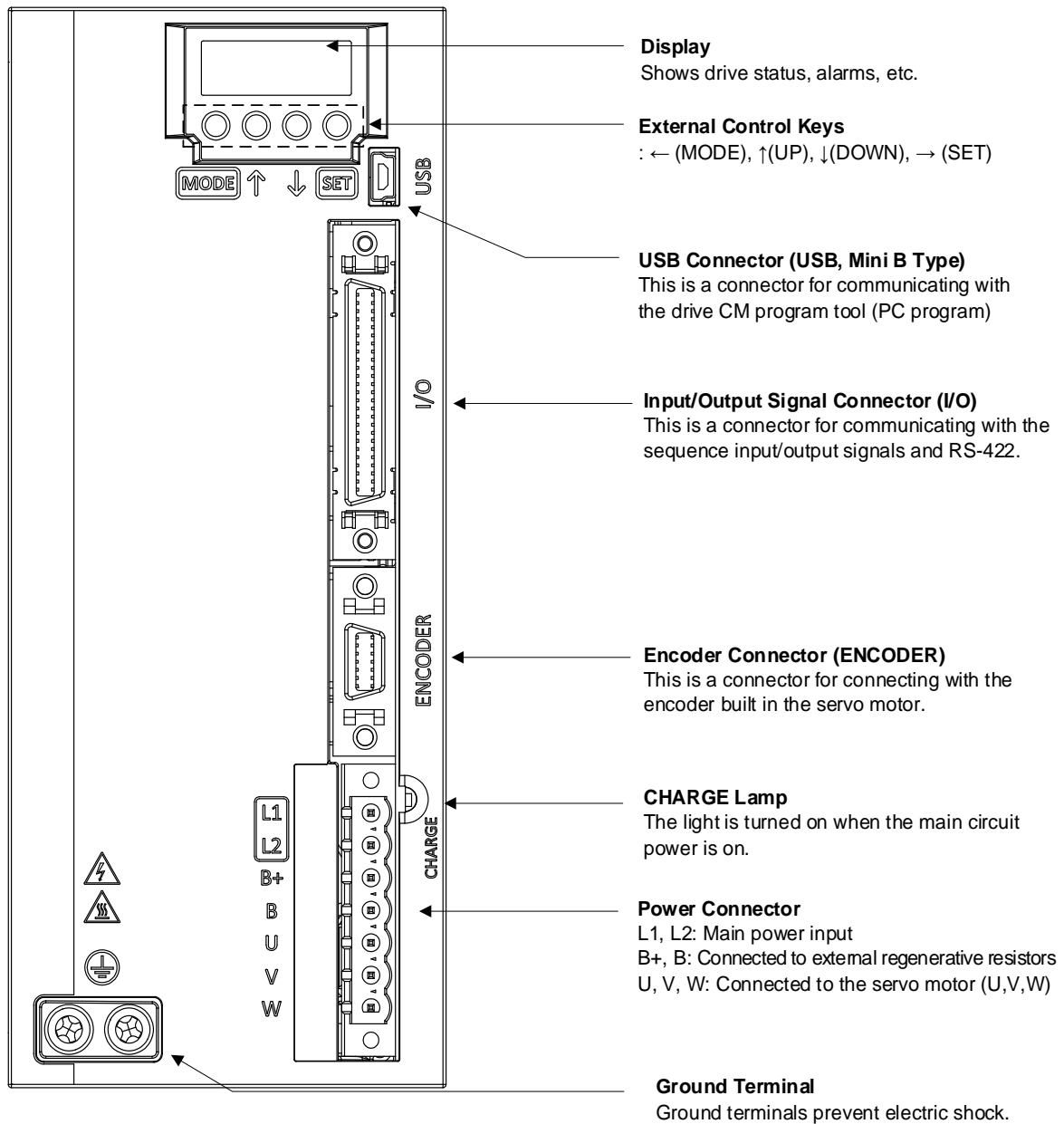

## 1.3.2 Servo Motor Part Names

### ■ 80 Flange or Lower

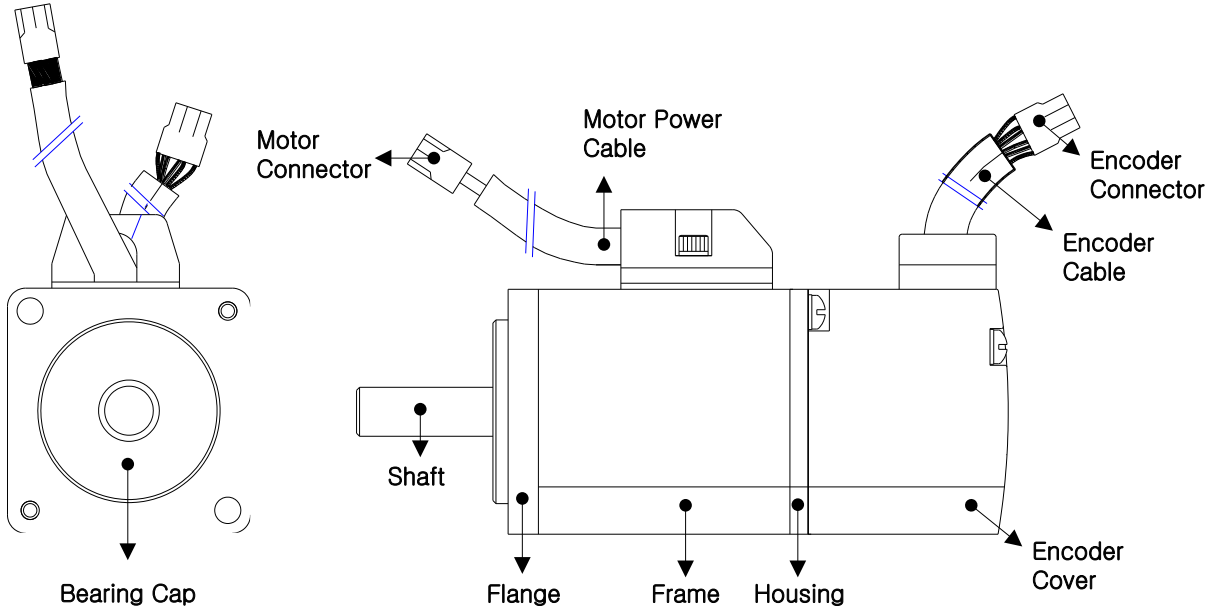

### ■ 130 Flange or Higher

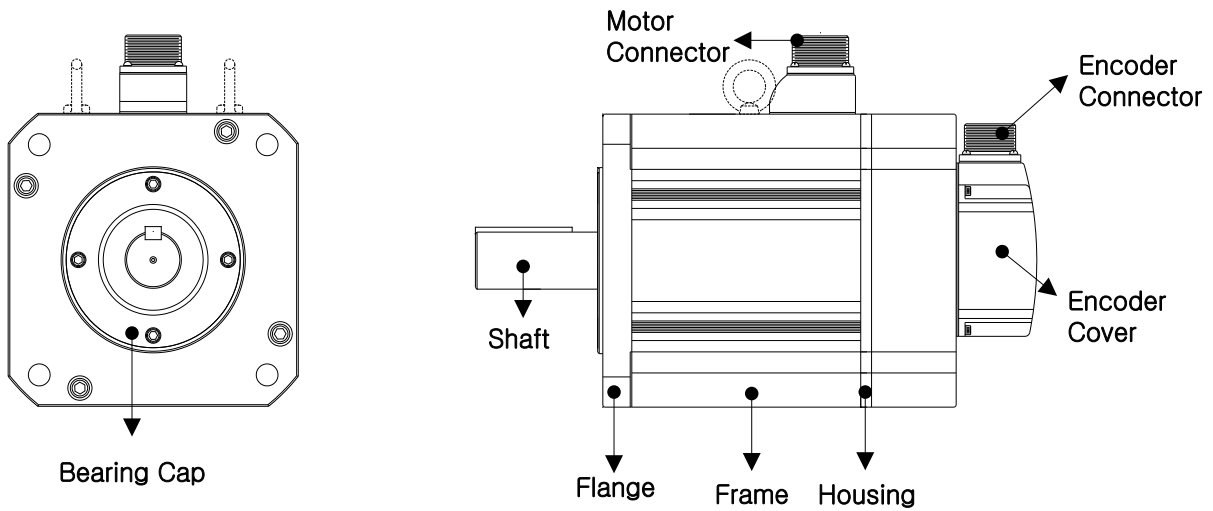

## 1.4 Example of System Configuration

The figure below shows an example of system configuration using this drive.

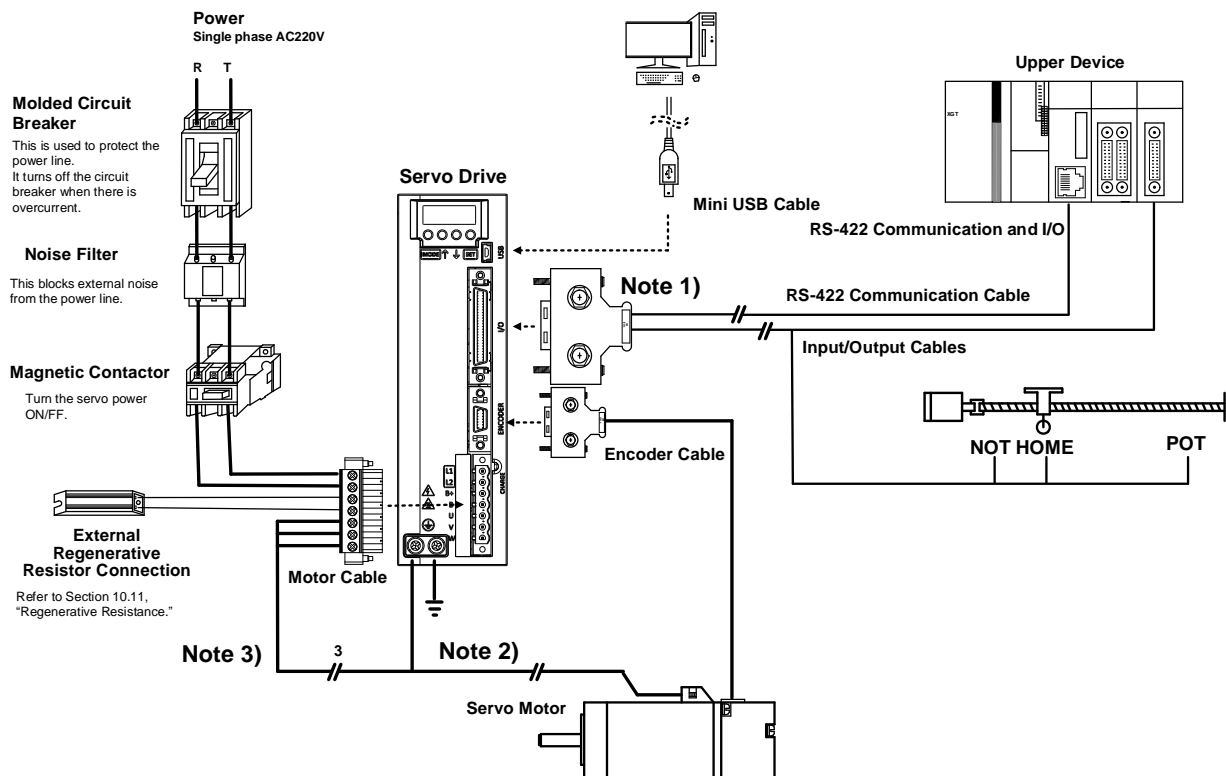

### ⚠ Caution

- Note 1) Do not use APC-VSCN1T or APC-VPCN1T during communication wiring. Communication may be disconnected due to disconnection in cable shields. Also, build the structure of a single connector holding individual lines of RS-422 communication cables and input/output cables. Make sure to use shielded twisted cables (Twisted Pair Wire) for RS-422 communication cable.
- Note 2) PE between the servo motor and the servo and between the servo and the device must be connected.
- Note 3) This device supports encoder cables and motor cables that are 20m or shorter.
- If it is necessary to make a cable longer than 20m, refer to "2.6.2 Precautions When Making Encoder Cable."



## 2. Product features

### 2.1 Servo Motor

#### 2.1.1 Product Feature

##### ■ Heat Sink Specificationa

Utem	Dimenstions(mm)	Item
AP04	250x250x6	Aluminum
AP06	250x250x6	
AP08	250x250x12	

- ※ The product specifications are based on the measurement data obtained after mounting the heat sink.
- ※ IP grade products do not include the shaft penetration part.
- ※ IP grade is not guaranteed for any gearbox attached.
- ※ When a cable is bent by more than the specified bending rate, it may not qualify for the specified IP grade.
- ※ Use only the dedicated heat sink cables to satisfy the specified IP grade conditions.

## 2. Product features

### ■ Product Features [200V]

Servo Motor Type (APM-□□□□□)		FALR5A	FAL01A	FAL015A	FBL01A	FBL02A	FBL04A
Applicable Drive (L7□A□□)		L7□A001		L7□A002	L7□A001	L7□A002	L7□A004
Rated output	[kW]	0.05	0.10	0.15	0.10	0.20	0.40
	[N·m]	0.16	0.32	0.48	0.32	0.64	1.27
Rated torque	[kgf·cm]	1.62	3.25	4.87	3.25	6.49	12.99
	[N·m]	0.48	0.96	1.43	0.96	1.91	3.82
Maximum instantaneous torque	[kgf·cm]	4.87	9.74	14.62	9.74	19.48	38.96
	[A] <sub>Φ.ac.ms</sub>	0.95	1.25	1.52	0.95	1.45	2.60
Peak current	[A] <sub>Φ.ac.ms</sub>	2.85	3.75	4.56	2.85	4.35	7.80
Rated rotation velocity	[r/min]	3000					
Maximum rotation velocity	[r/min]	5000					
Moment of inertia	[kg·m <sup>2</sup> ×10 <sup>-4</sup> ]	0.023	0.042	0.063	0.091	0.147	0.248
	[gf·cm·s <sup>2</sup> ]	0.024	0.043	0.065	0.093	0.150	0.253
Permitted load inertia		Motor inertia x 30			Motor inertia x 20		
Rated power rate	[kW/s]	10.55	23.78	36.19	11.09	27.60	27.07
Velocity, position detector	Standard	Serial Single-Turn Built – in Type (17bit)					
	Option	x					
Specifications and features	Protection method	Fully enclosed self-cooling IP67 (excluding shaft penetration part)					
	Time rating	Continuous					
	Ambient temperature	Use temperature: 0~40 [°C], maintenance temperature: -10~60 [°C]					
	Ambient humidity	Use humidity: 80[%] RH, maintenance humidity: 90[%] RH or lower (no condensation)					
	Atmosphere	No direct sunlight or corrosive or combustible gas					
	Anti-vibration	Vibration acceleration 49 [m/s <sup>2</sup> ] (5G)					
Weight	[kg]	0.31	0.45	0.61	0.54	0.72	1.04

### ◆ Rotation velocity - Torque characteristics [■: 3-phase AC200V, ▨: 3-phase AC230V]

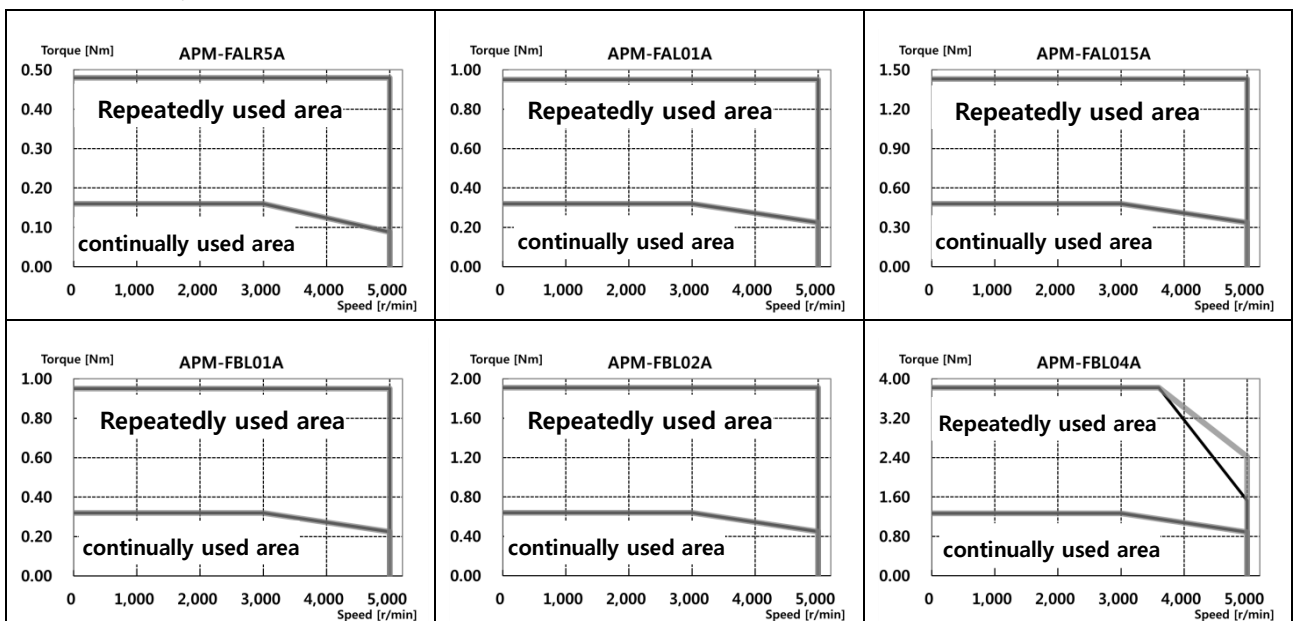

■ Product Features [200V]

Servo Motor Type (APM-□□□□□)		FCL04A	FCL06A	FCL08A	FCL10A			
Applicable Drive (L7□A□□)		L7□A004	L7□A008		L7□A010			
Rated output	[kW]	0.40	0.60	0.75	1.00			
Rated torque	[N·m]	1.27	1.91	2.39	3.18			
	[kgf·cm]	12.99	19.49	24.36	32.48			
Maximum instantaneous torque	[N·m]	3.82	5.73	7.16	9.55			
	[kgf·cm]	38.98	58.47	73.08	97.44			
Rated current	[A] <sub>φ.ac.rms</sub>	2.58	3.81	5.02	5.83			
Peak current	[A] <sub>φ.ac.rms</sub>	7.75	11.42	15.07	17.50			
Rated rotation velocity	[r/min]	3000						
Maximum rotation velocity	[r/min]	5000						
Moment of inertia	[kg·m <sup>2</sup> ×10 <sup>-4</sup> ]	0.530	0.897	1.264	1.632			
	[gf·cm·s <sup>2</sup> ]	0.541	0.915	1.290	1.665			
Permitted load inertia		Motor inertia x 15						
Rated power rate	[kW/s]	30.60	40.66	45.09	62.08			
Velocity, position detector	Standard	Serial Single-Turn Built – in Type (17bit)						
	Option	x						
Specifications and features	Protection method	Fully enclosed self-cooling IP67 (excluding shaft penetration part)						
	Time rating	Continuous						
	Ambient temperature	Use temperature: 0~40 [°C], maintenance temperature: -10~60 [°C]						
	Ambient humidity	Use humidity: 80[%] RH, maintenance humidity: 90[%] RH or lower (no condensation)						
	Atmosphere	No direct sunlight or corrosive or combustible gas						
	Anti-vibration	Vibration acceleration 49 [m/s <sup>2</sup> ] (5G)						
Weight	[kg]	1.49	2.11	2.65	3.27			

◆ Rotation velocity - Torque characteristics [■: 3-phase AC200V, ▨: 3-phase AC230V]

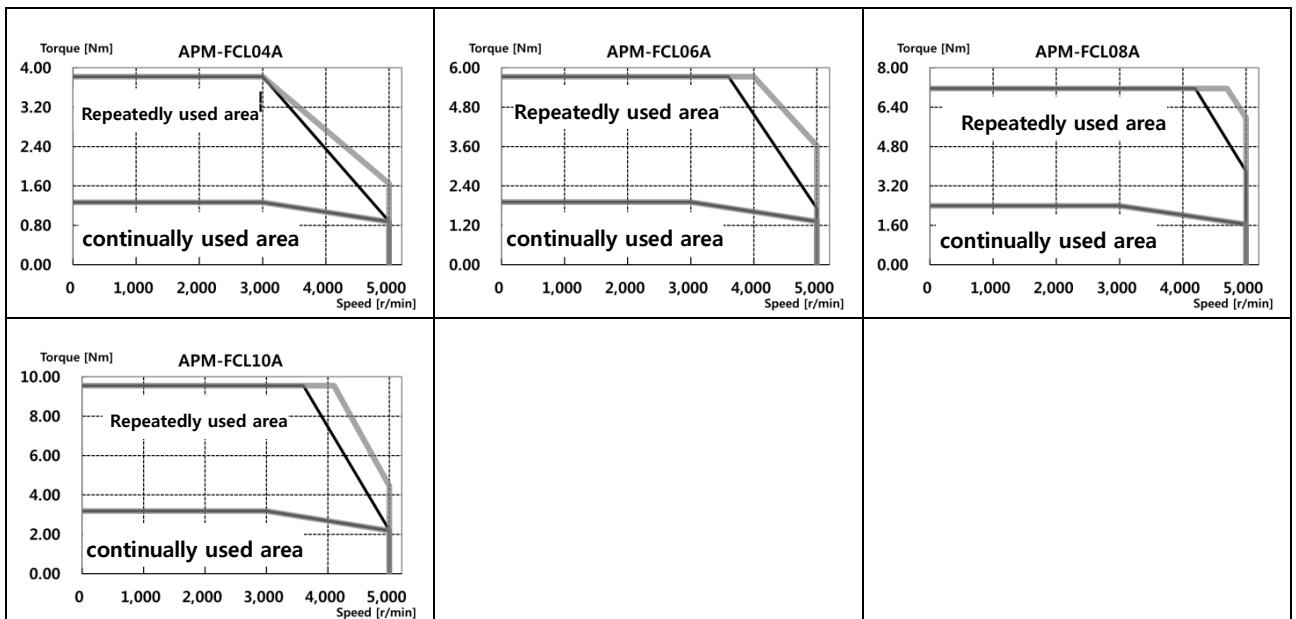

## 2. Product features

### ■ Product Features [200V]

Servo Motor Type (APM-□□□□□)		FCL03D	FCL05D	FCL06D	FCL07D			
Applicable Drive (L7□A□□)		L7□A004	L7□A008					
Rated output	[kW]	0.30	0.45	0.55	0.65			
Rated torque	[N·m]	1.43	2.15	2.63	3.10			
	[kgf·cm]	14.62	21.92	26.80	31.67			
Maximum instantaneous torque	[N·m]	4.30	6.45	7.88	9.31			
	[kgf·cm]	43.85	65.77	80.39	95.01			
Rated current	[A] <sub>φ.ac.ms</sub>	2.50	3.05	3.06	3.83			
Peak current	[A] <sub>φ.ac.ms</sub>	7.51	9.16	9.18	11.50			
Rated rotation velocity	[r/min]	2000						
Maximum rotation velocity	[r/min]	3000						
Moment of inertia	[kg·m <sup>2</sup> ×10 <sup>-4</sup> ]	0.530	0.897	1.264	1.63			
	[gf·cm <sup>2</sup> ]	0.541	0.915	1.290	1.66			
Permitted load inertia		Motor inertia x 15						
Rated power rate	[kW/s]	38.73	51.47	54.56	59.03			
Velocity, position detector	Standard	Serial Single-Turn Built – in Type (17bit)						
	Option	x						
Specifications and features	Protection method	Fully enclosed self-cooling IP67 (excluding shaft penetration part)						
	Time rating	Continuous						
	Ambient temperature	Use temperature: 0~40 [°C], maintenance temperature: -10~60 [°C]						
	Ambient humidity	Use humidity: 80[%] RH, maintenance humidity: 90[%] RH or lower (no condensation)						
	Atmosphere	No direct sunlight or corrosive or combustible gas						
	Anti-vibration	Vibration acceleration 49 [m/s <sup>2</sup> ] (5G)						
Weight	[kg]	1.23	2.09	2.63	2.75			

### ◆ Rotation velocity - Torque characteristics [■: 3-phase AC200V, ▨: 3-phase AC230V]

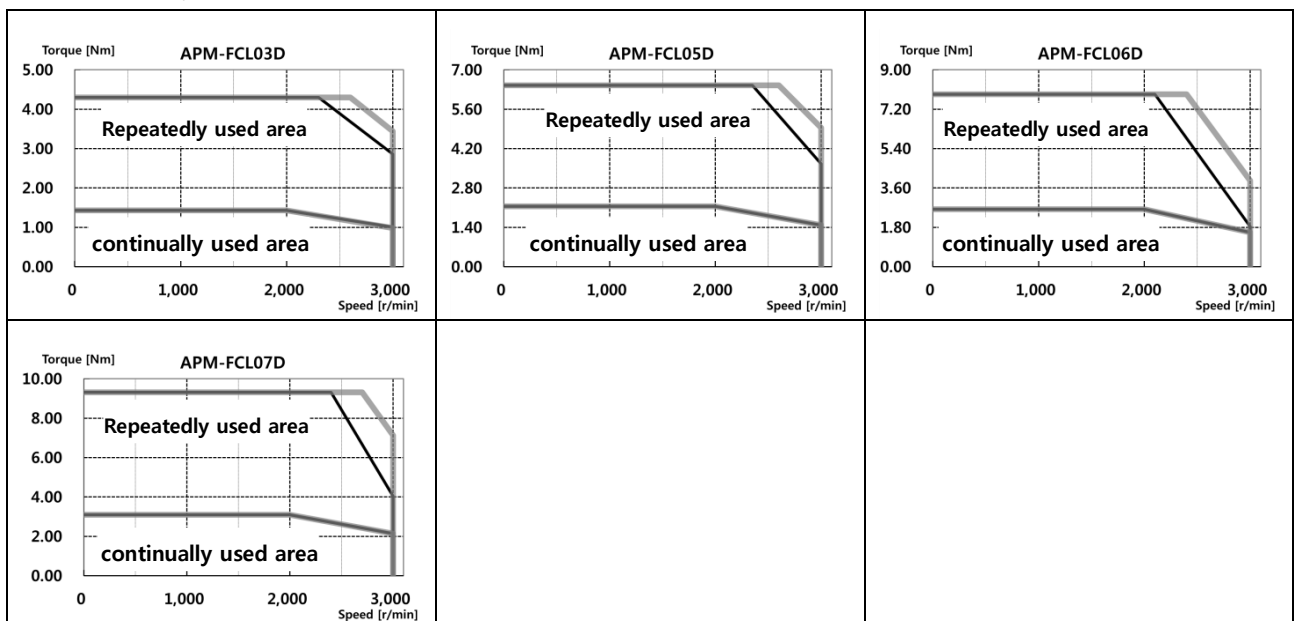



## ■ Electronic Brake Specifications

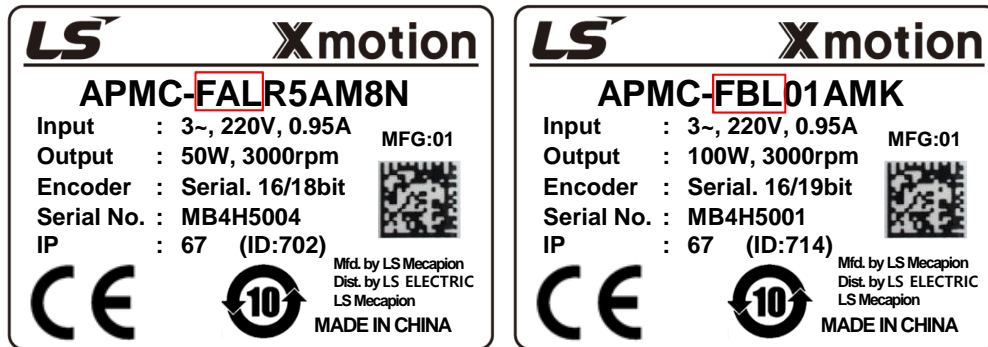

Applicable Motor Series	FAL	FBL	FCL
Purpose	Maintenance	Maintenance	Maintenance
Input voltage [V]	DC 24V	DC 24V	DC 24V
Statical friction torque [N·m]	0.32	1.47	3.23
Capacity [W]	6	6.5	9
Coil resistance [ $\Omega$ ]	96	89	64
Rated current [A]	0.25	0.27	0.38
Braking method	Spring brake	Spring brake	Spring brake
Insulation grade	Grade F	Grade F	Grade F

- Note 1)** The same specifications apply to all electric brakes installed in our servo motors.
- Note 2)** Electric brakes are designed to maintain a stop. Never use them for absolute braking.
- Note 3)** The characteristics of the electric brakes were measured at 20°C.
- Note 4)** These brake specifications are subject to change. Check the voltage specifications shown on your specific motor.
- Note 5)** FAL, FBL, FCL Series brakes satisfy UL specification class 2.



■ FBL Series | APM – FBL01A, FBL02A, FBL04A (17 bit magnetic encoder)

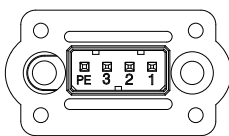
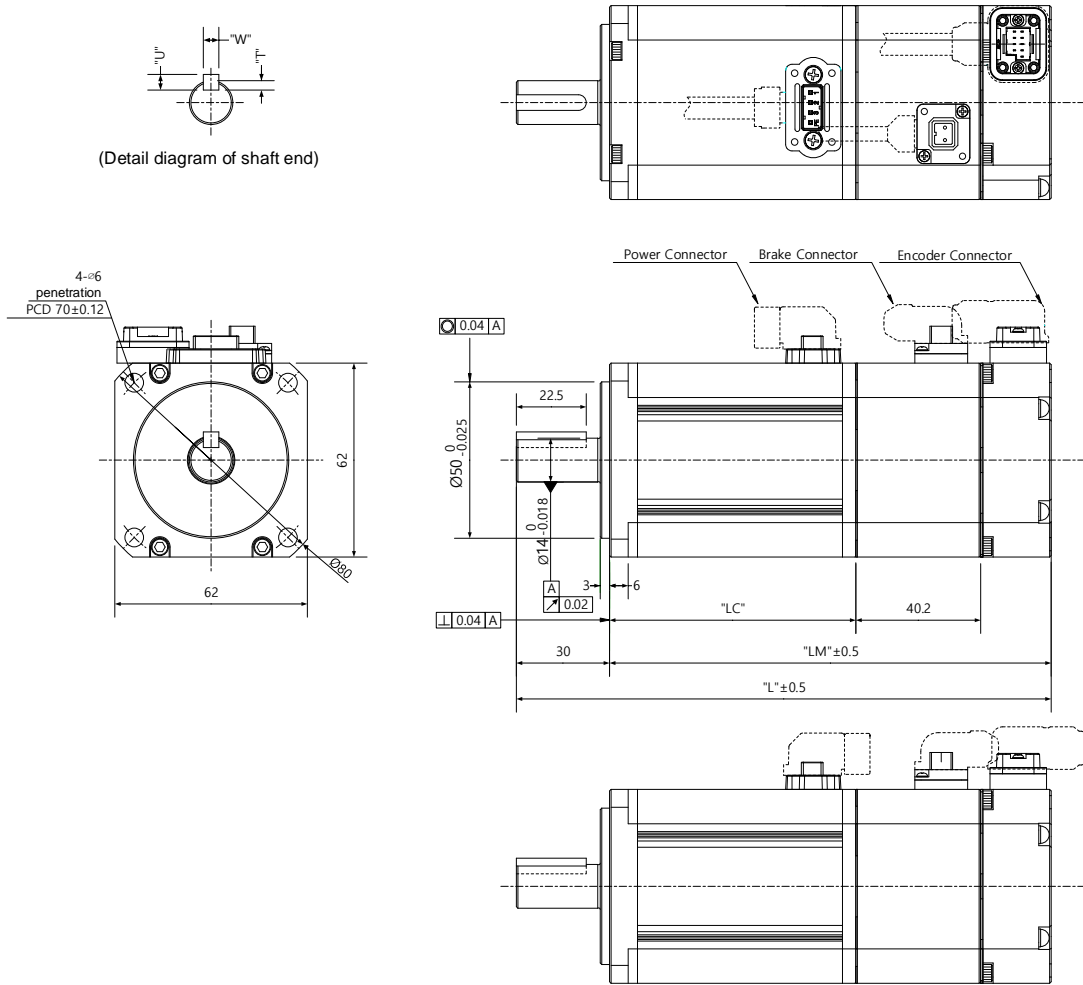

Pin No.	Phase
1	U
2	V
3	W
PE	FG

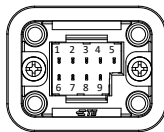

Pin No.	Signal	Pin No.	Signal
1	MA	6	/MA
2	SLO	7	/SLO
3	-	8	-
4	0V	9	+5V
5	Shield		

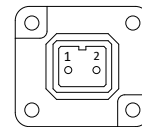

Pin No.	Phase
1	BK+
2	BK-

<Power connector pin arrangement>

<Encoder connector pin arrangement>

<Brake connector pin arrangement>

Model Name	External Dimensions					Key Dimensions			Weight (kg)
	L	LM	LC	S	H	T	W	U	
FBL01A	101.2 (141.2)	71.2 (111.2)	48.5 (48.3)	14	-0.018	5	5	3	0.54 (1.28)
FBL02A	112.2 (152.2)	82.2 (122.2)	59.5 (59.3)	14	-0.018	5	5	3	0.72 (1.46)
FBL04A	132.2 (172.2)	102.2 (142.2)	79.5 (79.3)	14	-0.018	5	5	3	1.04 (1.78)

**Note 1)** Use DC 24 [V] for the power to open the brake.

**Note 2)** The size in parentheses is of an attachable brake.

■ FCL Series | APM - FCL04A, FCL03D, FCL06A, FCL05D, FCL08A, FCL06D, APM - FCL10A, FCL07D  
(17 bit magnetic encoder)

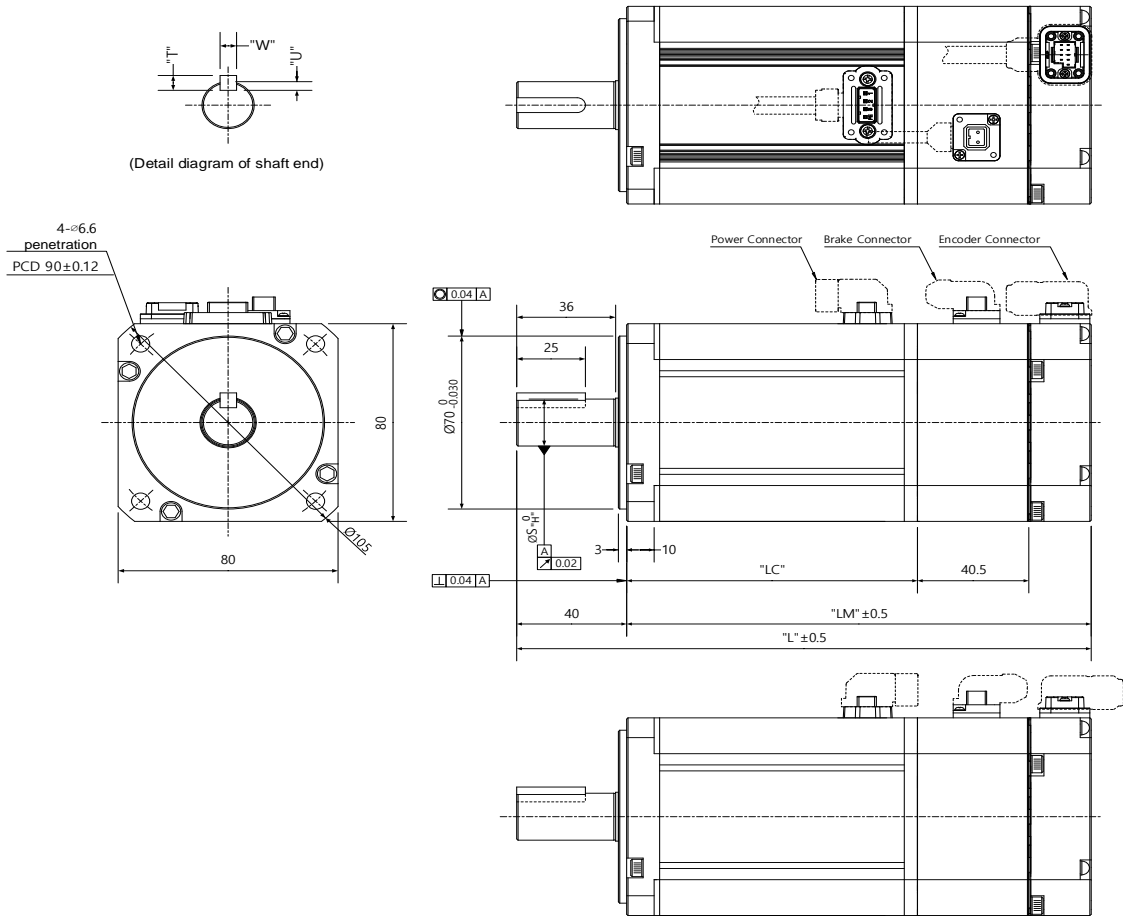

<When the cable withdraw direction is the opposite of the shaft>

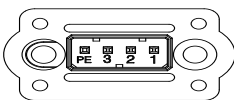

Pin No.	Phase
1	U
2	V
3	W
PE	FG

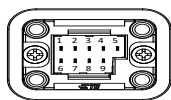

Pin No.	Signal	Pin No.	Signal
1	MA	6	/MA
2	SLO	7	/SLO
3	-	8	-
4	0V	9	+5V
5	Shield		

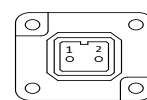

Pin No.	Phase
1	BK+
2	BK-

<Power connector pin arrangement>

<Encoder connector pin arrangement>

<Brake connector pin arrangement>

Model Name	External Dimensions					Key Dimensions			Weight (kg)
	L	LM	LC	S	H	T	W	U	
FCL04A, FCL03D	132.7 (173)	92.7 (133)	70 (69.8)	14	-0.018	5	5	3	1.49 (2.29)/1.23 (2.03)
FCL06A, FCL05D	150.7 (191)	110.7 (151)	88 (87.8)	19	-0.021	6	6	3.5	2.11 (2.91)/2.09 (2.89)
FCL08A, FCL06D	168.7 (209)	128.7 (169)	106 (105.8)	19	-0.021	6	6	3.5	2.65 (3.45)/2.63 (3.43)
FCL10A, FCL07D	186.7 (227)	146.7 (187)	124 (123.8)	19	-0.021	6	6	3.5	3.27 (4.07)/2.75 (3.55)

Note 1) Use DC 24 [V] for the power to open the brake.

Note 2) The size in parentheses is of an attachable brake.

## 2.2 Servo Drive

### 2.2.1 Product Features

Item		Model Name	L7CA001U	L7CA002U	L7CA004U	L7CA008U	L7CA010U
		Input Power	Single-Phase AC200 ~ 230[V](-15 ~ +10[%]), 50 ~ 60[Hz]				
Rated current [A]			1.4	1.7	3.0	5.2	6.75
Peak Current [A]			4.2	5.1	9.0	15.6	20.25
Encoder Type	Quadrature (Incremental) BiSS-B, BiSS-C (Absolute, Incremental)						
Control Performance	Velocity Control Range	1:5000 Maximum					
	Frequency Response	Maximum 1[kHz] (for a 19-bit serial encoder)					
	Velocity Variation	±0.01[%] or lower (when the load changes between 0~100[%]) ±0.1[%] or lower (temperature 25±10[°C])					
	Acceleration/Deceleration Time	Straight or S-curve acceleration/deceleration(possible to set the unit to 0~10,000[ms] or 0~1,000[ms])					
	Input frequency	1 [Mpps], line drive/200 [kbps], open collector					
	Input pulse method	Symbol+pulse series, CW+CCW, A/B phase					
RS422 Communication Specifications	Communication Standard	ANSI/TIA/EIA-422 Standard					
	Communication Protocol	MODBUS-RTU					
	Synchronization	Asynchronous					
	Transmission Rate	9600/19200/38400/57600 [bps] Possible to set in [0x3002]					
	Transmission Distance	Up to 200[m]					
	Current Consumption	100[mA] or lower					
	Terminating Resistance	External connector connected (CN1 7Pin, 28Pin), Built-in 120Ω					
Digital Input/Output	Digital Input	Input voltage range: DC 12[V] ~ DC 24 [V] 10 input channels in total (assignable) Possible to selectively assign up to 34 functions (*SV_ON, *SPD1/LVSF1, *SPD2/LVSF2, *SPD3, *A-RST, *JDIR, *POT, *NOT, *EMG, *STOP, START, REGT, HOME, HSTART, ISEL0, ISEL1, ISEL2, ISEL3, ISEL4, ISEL5, PCON, GAIN2, P_CL, N_CL, MODE, PAUSE, ABSRQ, JSTART, PCLR, AOV, INHIBIT, EGEAR1, EGEAR2, ABS_RESET) Note) * Indicates signals assigned by default.					

## 2. Product features

	Digital Output	<p>Rated voltage and current: DC 24[V] <math>\pm</math>10%, 120[mA]</p> <p>5 out of 8 channels are assignable 3 channels are fixed with AL00, AL01, AL02 signals.</p> <p>Possible to selectively assign up to 19 outputs (*ALARM, *READY, *ZSPD<math>\pm</math>, *BRAKE, *INPOS1, ORG, EOS, TGON, TLMT, VLMT, INSPD, WARN, INPOS2, IOUT0, IOUT1, IOUT2, IOUT3, IOUT4, IOUT5)</p> <p>Note) * Indicates signals assigned by default</p>
	Analog Input	<p>2 input channels in total</p> <p>Analog velocity input (Command/Override) -10[V] ~ +10[V]</p> <p>Analog torque input (Command/Limit) -10[V] ~ +10[V]</p>
USB Communi- cation	Function	Firmware download, parameter setting, adjustment, auxiliary functions and parameter copy function.
	Communication Standard	Compliant with the USB 2.0 Full Speed standard
	Connectible Device	PC or USB storage medium
Built-in Function	Dynamic Braking	Standard built-in (activated when the servo alarm goes off or when the servo is off)
	Regenerative Braking	External installation possible
	Display Function	7 segments (5 DIGITS)
	Add-on Functions	Gain adjustment, alarm history, jog operation, home search
	Protection Function	Overcurrent, overload, current limit over, overheat, overvoltage, undervoltage, encoder error, position following error, current sensing error, etc.
Use Environm- ent	Operating Temperature /Maintenance Temperature	0~50[°C] /-20~65[°C]
	Operating Humidity /Maintenance Humidity	80[%] RH or lower (No condensation) /90[%] RH or lower (No condensation)
	Humidity	
	Others	Indoor areas free from corrosive or combustible gases, liquids, or conductive dust

## 2.2.2 External View

### ■ L7CA001□ ~ L7CA004□

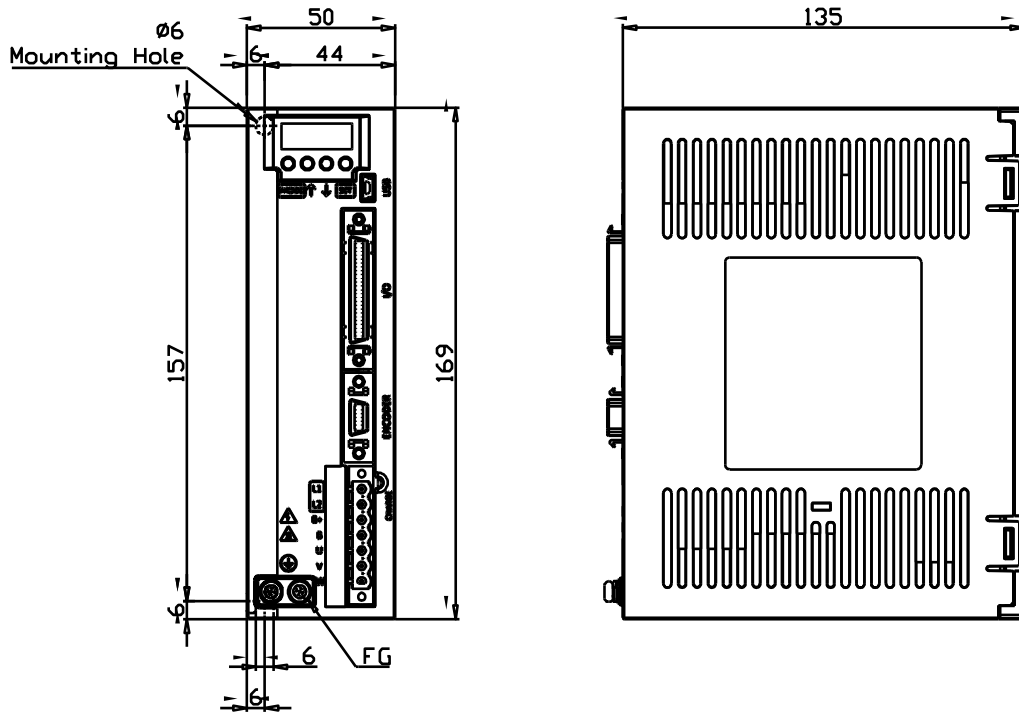

★ Weight: 1.0[kg]

### ■ L7□A008□ / L7□A010□

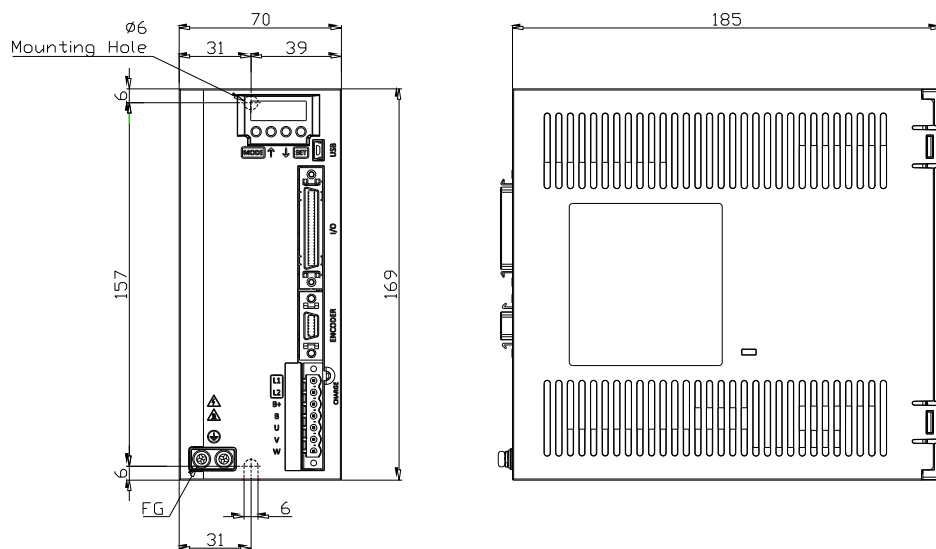

★ Weight: 1.5 [kg] (including the cooling fan)

## 2.3 Options and Peripheral Devices

■ Option Specification (Incremental Encoder Cable)

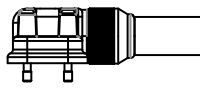
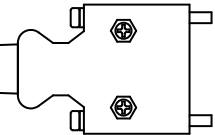
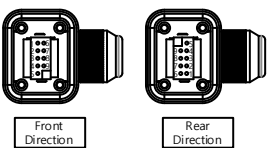
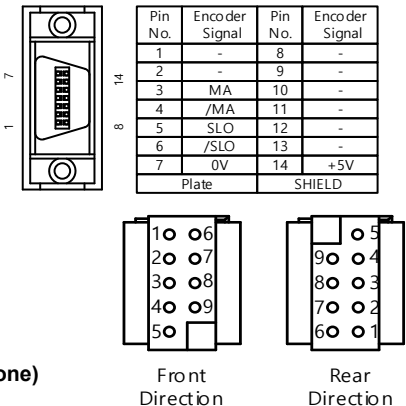
Classification	For Signals	Product Name	Low capacity serial encoder cable for flat motor (single-turn)																									
Model Name (Note 1)	APCS- E□□□ES (Front Direction)/ APCS- E□□□ES-R (Rear Direction)	Applicable Motor	All APM-FBL/FCL SERIES S-turn models																									
Specification																												
																												
<table border="1" data-bbox="630 851 909 996"> <thead> <tr> <th>Pin No.</th> <th>Encoder Signal</th> <th>Pin No.</th> <th>Encoder Signal</th> </tr> </thead> <tbody> <tr> <td>1</td> <td>MA</td> <td>6</td> <td>/MA</td> </tr> <tr> <td>2</td> <td>SLO</td> <td>7</td> <td>/SLO</td> </tr> <tr> <td>3</td> <td>-</td> <td>8</td> <td>-</td> </tr> <tr> <td>4</td> <td>0V</td> <td>9</td> <td>+5V</td> </tr> <tr> <td>5</td> <td>SHIELD</td> <td></td> <td></td> </tr> </tbody> </table>					Pin No.	Encoder Signal	Pin No.	Encoder Signal	1	MA	6	/MA	2	SLO	7	/SLO	3	-	8	-	4	0V	9	+5V	5	SHIELD		
Pin No.	Encoder Signal	Pin No.	Encoder Signal																									
1	MA	6	/MA																									
2	SLO	7	/SLO																									
3	-	8	-																									
4	0V	9	+5V																									
5	SHIELD																											
<p><b>1. Motor Connection</b></p> <p>a. CAP Model: 2201825-1 (Tyco)</p> <p>b. SOCKET Model: 2174065-4 (Tyco)</p> <p><b>2. Drive Connection (CN2)</b></p> <p>a. CASE Model: 10314-52A0-008 (3M) or SM-14J (Suntone)</p> <p>b. CONNECTOR Model: 10114-3000VE (3M) or SM-14J (Suntone)</p> <p><b>3. Cable Model: 3Px0.2SQ or 3Px24AWG</b></p>																												

**Note 1)** □□□ in the model name indicates the type and length of the cable. Refer to the following table for the information.

Cable length (m)	3	5	10	20
Robot Cable	F03	F05	F10	F20
Regular Cable	N03	N05	N10	N20

■ Option Specifications (L series power cable- for L7C exclusively)

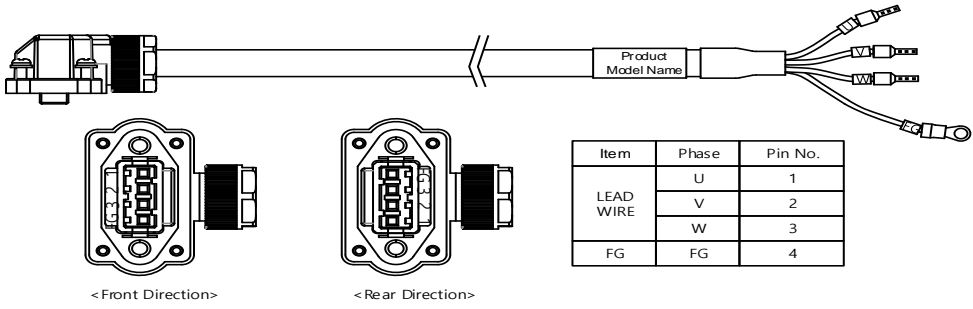

<b>Classification</b>	<b>For main power</b>	<b>Product Name</b>	<b>Low capacity L Series power cable</b>													
<b>Model Name (Note 1)</b>	APCS- P□□□LSC (Front Direction)/ APCS- P□□□LSC-R (Rear Direction)	<b>Applicable Motors</b>	<b>All APM-FAL/FBL/FCL Series models</b>													
<b>Specifications</b>	<p>Motor Side Connector <span style="float: right;">Dirve Side Connector</span></p>  <table border="1" data-bbox="1018 607 1291 730"> <thead> <tr> <th>Item</th> <th>Phase</th> <th>Pin No.</th> </tr> </thead> <tbody> <tr> <td rowspan="3">LEAD WIRE</td> <td>U</td> <td>1</td> </tr> <tr> <td>V</td> <td>2</td> </tr> <tr> <td>W</td> <td>3</td> </tr> <tr> <td>FG</td> <td>FG</td> <td>4</td> </tr> </tbody> </table> <p>&lt;Front Direction&gt; <span style="margin-left: 100px;">&lt;Rear Direction&gt;</span></p> <ol style="list-style-type: none"> <li>1. Motor connection             <ol style="list-style-type: none"> <li>a. PLUG model: SM-JN8FT04 (Suntone)</li> <li>b. Socket model: SMS-201 (Suntone)</li> </ol> </li> <li>2. Drive connection (U, V, W, PE)             <ol style="list-style-type: none"> <li>a. U, V and W pin model: 1506</li> <li>b. PE pin model: 1.5x4 (ring terminal)</li> </ol> </li> <li>3. Cable model: 4Cx0.75SQ or 4Cx18AWG</li> <li>4. Other: FAL products require encoder cable installation after power cable installation.</li> </ol>			Item	Phase	Pin No.	LEAD WIRE	U	1	V	2	W	3	FG	FG	4
Item	Phase	Pin No.														
LEAD WIRE	U	1														
	V	2														
	W	3														
FG	FG	4														

**Note 1)** □□□ in the model name indicates the type and length of the cable. Refer to the following table for the information.

Cable length (m)	3	5	10	20
Robot Cable	F03	F05	F10	F20
Regular Cable	N03	N05	N10	N20

■ Option specification (Cable)



■ Option Specifications (Braking Resistance)

Item	Product Name	Model Name	Applicable Drive	Specifications
Resistance	Braking Resistance	APCS-140R50	L7□A001□ L7□A002□ L7□A004□	<p>Technical drawing of the APCS-140R50 braking resistor. The top view shows a cylindrical component with a length of 188.35 mm and a diameter of 41 mm. A detail shows a diameter of 4.3 mm. The bottom view shows a trapezoidal base with a length of 144.36 mm and a height of 22 mm. The total length including the terminal block is 300 mm.</p>
Resistance	Braking Resistance	APCS-300R30	L7□A008□ L7□A010□	<p>Technical drawing of the APCS-300R30 braking resistor. The top view shows a cylindrical component with a length of 198 mm and a diameter of 17 mm. A detail shows a diameter of 5.3 mm. The bottom view shows a trapezoidal base with a length of 215 mm and a height of 60 mm. The total length including the terminal block is 500 mm. A detail of the terminal block shows a length of 30 mm.</p>



## 3. Wiring and Connection

### 3.1 Servo Motor Installation

#### ⚠ Caution

- If the encoder loses multi-turn data, there is a risk of equipment malfunction and accident, so be sure to perform origin operation before driving.
- When using an absolute encoder, the multi-turn data of the encoder will be lost if the following process is performed.
- When replacing motor and encoder cables.
- When replacing the battery with the servo power turned off.

#### 3.1.1 Operating Environment

Items	Environmental Conditions	Notes
Operating Temp.	0 ~ 40[°C]	Consult our technical support team to customize the product if the temperatures in the installation environment are outside this range.
Operating Humidity	80[%] RH or lower	Do not operate this device in an environment with steam.
External Vibration	Vibration acceleration 19.6[m/s <sup>2</sup> ] or below on X and Y axes	Excessive vibrations reduce the lifespan of the bearings.

#### 3.1.2 Preventing Over-impact

Impact onto the motor axis during installation or handling may cause the motor to fall and damage the encoder.

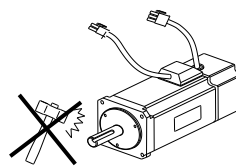

### 3.1.3 Motor Connection

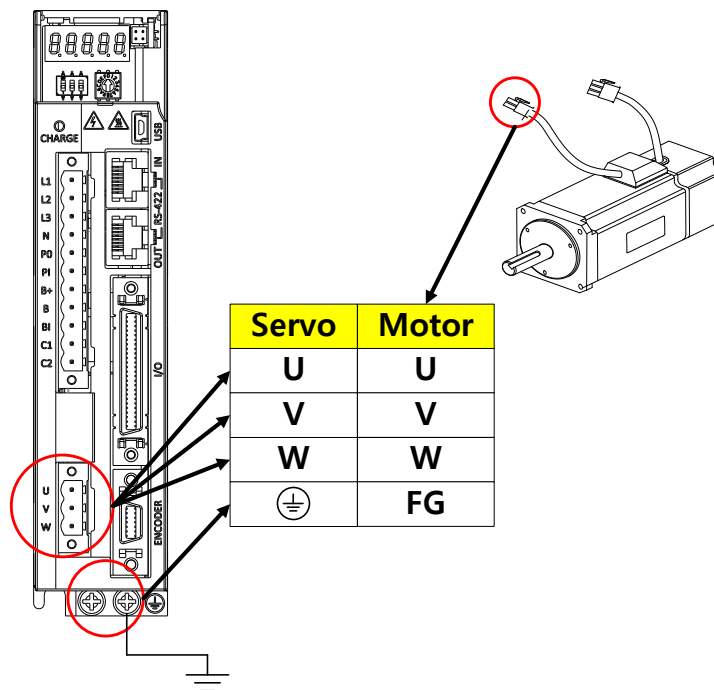

- Directly connecting the motor to a commercial power supply may burn the motor. Make sure to connect it with the specified drive before using it.
- Connect the ground terminal of the motor to either of the two ground terminals inside the drive, and attach the remaining terminal to the Type-3 ground.
- Connect U, V, and W terminals of the motor to match U, V, and W terminals of the drive.
- Ensure that no pin on the motor connector is fallen off or inadequately connected.
- If there is moisture or condensation on the motor, make sure that insulation resistance is 10[MΩ] (500[V]) or higher and install only if there is no abnormality.

#### ⚠ Caution

- Sometimes, if the motor's PE and the drive's PE terminal are not connected, DriveCM may not be properly connected when you turn on the servo or an AL-24 (motor disconnection) alarm may occur.
- PE and FG between the servo motor and the servo and between the servo and the device must be connected.

### 3.1.4 Load Device Connection

For coupling connections: Ensure that the motor shaft and the load shaft are aligned within the tolerance range.

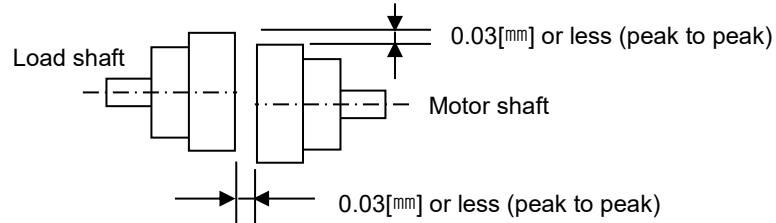

#### ■ For Pulley Connections:

Flange	Radial Load		Axial Load		Notes
	N	kgf	N	kgf	
40	148	15	39	4	<p>Nr: 30[mm] or less</p> <p>Radial load</p> <p>Axial load</p>
60	206	21	69	7	
80	255	26	98	10	
130	725	74	362	37	
180	1548	158	519	53	
220	1850	189	781	90	

### 3.1.5 Cable Installation

- For vertical installations, make sure that no oil or water flows into the connecting parts.

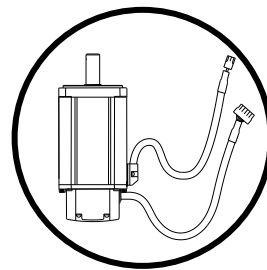
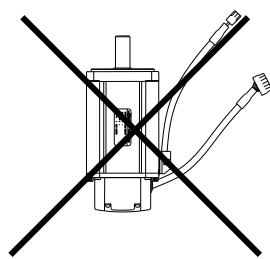

- Do not pressurize or damage the cables. Make sure to use robot cables for a moving motor and prevent the cables from swaying.

## 3.2 Servo Drive Installation

### 3.2.1 Installation and Usage Environment

Items	Environmental Conditions	Notes
Operating Temp.	0 ~ 50[°C]	<b>⚠ Caution</b> Install a cooling fan on the control panel for ventilation and to maintain the temperature within the range.
Operating Humidity	80[%] RH or below	<b>⚠ Caution</b> Moisture developed inside the drive due to ice formation or condensation during a prolonged period of inactivity may damage the drive. Remove all moisture before operating the drive after a prolonged period of inactivity.
External Vibration	Vibration acceleration 4.9[m/s <sup>2</sup> ] or lower	Excessive vibration reduces the lifespan of the product, and it may cause malfunctions.
Ambient Conditions		<ul style="list-style-type: none"> <li>▪ Do not expose the device to direct sunlight.</li> <li>▪ Do not expose the device to corrosive or combustible gases.</li> <li>▪ Do not expose the device to oil or dust.</li> <li>▪ Ensure that the device receives sufficient ventilation even if installed in a confined space.</li> </ul>



## 3.2.2 Installation with the Control Panel

Comply with the spacing standard specified in the following figures when installing with the control panel.

- When installing 1 unit:

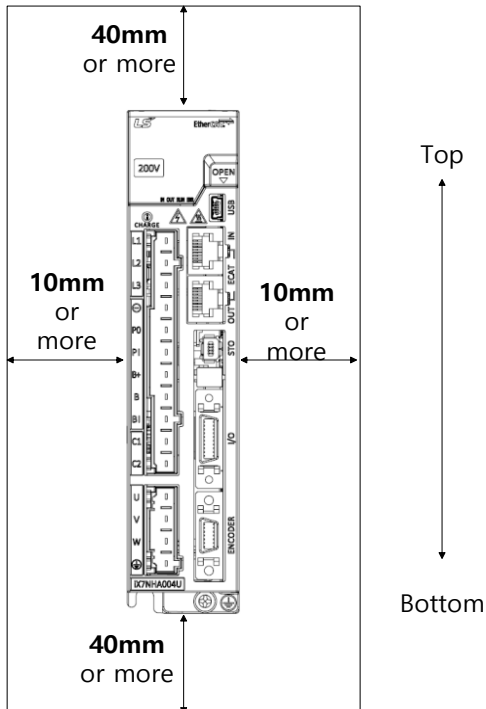

### ⚠ Caution

- Install the external regeneration brake resistor properly so that generated heat does not affect the drive.
- Assemble the servo drive control panel so it is flat against the wall.
- Do not let any metal debris generated from drilling, etc. fall into the drive when assembling the control panel.
- Make sure that oil, water, or metal dust does not enter the drive through the gaps or roof of the control panel.
- Protect the control panel by using air purge system when using it in an area where there are high amounts of harmful gases or dust.

■ When installing 2 or more units:

To prevent the temperature inside the control panel from exceeding the servo drive environmental conditions, install a cooling fan on the top of the servo drive. Also, refer to the picture below and leave sufficient space to allow for cooling by heat convection within the fan and control panel.

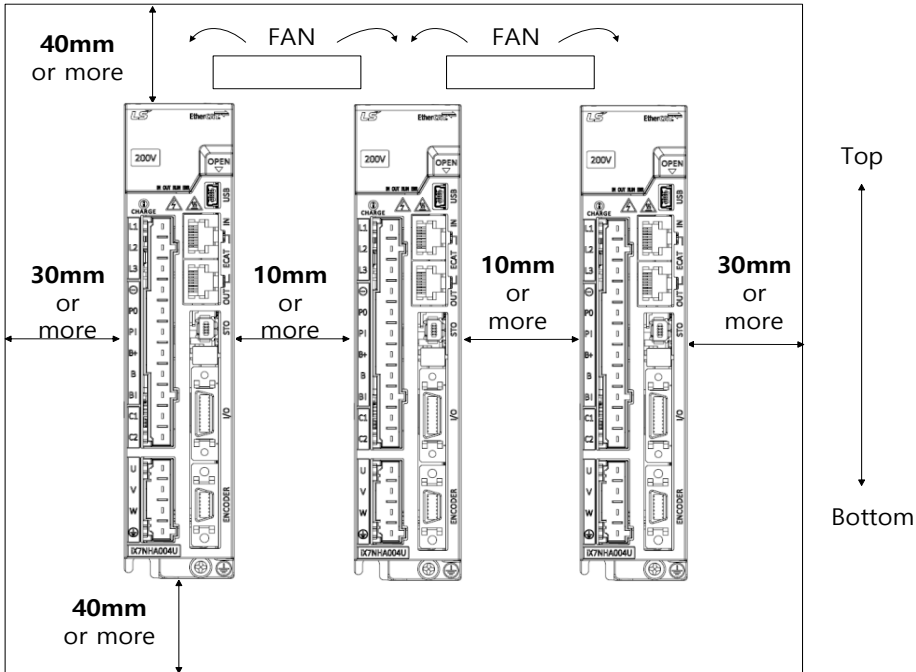

**⚠ Caution**

- Install the external regeneration brake resistor properly so that generated heat does not affect the drive.
- Assemble the servo drive control panel so it is flat against the wall.
- Do not let any metal debris generated from drilling, etc. fall into the drive when assembling the control panel.
- Make sure that oil, water, or metal dust does not enter the drive through the gaps or roof of the control panel.
- Protect the control panel by using air purge system when using it in an area where there are high amounts of harmful gases or dust.

## 3.3 Internal Block Diagram of the Servo Drive

### 3.3.1 Drive Block Diagram (100W ~ 1.0kW)

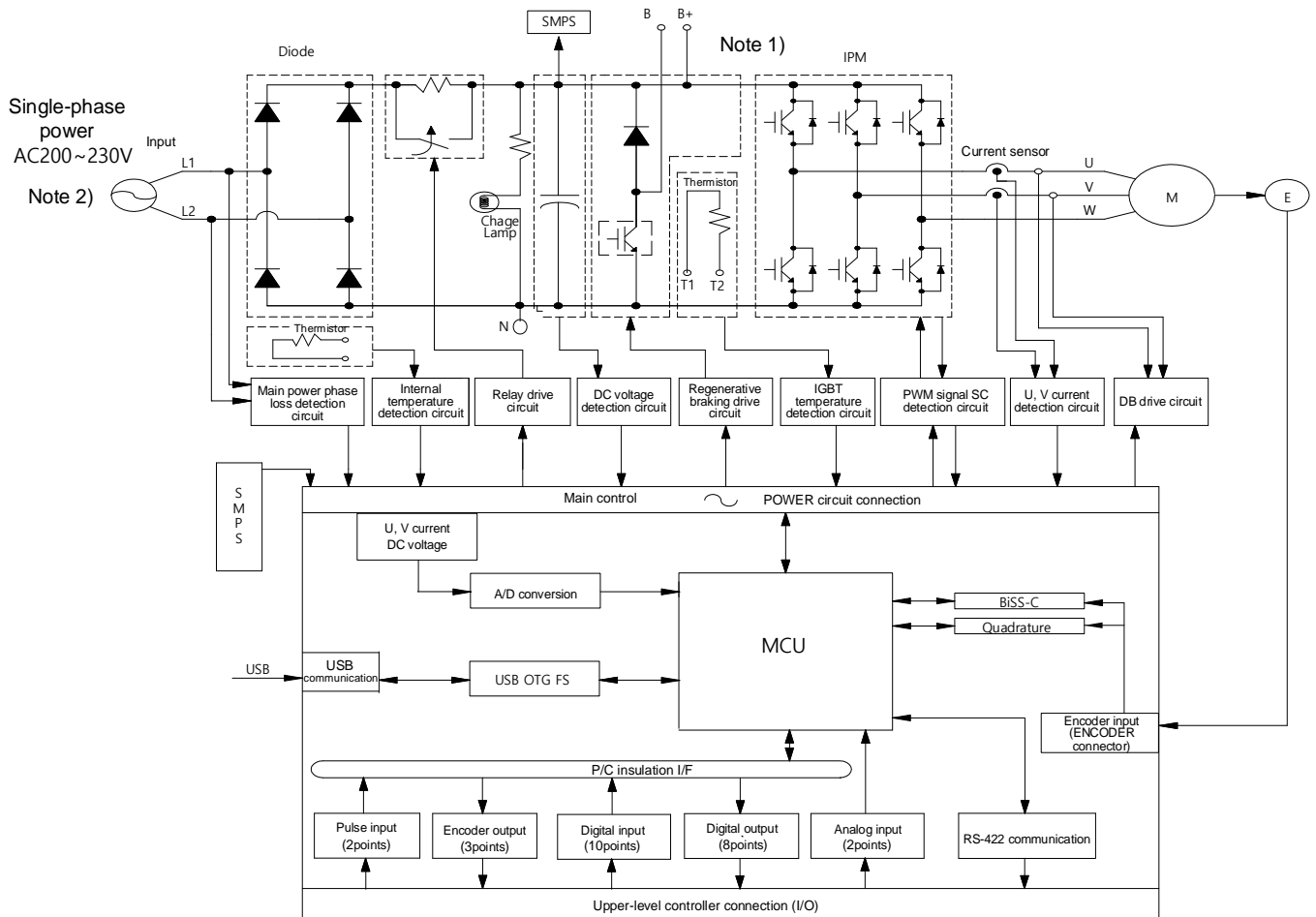

**Note 1)** Since there is no internal regenerative resistance, make sure to connect regenerative resistances to B+ and B pins.

**Note 2)** Connect a single-phase 220[V] supply.

## 3.4 Power Supply Wiring

- Ensure that the input power voltage is within the acceptable range.

<b>⚠ Caution</b>
Excessive voltage damages the drive.

- If a commercial power supply is connected to U, V and W terminals of the drive, the drive may be damaged. Make sure to connect the power to L1 and L2 terminals.
- Make sure to use the standard resistance values for the B+ and B terminals when using external regenerative resistance.

Models	Resistance Values	Standard Capacity	* Notes
100[W]	100[Ω]	External 50[W]	<b>⚠ Caution</b> For resistance values to use during regenerative capacity expansion, refer to Section 16.3, "Optional and Peripheral Devices."
200[W]			
400[W]			
800[W]	40[Ω]	External 100[W]	
1[kW]			

- High voltages may remain in the device for sometime even after the main power is disconnected. Be careful.

<b>⚡ Warning</b>
Before resuming wiring, make sure to disconnect the main power and that the charge lamp is completely turned off. Failure to do so may result in electric shock.

- Always ground the device using the shortest possible ground wire. Long ground wires are easily influenced by noise, which causes malfunctions.

### 3.4.1 Power Supply Wiring Diagram (100W ~ 1.0kW)

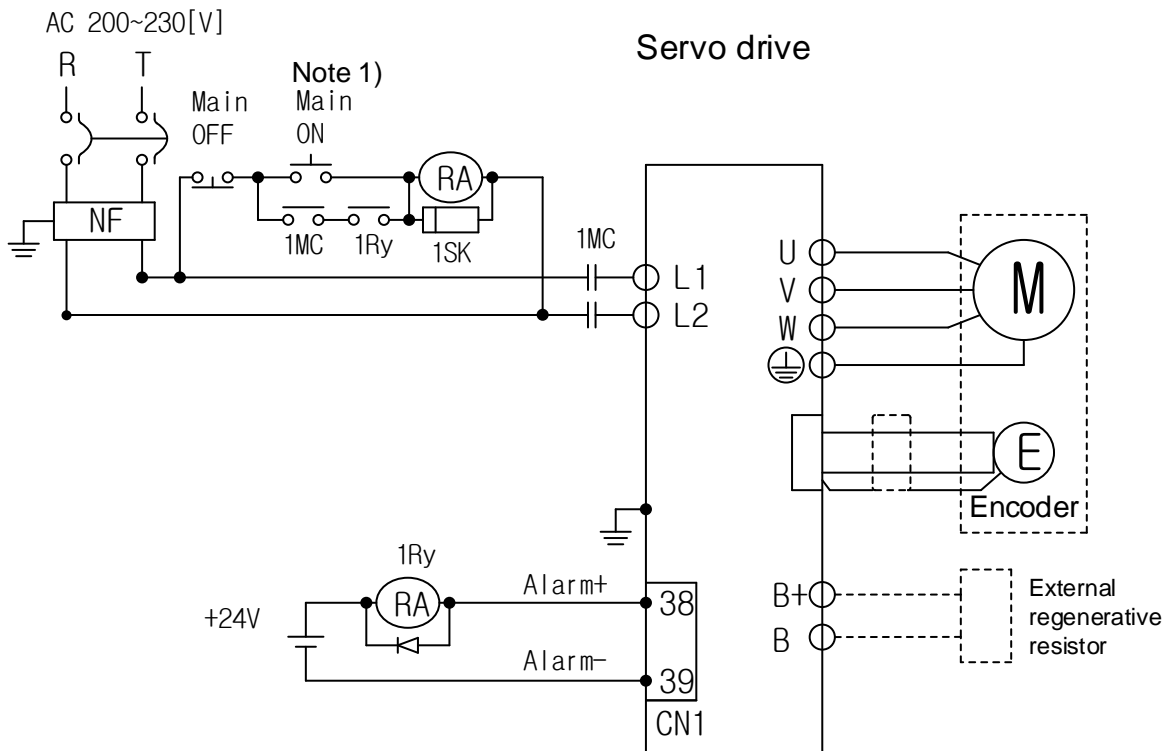

주1) About 1~2 seconds are required from main power supply to alarm signal output. Press the main power on switch and hold it for at least 2 seconds.

Connect a regenerative resistance of (50[W], 100[Ω]) for a 100[W]~400[W] drive and (100[W], 40[Ω]) for a 800[W]~1[kW] drive to external terminals B and B+.

Remove approximately 7 to 10[mm] of the sheathing from the cables for the main circuit power and use the dedicated pressurized terminals. (Refer to Section 2.4.3, "Power Circuit Electrical Component Standards.")

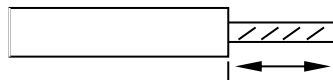

Use a (-) flathead screwdriver to connect or remove the main circuit power unit wires.

## 3.4.2 Power Input Sequence

### ■ Power Input Sequence

- For wiring of the main power, use a magnetic contactor for the main circuit power as shown in Section 2.4.1, "Power Supply Wiring Diagram." Set the magnetic contactor to be turned off simultaneously with an alarm occurrence in the external sequence.
- The alarm signal is turned on (normal state) about 2.5 seconds after power supply, then the servo on command signal is recognized. Accordingly, if the servo on command signal is on during power supply, the actual servo on operation begins after about 2.5 seconds. Keep this in mind when designing the power input sequence.

### ■ Timing Chart

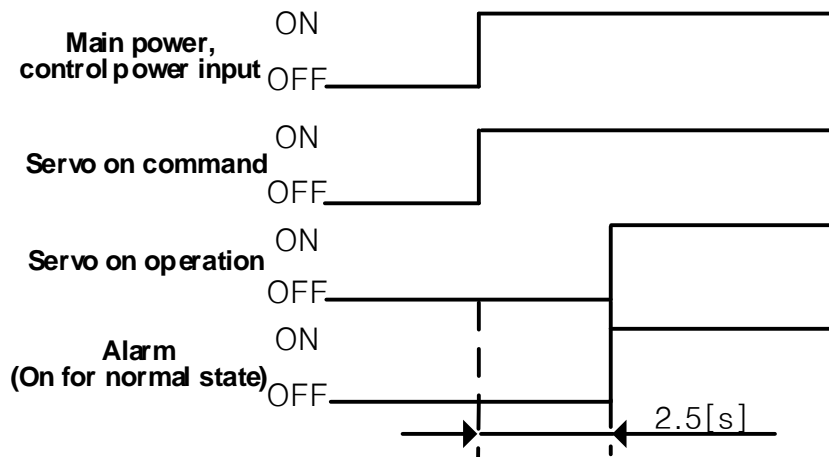

### 3.4.3 Power Circuit Electrical Component Standards

Model Names	100W	200W	400W	800W	1kW
MCCB (NFB)	30A Frame 5A		30A Frame 10A	30A Frame 15A	
Noise Filter (NF)	TB1-10A0D0 (10A)				
DC Reactor	HFN-10 (10A)			HFN-15 (15A)	
MC	11A/240V (GM□-9)			18A/240V (GM□-18)	
L1, L2, B+, B, U, V, W note 1)	AWG16 (1.5 mm <sup>2</sup> )				
Pressurized Terminal	Ferrule 16AWG (6mm Strip & Twist)				
Connector	BCP-508F- 7 GN				

Note1) Select and use 600V, PVC-insulated wires.

To comply with UL (CSA) standards, use UL-certified wires that have a heat resistant temperature of 75°C or above.

To comply with other standards, use proper wires that meet the applicable standards.

For other special specifications, use wires equivalent or superior to those specified in this Section.

## 3.5 Wiring for Input/Output Signals

### ■ CN1 Connector Model (I/O Drive Connection)

▶ CASE Model: 10350-52A0-008 (3M)

▶ CONNECTOR Model: 10150-3000VE(3M)

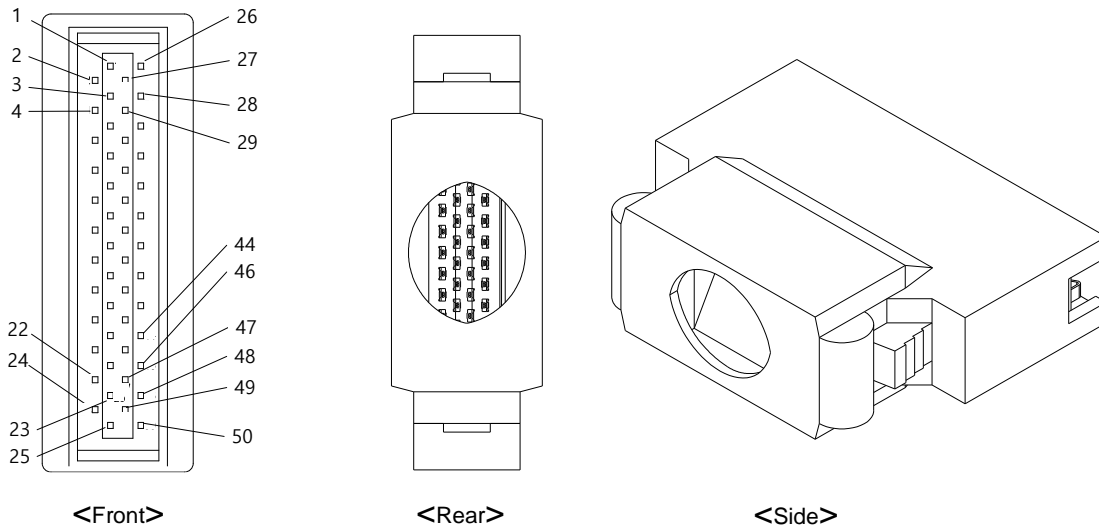



## 3.5.1 Names and Functions of Digital Input/Output Signals

### ■ Names and Functions of Digital Input Signals (CN1 Connector)

Pin Numbers	Names	Assignments	Description	Functions																																							
50	+24V	DC 24V	DC 24 V input	Common																																							
47	DI 1	SVON	Servo On	The motor becomes operable when the SVON signal is turned on (Servo On state). The motor enters the free-run state when the signal is off.																																							
23	DI 2	SPD1	Multi-velocity 1	Selects the rotation velocity command for velocity-limited operation. The velocity command changes as shown below according to the status of the contacts.																																							
22	DI 3	SPD2	Multi-velocity 2																																								
21	DI 4	SPD3	Multi-velocity 3	<table border="1"> <thead> <tr> <th colspan="3">Input Devices</th> <th rowspan="2">Velocity</th> </tr> <tr> <th>SPD1</th> <th>SPD2</th> <th>SPD3</th> </tr> </thead> <tbody> <tr> <td>X</td> <td>X</td> <td>X</td> <td>Multi-velocity command 1 (Parameter 0x2312)</td> </tr> <tr> <td>O</td> <td>X</td> <td>X</td> <td>Multi-velocity command 2 (Parameter 0x2313)</td> </tr> <tr> <td>X</td> <td>O</td> <td>X</td> <td>Multi-velocity command 3 (Parameter 0x2314)</td> </tr> <tr> <td>O</td> <td>O</td> <td>X</td> <td>Multi-velocity command 4 (Parameter 0x2315)</td> </tr> <tr> <td>X</td> <td>X</td> <td>O</td> <td>Multi-velocity command 5 (Parameter 0x2316)</td> </tr> <tr> <td>O</td> <td>X</td> <td>O</td> <td>Multi-velocity command 6 (Parameter 0x2317)</td> </tr> <tr> <td>X</td> <td>O</td> <td>O</td> <td>Multi-velocity command 7 (Parameter 0x2318)</td> </tr> <tr> <td>O</td> <td>O</td> <td>O</td> <td>Multi-velocity command 8 (Parameter 0x2319)</td> </tr> </tbody> </table>	Input Devices			Velocity	SPD1	SPD2	SPD3	X	X	X	Multi-velocity command 1 (Parameter 0x2312)	O	X	X	Multi-velocity command 2 (Parameter 0x2313)	X	O	X	Multi-velocity command 3 (Parameter 0x2314)	O	O	X	Multi-velocity command 4 (Parameter 0x2315)	X	X	O	Multi-velocity command 5 (Parameter 0x2316)	O	X	O	Multi-velocity command 6 (Parameter 0x2317)	X	O	O	Multi-velocity command 7 (Parameter 0x2318)	O	O	O	Multi-velocity command 8 (Parameter 0x2319)
				Input Devices			Velocity																																				
				SPD1	SPD2	SPD3																																					
				X	X	X	Multi-velocity command 1 (Parameter 0x2312)																																				
				O	X	X	Multi-velocity command 2 (Parameter 0x2313)																																				
				X	O	X	Multi-velocity command 3 (Parameter 0x2314)																																				
				O	O	X	Multi-velocity command 4 (Parameter 0x2315)																																				
				X	X	O	Multi-velocity command 5 (Parameter 0x2316)																																				
O	X	O	Multi-velocity command 6 (Parameter 0x2317)																																								
X	O	O	Multi-velocity command 7 (Parameter 0x2318)																																								
O	O	O	Multi-velocity command 8 (Parameter 0x2319)																																								
17	DI 5	A-RST	Alarm reset	Turns off the servo alarm.																																							
46	DI 6	JDIR	Selection of jog's rotational direction	Switches the rotational direction of jog operation.																																							

20	DI 7	POT	Forward (CCW) rotation prohibited	Stops the motor so that the actuator cannot move beyond the motion range in the forward rotational direction. The stopping method varies according to [0x2013] setting value.
19	DI 8	NOT	Reverse (CW) rotation prohibited	Stops the motor so that the actuator cannot move beyond the motion range in the reverse rotational direction. The stopping method varies according to the [0x2013] setting value.
18	DI 9	EMG	Emergency stop	When EMG signal is turned on, the servo initiates an emergency stop and generates "W-80." Here, the stopping method varies according to the [0x2013] setting value.
48	DI 10	STOP	Servo stop	Stops the operation.
** START			Operation start	Starts index location.
** REGT			Operation after sensing	If the index type is Registration Absolute or Registration Relative and REGT signal is on, it adopts the set operation velocity and moving distance to start operation.
HOME			Home position sensor	A home sensor input signal used in homing.
** HSTART			Homing start	Starts homing.
** ISEL0			Index Selection 0	Selects an index for operation from 0~63.
** ISEL1			Index Selection 1	
** ISEL2			Index Selection 2	
** ISEL3			Index Selection 3	
** ISEL4			Index Selection 4	
** ISEL5			Index Selection 5	
** PCON			P control action	Switches PI control to P control when PCON signal is turned on.
** GAIN2			Switching Gain 1 to Gain 2	Switches velocity-limiting Gain 1 to Gain 2 when Gain 2 signal is turned on.
** PCL			Forward torque limit	Enables torque limitation in the forward direction when PCL signal is turned on. It governs movements according to the [0x2110] setting and determines the torque limit values through [0x2111].
** NCL			Reverse torque limit	Enables torque limitation in the reverse direction when NCL signal is turned on. It governs movements according to the [0x2110] setting and determines the torque limit values through [0x2112].

** PAUSE	Pause	Decelerates and pauses index operation when the pause signal is input. It resumes the index operation when the pause signal is re-input during the paused state.
** ABSRQ	Absolute location data request	Upon request of the absolute data of the absolute encoder, the data of the absolute encoder is transmitted to a upper level controller in quadrature pulse format through AO, BO output.
** JSTART	Jog operation	When the contacts are turned on, it starts jog operation at the velocity set in [0x2300].
** PCLR	Input pulse clear	When the contacts are turned on, it does not receive input pulses and sets the position tolerance to 0. The operation mode can be set in [0x3005].
** AOVV	Select speed override	When AOVV signal is turned on, it overrides the index operation velocity according to the voltage value input in SPDCOM (AI2) The override value is set to 0% for an input of -10V, to 100% for 0V, and to 200% for +10V.
** MODE	Operation mode change	Changes the operation mode during operation.
** INHIBIT	Command pulse inhibition	Inhibits counting of input pulses during pulse input position operation as a command pulse.
** LVSF1	Vibration suppression filter 1	Vibration suppression filter signal 1 according to the vibration suppression filter function setting (0x2515). It is the same as SPD1 setting value during the assignment.
** LVSF2	Vibration suppression filter 2	Vibration suppression filter signal 2 according to the vibration suppression filter function setting (0x2515). It is the same as SPD2 setting value during the assignment.
** EGEAR1	Electric gear ratio 1	A signal for selecting the electric gear ratio of the parameter set during pulse input position operation.
** EGEAR2	Electric gear ratio 2	Refer to Section 10.3.4, "Electric Gear Ratio During Pulse Input Position Operation."
** ABS_RESET	Multi-turn data reset	Resets the multi-turn data value back to the initial value 0 to use the absolute encoder.

\*\*A signal not assigned by default in the factory setting. The assignment may be changed by parameter settings. For more information, refer to Section 10.2, "Input/Output Signals Setting."

Wiring can be also done by using COMMON (DC 24V) of the input signal as GND.

SPD1 and LVSF1 signals use the same setting values during assignment, as do SPD2 and LVSF2 signals, and the functions differ according to the operation mode (Velocity operation: SPD1, SPD2/position operation: LVSF1, LVSF2).

■ Names and Functions of Digital Output Signals (CN1 Connector)

Pin Numbers	Names	Assignments	Description	Functions
16	DO 6	ALO0	Alarm group contact output 1	Outputs the alarm group. ex) outputs ALO0 upon AL-10 occurrence Outputs ALO0, ALO1 upon AL-31 occurrence Outputs ALO2 upon AL-42 occurrence
15	DO 7	ALO1	Alarm group contact output 2	
14	DO 8	ALO2	Alarm group contact output 3	
38	DO 1+	ALARM	Servo alarm	Outputs the servo alarm that occurs
39	DO 1-			
40	DO 2+	RDY	Servo ready	Output when the main power is established and the preparations for servo operation are completed.
41	DO 2-			
43	DO 3	ZSPD	Zero speed reached	Output when 0rpm is reached.
44	DO 4	BRAKE	Brake	A signal for controlling the brakes installed inside or outside the motor. It is output when SVON contact is off.
45	DO 5	INPOS1	Position reached 1	A signal output when the command point is reached. The output conditions can be set by the setting values in [0x2401] and [0x2402].
** ORG			Homing complete	Output when homing is complete.
** EOS			Operation complete	Output when the index operation is complete.
** TGON			Rotation detection	Output when the motor rotates at a value beyond the value set in [0x2405].
** TLMT			Torque Limit	Output when the drive output is limited by the torque limit setting value.
** VLMT			Velocity limit	Output when the motor reaches the velocity limit. The velocity limit can be adjusted in [0x230D] and [0x230E] settings.

** INSPD	Velocity reached	Output when the difference between the velocity command and the current velocity is equal to or below the setting value in [0x2406].
** WARN	Servo warning	Outputs the servo warning that occurs.
** INPOS2	Position reached 2	A signal output when the command point is reached. The output conditions can be set by the setting values in [0x2403].
** IOUT0	Index Output 0	Outputs the index number currently in operation from 0~63.
** IOUT1	Index Output 1	
** IOUT2	Index Output 2	
** IOUT3	Index Output 3	
** IOUT4	Index output 4	
** IOUT5	Index Output 5	

\*\* Unassigned signal. The assignment may be changed by parameter settings. For more information, refer to Section 10.2, "Input/Output Signals Setting."

## 3.5.2 Names and Functions of Analog Input/Output Signals

### ■ Names and Functions of Analog Input Signals (CN1 Connector)

Pin Numbers	Names	Description	Functions
1	TRQCOM	Analog Torque Input (command/limit)	<p>Indexing Position Mode: Applies a voltage between -10 and +10V to between TRQCOM (AI1) and AGND to limit the motor output torque. The relationship between input voltage and torque limit depends on the value set in [0x2210].</p> <p>Torque Mode: Applies a voltage between -10 and +10V to between TRQCOM (AI) and AGND to give the analog torque command. The relationship between input voltage and torque command depends on the value set in [0x2210].</p>
27	SPDCOM	Analog Velocity Input (command/override)	<p>Indexing Position Mode: Applies a voltage between -10 and +10V to between SPDCOM (AI2) and AGND to override the index operation velocity. The override value is set to 0% for an input of -10V, to 100% for 0V, and to 200% for +10V. Whether or not to use the function can be selected in [0x220F] or by AOVR contact input.</p> <p>Velocity Mode: Applies a voltage between -10 and +10V to between SPDCOM (AI2) and AGND to perform analog velocity control. The relationship between input voltage and velocity command depends on the value set in [0x2229].</p>
8	AGND	AGND (0V)	Analog ground

### 3.5.3 Names and Functions of Pulse Train Input Signals

#### ■ Pulse Train Input Signals (CN1 Connector)

Pin Numbers	Names	Description	Functions
49	PULCOM	+24[V] power input	<p>Inputs a pulse train command.</p> <p>Inputs a forward rotation pulse train between PF+ and PF- and a reverse rotation pulse train between PR+ and PR-.</p> <p>It operates when Pulse Input Position is selected in [0x3000]. The position input pulse logic setting and pulse input filter setting can be changed in [0x3003] and [0x3004] respectively.</p> <p>The maximum input frequencies for the line drive method and the open collector method are 1Mpps and 200kpps respectively.</p> <p>The line drive method does not use PULCOM.</p>
9	PF+		
10	PF-		
11	PR+		
12	PR-		

### 3.5.4 Names and Functions of Encoder Output Signals

#### ■ Encoder Output Signals (CN1 Connector)

Pin Numbers	Names	Description	Functions
32	AO	Encoder Signal A	<p>Outputs de-multiplied encoder signals in A, B, and Z phases by the line drive method.</p> <p>The encoder signal output frequency of the drive is 4 [Mpps] at the maximum for the line drive method (X4 interpolation).</p> <p>The number of output pulses can be set in [0x3006].</p>
33	/AO		
30	BO	Encoder Signal B	
31	/BO		
4	ZO	Encoder Signal Z	
5	/ZO		

## 3.5.5 Examples of Input/Output Signal Connection

### ■ Examples of Digital Input Signal Connection

#### ⚠ Caution

3. You can set the input contact to contact A or contact B, based on the characteristics of individual signals.
4. You can assign each input contact to one of 31 functions.
5. For more information on signal assignment and change of the input contact, refer to Section 10.2, "Input/Output Signals Setting."
6. The rated voltage is DC 12V to DC 24V.

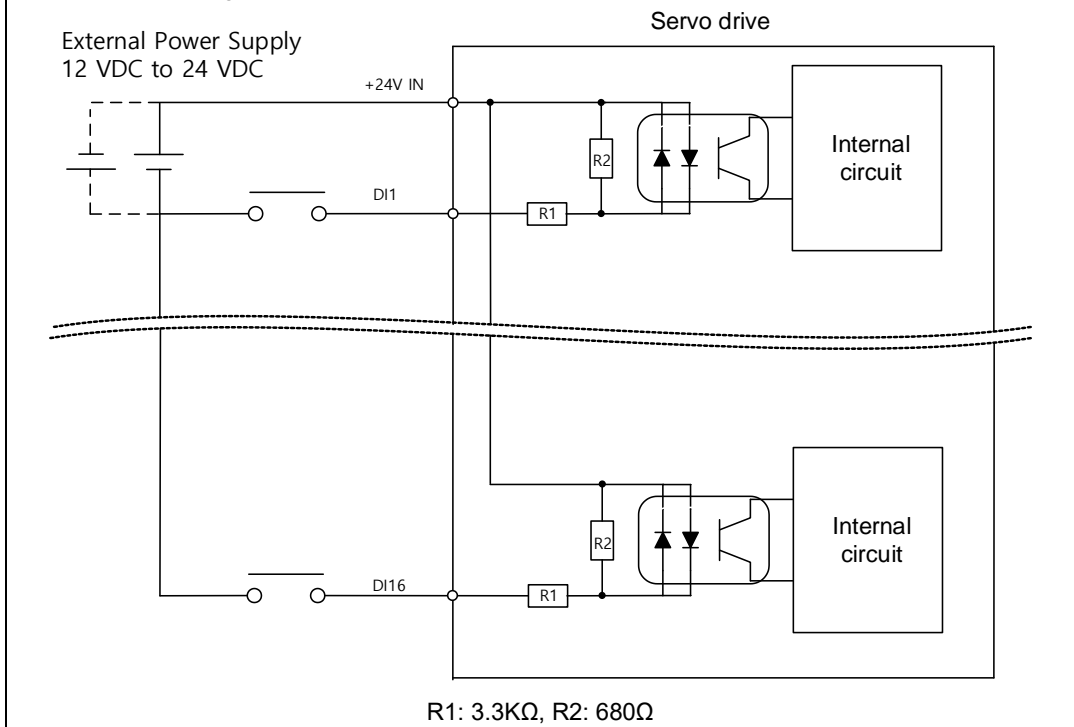



## ■ Examples of Digital Output Signal Connection

### ⚠ Caution

7. You can set the output contact to contact A or contact B, based on the characteristics of individual signals.
8. You can assign each output contact to one of 19 output functions.
9. For more information on signal assignment and change of the output contact, refer to Section 10.2, "Input/Output Signals Setting."
10. Excessive voltage or overcurrent may damage the device because it uses an internal transistor switch. Be cautious.
11. The rated voltage and current are DC 24V ± 10% and 120[mA].

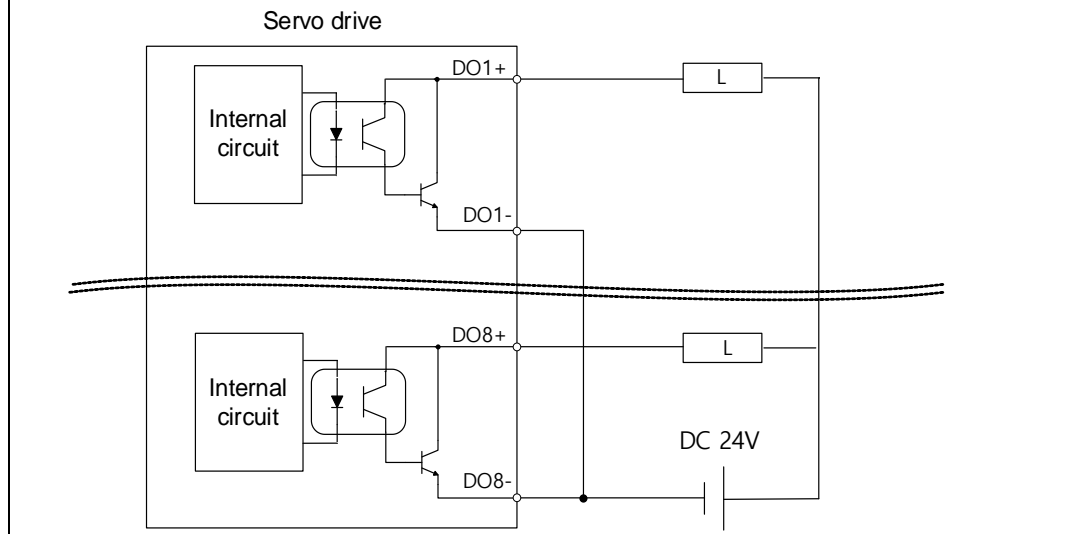

**Note 1)** DO1 and DO2 outputs use separated GND24 terminals, and DO3~DO8 outputs use a common GND24 for DOCOM.

**Note 2)** DO6~DO8 outputs are locked for alarm group outputs. You can assign desired output signals to DO1~DO5 outputs for use.

■ Examples of Analog Input Signal Connection

**⚠ Caution**

- 12. For information on how to operate analog input signals, refer to Section 4.5, "Analog Velocity Override," Section 6.2, "Analog Velocity Command," Section 7.2, "Analog Torque Command Scale," and Section 10.8, "Torque Limit Function."
- 13. The range of analog output signals is -10V~10V.
- 14. The impedance for input signals is approximately 10KΩ.

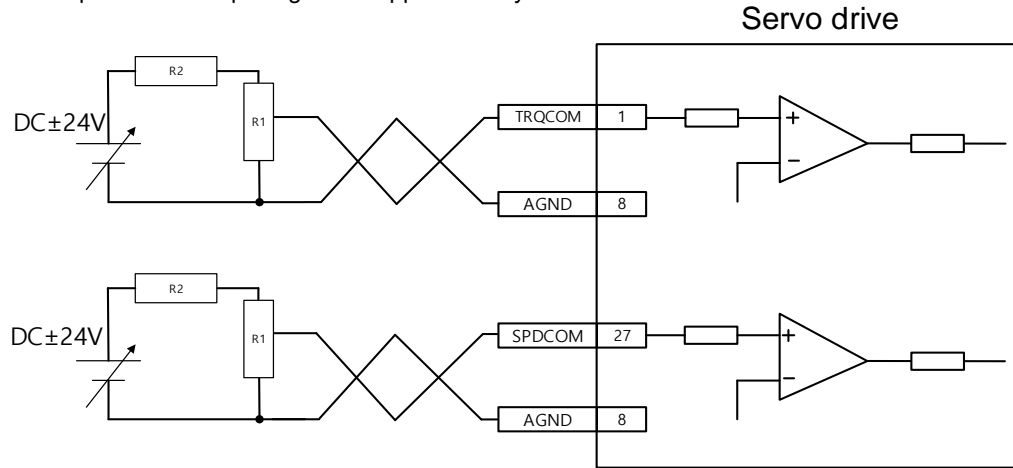

4. Example of resistance selection for use of 24V for input voltage

No	R1	R2
1	5KΩ	6KΩ
2	10KΩ	12KΩ

5. Examples of using internal +12V and -12V power sources

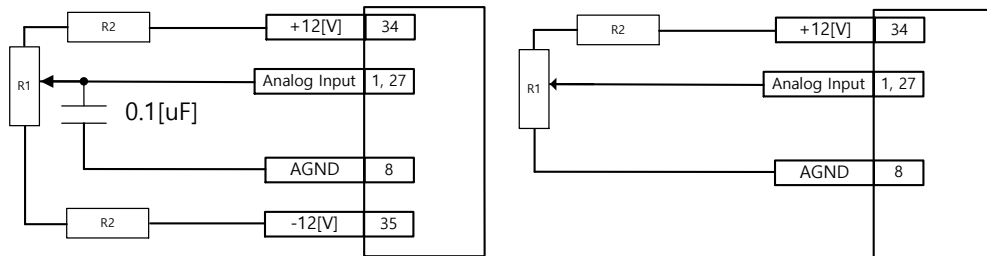

No	R1	R2
1	10KΩ	660Ω
2	5KΩ	330Ω
3	2KΩ	132Ω

## 3.5.6 Pulse Train Input Signal

### ■ Line Drive (5[V]) Pulse Input

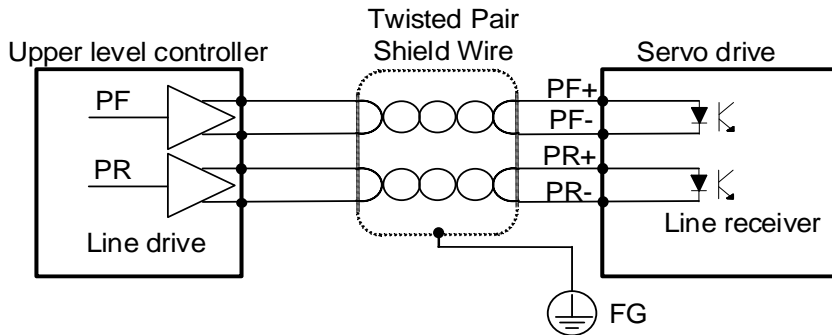

### ■ Open Collector (24[V]) Pulse Input

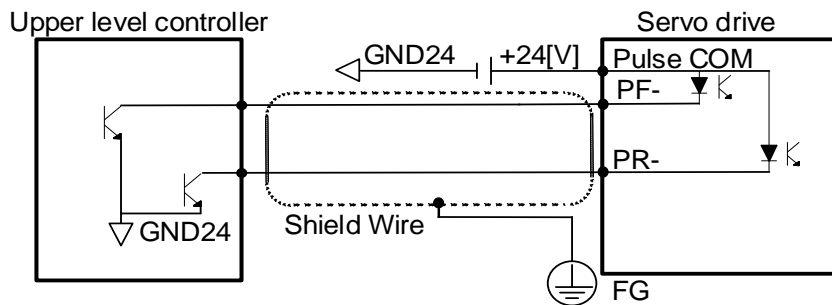

### ■ 12[V] or 5[V] NPN Open Collector Pulse Command

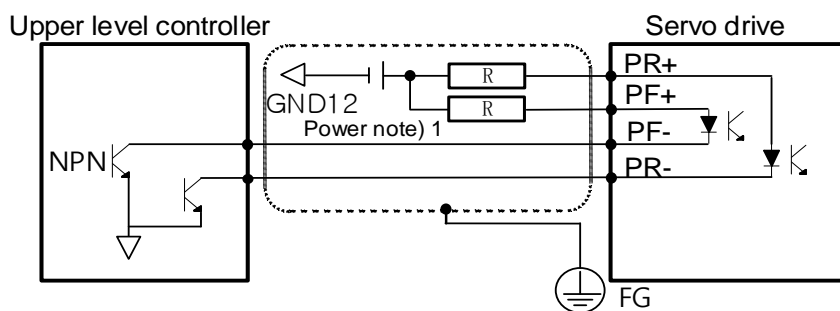

**Note 1)** When using 5[V] power: Resistance R = 100-150[Ω], 1/2[W]

When using 12[V] power: Resistance R = 560-680[Ω], 1/2[W]

When using 24[V] power: R = 1.5[kΩ], 1/2[W]

### 3.5.7 Input/Output Signals Configuration Diagram

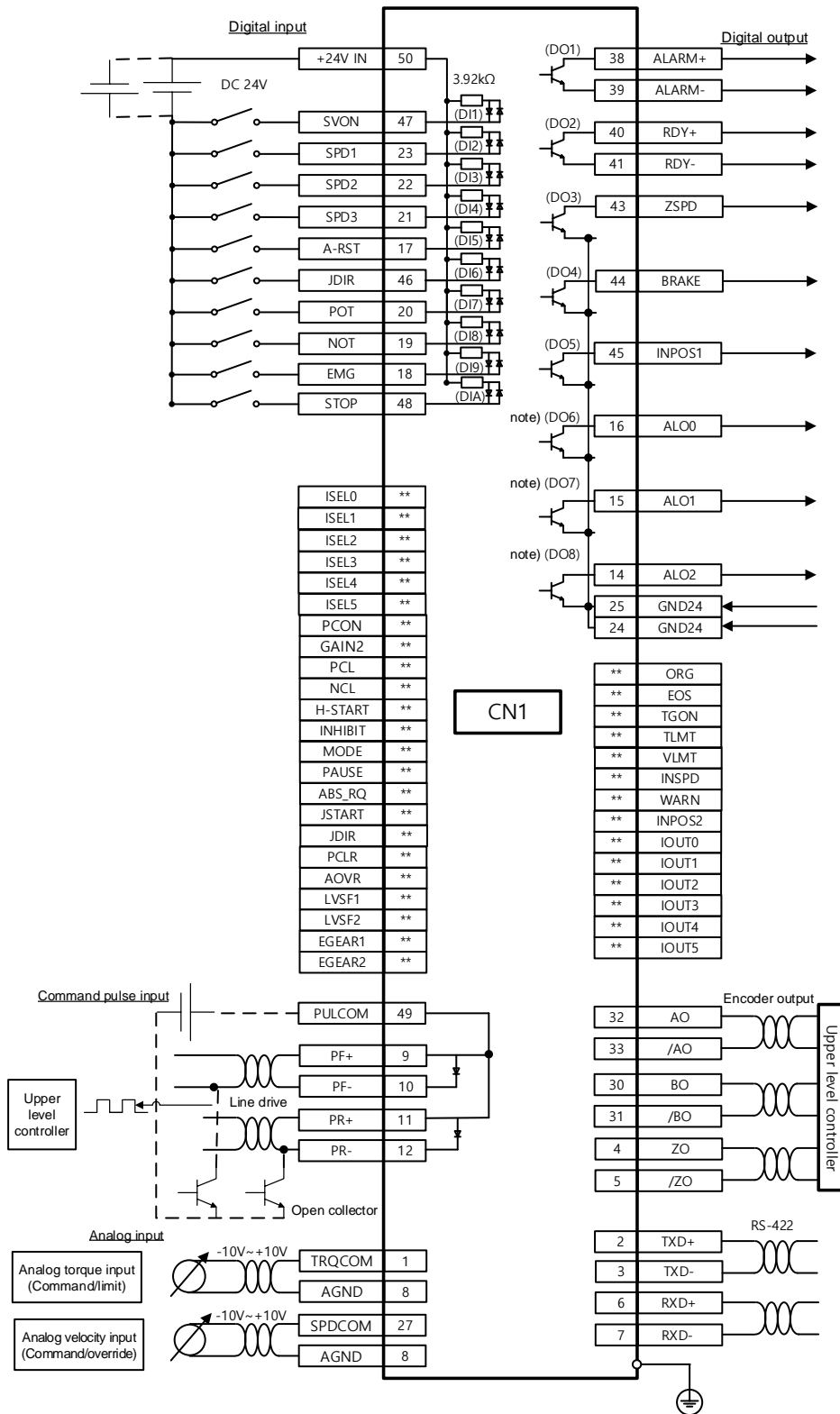

Note 1) Input signals DI1~DI10 and output signals DO1~DO8 are factory default signals. Note before use that DO6~DO8 are locked output ports for which assignment is not possible.

## 3.6 Encoder Signal Panel (Encoder Connector) Wiring

### ■ ENCODER Connector Model: 10114-3000VE (3M)

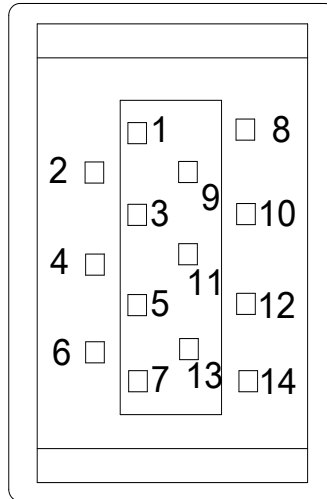

### 3.6.1 Encoder Signal Names by Type

#### ■ Quadrature Type

Pin No.	Signal Names	Pin No.	Signal Names	Pin No.	Signal Names
1	W	6	/U	11	B
2	/W	7	GND	12	/A
3	V	8	/Z	13	A
4	/V	9	Z	14	5V
5	U	10	/B	Frame	SG

#### ■ Serial-Multiturn Type

Pin No.	Signal Names	Pin No.	Signal Names	Pin No.	Signal Names
1	-	6	/SL	11	-
2	-	7	GND	12	-
3	MA	8	-	13	-
4	/MA	9	-	14	5V
5	SL	10	-	Frame	SG

■ APCS-E□□□ES1 Cable(Serial-Multiturn Type)

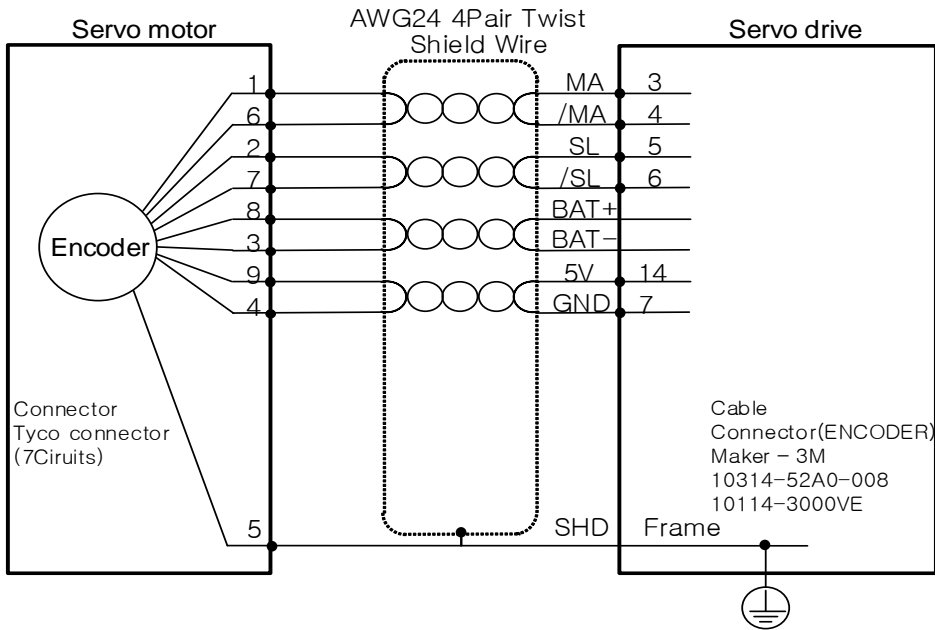

### 3.6.1 Precautions when Making Encoder Cable

If you are using a serial or multi-turn encoder cable that is 20m or longer, our company does not guarantee the quality of use. You are recommended to refer to the following example when making such cables.

Connection example) APCS-E□□□ES cable

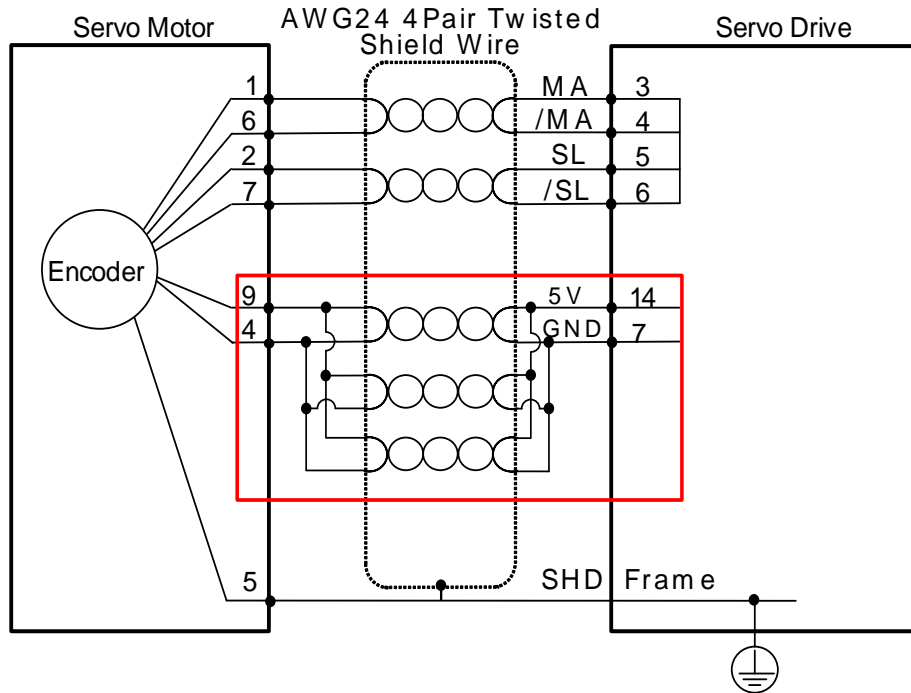

Length	Core wire specifications	Recommended wiring makers	Notes
35m or lower	24AWG 2wire	LS, Ilsan, Shinhwa wires	
55m or lower	24AWG 3wire	LS, Ilsan, Shinhwa wires	

Also, if you are making main power cables for motors 20m or longer, it is recommended to make them to one-level higher specifications than the recommended.

For example, if the recommended specification is 18AWG, use a 14AWG product. If the recommendation is 11AWG, use a 7AWG product.

With main power cables for motors that are 20m or longer, increase in the voltage drop causes the repeated range of use of "rotation torque-torque characteristics" to get narrower. So, be cautious while in use.

## 3.7 Power Connector

### ■ Power Connector Model BCP-508F- 7 GN

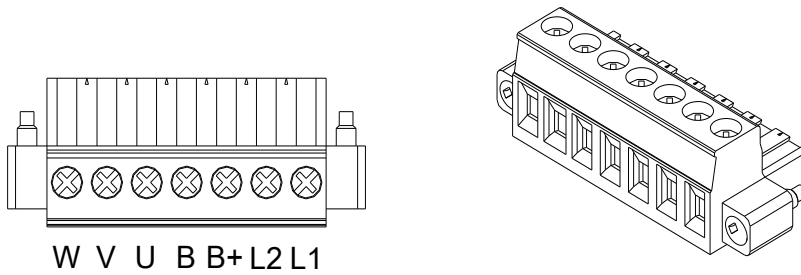

W V U B B+ L2 L1

### ■ Power Connector Signal Names

Signal Names	Description
L1	Main power input part
L2	
B+	Regenerative resistance connection part
B	
U	Motor U, V and W signals connection part
V	
W	



# 4. Operation Modes

## 4.1 Control Method

For position settings, L7C drive supports the indexing position control method which internally generates position commands and the pulse input position control method which receives pulse train inputs from outside. It also supports velocity operation which controls velocity with external analog voltage and internal parameters as well as torque operation which controls torque with external analog voltage.

## 4.2 Indexing Position Operation

Indexing Position Mode is a position control mode which does not use external upper level controllers but generates position profiles inside the drive in order to drive to the target positions. To use the index function, set control mode (0x3000) to "Index Mode 0."

The block diagram of the Indexing Position Mode is as follows.

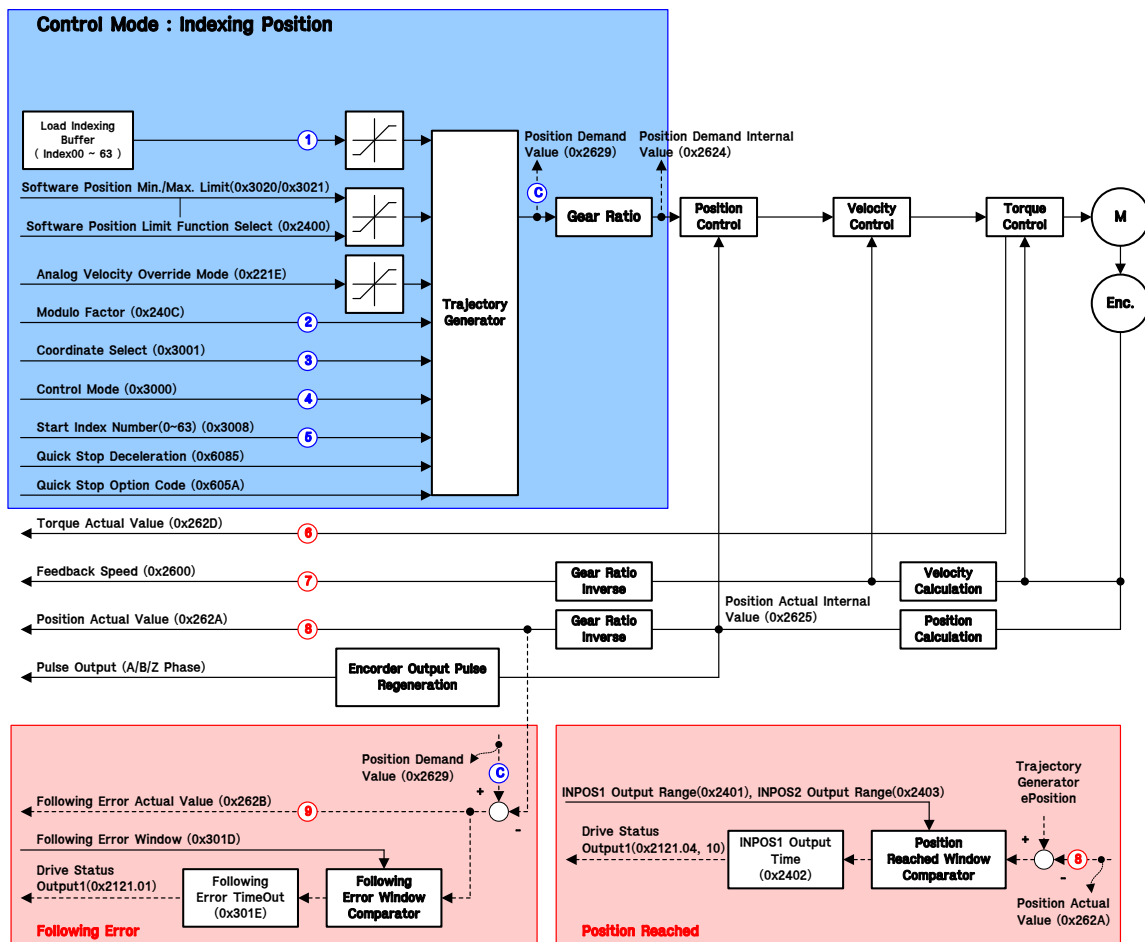

## ■ Related Objects

Index	Sub Index	Name	Variable Type	Accessibility	PDO Assignment	Unit
0x2121	-	Drive Status Output 1	UINT	RO	-	-
0x2122	-	Drive Status Output 2	UINT	RO	-	-
0x220F	-	Analog Velocity Override Mode	UINT	RW	Yes	-
0x2210	-	Analog Torque Input (command/limit) Scale	UINT	RW	Yes	0.1%/V
0x2211	-	Analog Torque Input (command/limit) Offset	INT	RW	Yes	mV
0x2214	-	Analog Velocity Command Scale	INT	RW	Yes	rpm/V
0x2215	-	Analog Velocity Input (command/override)	INT	RW	Yes	mV
0x2629	-	Position Demand Value	DINT	RO	-	UU
0x2624	-	Position Demand Internal Value	DINT	RO	-	pulse
0x2625	-	Position Actual Internal Value	DINT	RO	-	pulse
0x262A	-	Position Actual Value	DINT	RO	-	UU
0x3016	-	Position Limit Function	UINT	RW	-	-
0x3020	-	Software Position Min Limit	DINT	RW	-	-
0x3021	-	Software Position Max Limit	DINT	RW	-	-
0x2600	-	Feedback Velocity	INT	RO	-	rpm
0x262D	-	Torque Actual Value	INT	RO	-	0.1%
0x301D	-	Following Error Window	UDINT	RW	-	UU
0x301E	-	Following Error Timeout	UINT	RW	-	ms
0x2401	-	INPOS1 Output Range	UINT	RW	-	UU
0x2402	-	INPOS1 Output Time	UINT	RW	-	ms
0x2403	-	INPOS2 Output Range	UINT	RW	-	UU
0x300C	-	Electric Gear Numerator 1	UDINT	RW	-	-
0x3010	-	Electric Gear Denominator 1	UDINT	RW	-	-
0x240C	-	Modulo Factor	DINT	RW	-	UU
0x3000	-	Control Mode	UINT	RW	-	-
0x3001	-	Coordinate Select	UINT	RW	-	-
0x3002	-	Baud Rate Select	UINT	RW	-	-

0x3006	-	Encoder Output Pulse	UDINT	RW	-	Pulse
0x3008	-	Start Index Number (0~63)	UINT	RW	-	-
0x3009	-	Index Buffer Mode	UINT	RW	-	-
0x300A	-	IO Signal Configuration	UINT	RW	-	-
0x3100	-	Index 00	-	-	-	-
	0	Number of Entries	USINT	RO	-	-
	1	Index Type	UINT	RW	-	-
	2	Distance	DINT	RW	-	UU
	3	Velocity	DINT	RW	-	UU/s
	4	Acceleration	DINT	RW	-	UU/s <sup>2</sup>
	5	Deceleration	DINT	RW	-	UU/s <sup>2</sup>
	6	Registration Distance	DINT	RW	-	UU
	7	Registration Velocity	DINT	RW	-	UU/s
	8	Repeat Count	UINT	RW	-	-
	9	Dwell Time	UINT	RW	-	ms
	10	Next Index	UINT	RW	-	-
11	Action	UINT	RW	-	-	
~		~				
0x313F	-	Index 63	-	-	-	-

### Internal Block Diagram of Indexing Position Mode

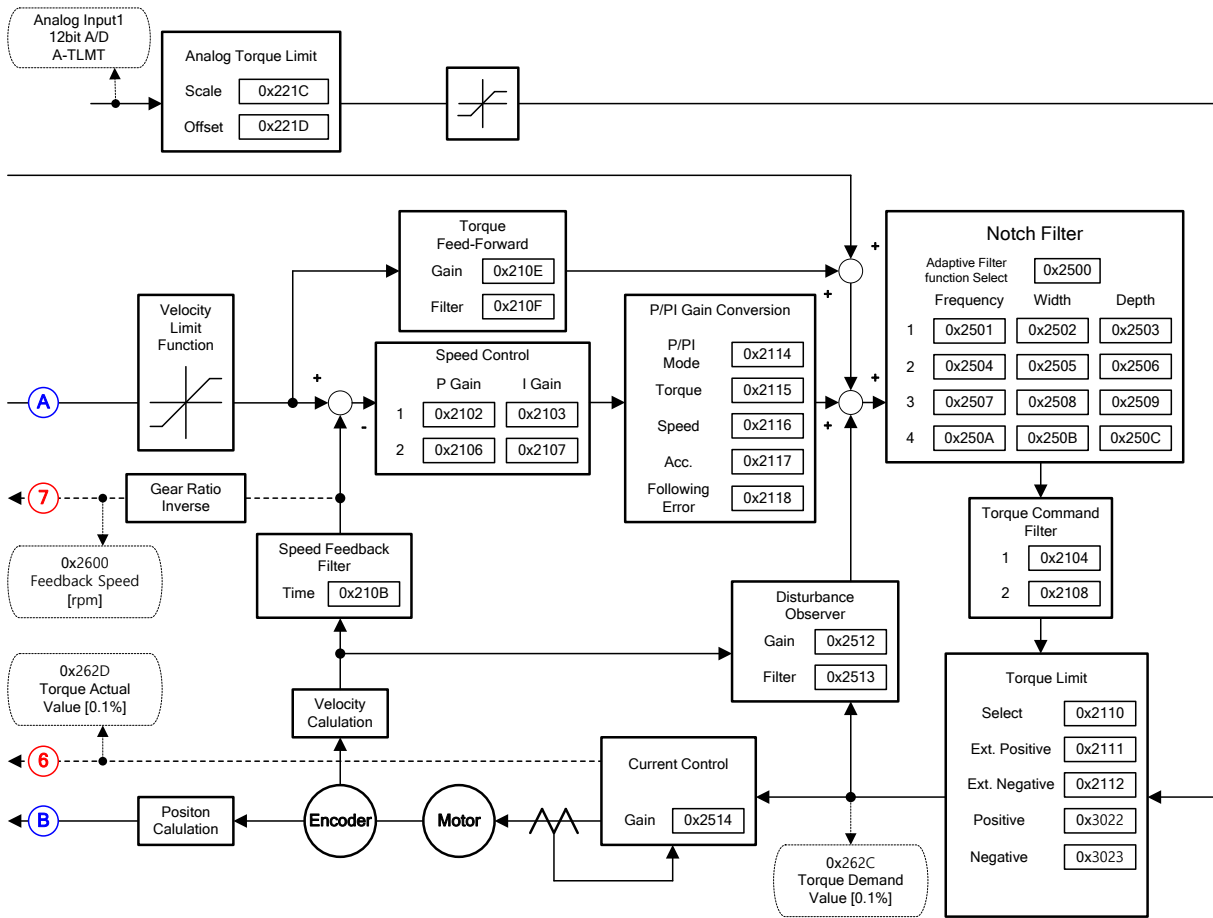

## 4.2.1 Coordinate Settings

In Indexing Mode, the following two coordinate methods are available for use.

### ■ Linear Coordinate Method

In the linear coordinate system, if the value exceeds +2147483647 during forward rotation, the lowest value -2147483648 is displayed. In contrast, if the value goes past -2147483648 in the reverse rotation, the highest value +2147483647 is displayed.

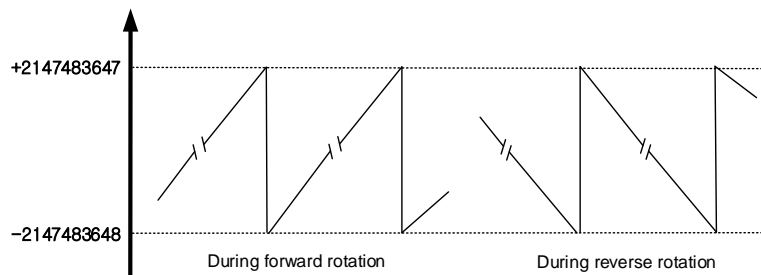

You must set the control mode (0x3000) to the linear coordinate system to enable the below 6 PTP position controls.

- **Absolute Move**  
In Absolute Move, the movement value is determined by the difference between the current position and the target distance values.
- **Relative Move**  
In Relative Move, the movement value equals the target distance value.
- **Registration Absolute Move**  
During movement to the target position, REGT signal input from outside is converted into registration velocity and distance values, and the movement diverts to the new target position (absolute value).
- **Registration Relative Move**  
During movement to the target position, REGT signal input from outside is converted into registration velocity and distance values, and the movement diverts to the new target position (relative value).
- **Blending Absolute Move**  
When a new position command is input during movement to the target position, the current target position is reached and a subsequent movement is made to the new target position (absolute value).
- **Blending Absolute Move**  
When a new position command is input during movement to the target position, the current target position is reached and a subsequent movement is made to the new target position (relative value).

## ■ Rotary Coordinate Method

The rotary coordinate system marks the positions only with positive values. The range of values differ according to the Modulo Factor setting and is displayed in 0~ (Modulo Factor-1).

If the value exceeds (Modulo Factor-1) in the forward rotation, the lowest value 0 is displayed. In contrast, if the value goes past 0 in the reverse rotation, the highest value (Modulo Factor-1) is displayed.

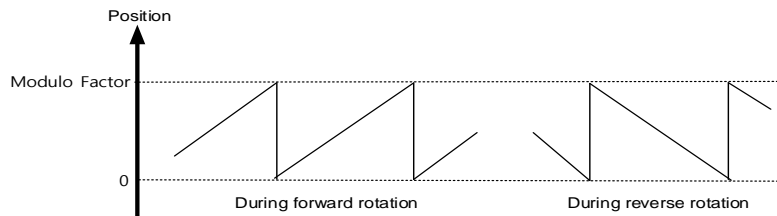

You must set the control mode (0x3000) to the rotary coordinate system to enable the below 5 PTP position controls. Here, the Modulo Factor setting must be proper.

- Rotary Absolute Move

The movement direction is determined according to the relationship between the current position and the distance value for position operation. Movement is not necessarily made by the shortest distance. Rotation is possible only within a revolution (Modulo Factor setting value) according to the distance value.

- Rotary Relative Move

If the distance value is (+), position operation is made in the positive direction, and if the value is (-), in the negative direction. Rotation is possible beyond a revolution (Modulo Factor setting value) according to the distance value.

- Rotary Shortest Move

The shortest distance from the current position determines the direction for position operation. Rotation is possible only within a revolution (Modulo Factor setting value) according to the distance value. The distance value is treated as an absolute value.

- Rotary Positive Move

Position operation is always in the (+) direction. Rotation is possible only within a revolution (Modulo Factor setting value) according to the distance value. The distance value is treated as an absolute value.

- Rotary Negative Move

Position operation is always in the (-) direction. Rotation is possible only within a revolution (Modulo Factor setting value) according to the distance value. The distance value is treated as an absolute value.

## 4.2.2 Index Structure

The index structure consists of the following elements.

Items		Description
Index Type	Linear Coordinate	0: Absolute Move
		1: Relative Move
		2: Registration Absolute Move
		3: Registration Relative Move
		4: Blending Absolute Move
	5: Blending Relative Move	
	Rotary Coordinate	6: Rotary Absolute Move
		7: Rotary Relative Move
		8: Rotary Shortest Move
		9: Rotary Positive Move
10: Rotary Negative Move		
Distance	-2147483648~+2147483647 (Unit: UU*)	
Velocity	1~2147483647 (Unit: UU/s)	
Acceleration	1~2147483647 (Unit: UU/s <sup>2</sup> )	
Deceleration	1~2147483647 (Unit: UU/s <sup>2</sup> )	
Registration Distance	-2147483648~2147483647 (Unit: UU)	
Registration Velocity	1~2147483647 (Unit: UU/s)	
Repeat Count	1~65535	
Dwell Time	0~65535 (Unit: ms)	
Next Index	0~63	
Action	0: Stop 1: Wait for Start 2: Next Index	

\*UU: User Unit

\*For more details on [UU], refer to the User Unit part in “10.3.1 Indexing Position Operation Electric Gear.”

### 4.3 Pulse Input Position Operation

L7C servo drive provides the position determination mode which uses pulse train input from external controllers. To use Pulse Input Position Control Mode, the control mode (0x3000) needs to be set to number 1, "Pulse Input Position Control Mode."

The block diagram of Pulse Input Position Mode is as follows.

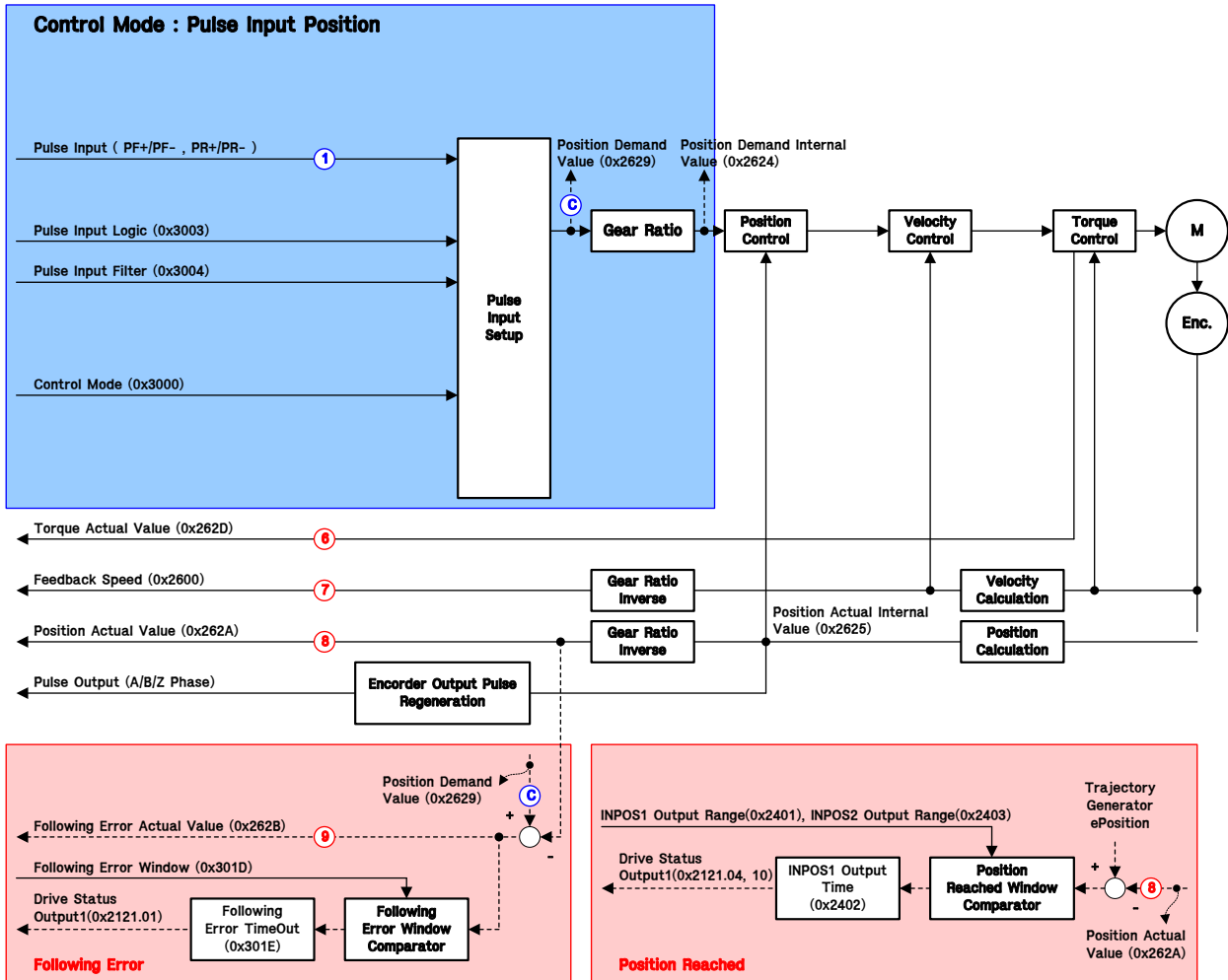



## ■ Related Objects

Index	Sub Index	Name	Variable Type	Accessibility	PDO Assignment	Unit
0x2121	-	Drive Status Output 1	UINT	RO	Yes	-
0x2122	-	Drive Status Output 2	UINT	RO	Yes	-
0x2210	-	Analog Torque Input (command/limit) Scale	UINT	RW	Yes	0.1%/V
0x2211	-	Analog Torque Input (command/limit) Offset	INT	RW	Yes	mV
0x2629	-	Position Demand Value	DINT	RO	Yes	UU
0x2624	-	Position Demand Internal Value	DINT	RO	Yes	pulse
0x2625	-	Position Actual Internal Value	DINT	RO	Yes	pulse
0x262A	-	Position Actual Value	DINT	RO	Yes	UU
0x2600	-	Feedback Velocity	DINT	RO	Yes	rpm
0x262D	-	Torque Actual Value	INT	RO	Yes	0.1%
0x301D	-	Following Error Window	UDINT	RW	No	UU
0x301E	-	Following Error Timeout	UINT	RW	No	ms
0x2401	-	INPOS1 Output Range	UINT	RW	-	UU
0x2402	-	INPOS1 Output Time	UINT	RW	-	ms
0x2403		INPOS2 Output Range	UINT	RW	-	UU
0x300C	-	Electric Gear Numerator 1	UDINT	RW	No	-
0x300D	-	Electric Gear Numerator 2	UDINT	RW	No	-
0x300E	-	Electric Gear Numerator 3	UDINT	RW	No	-
0x300F	-	Electric Gear Numerator 4	UDINT	RW	No	-
0x3010	-	Electric Gear Denominator 1	UDINT	RW	No	-
0x3011	-	Electric Gear Denominator 2	UDINT	RW	No	-
0x3012	-	Electric Gear Denominator 3	UDINT	RW	No	-
0x3013	-	Electric Gear Denominator 4	UDINT	RW	No	-
0x3000	-	Control Mode	UINT	RW	No	-
0x3001	-	Coordinate Select	UINT	RW	No	-
0x3002	-	Baud Rate Select	UINT	RW	No	-
0x3003	-	Pulse Input Logic Select	UINT	RW	No	-
0x3004	-	Pulse Input Filter Select	UINT	RW	No	-
0x3005	-	PCLEAR Mode Select	UINT	RW	No	-

0x3006	-	Encoder Output Pulse	UDINT	RW	No	Pulse
-	-	-	-	-	-	-

### Internal Block Diagram of Pulse Input Position Mode

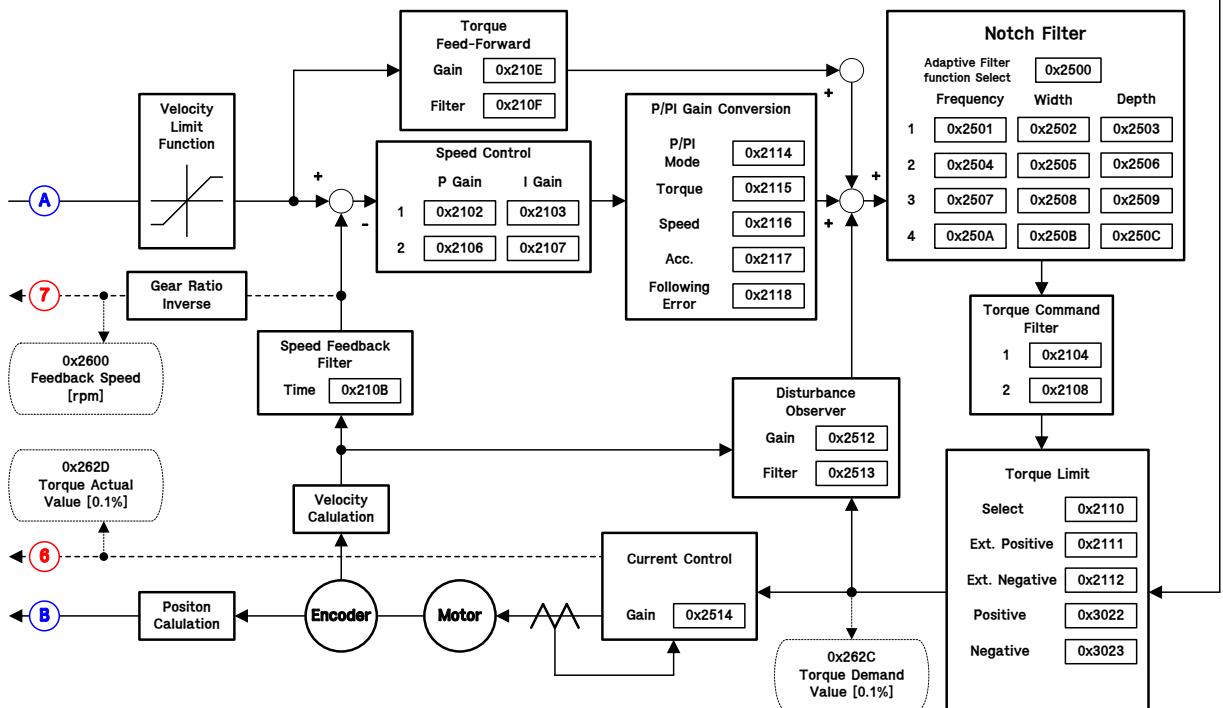
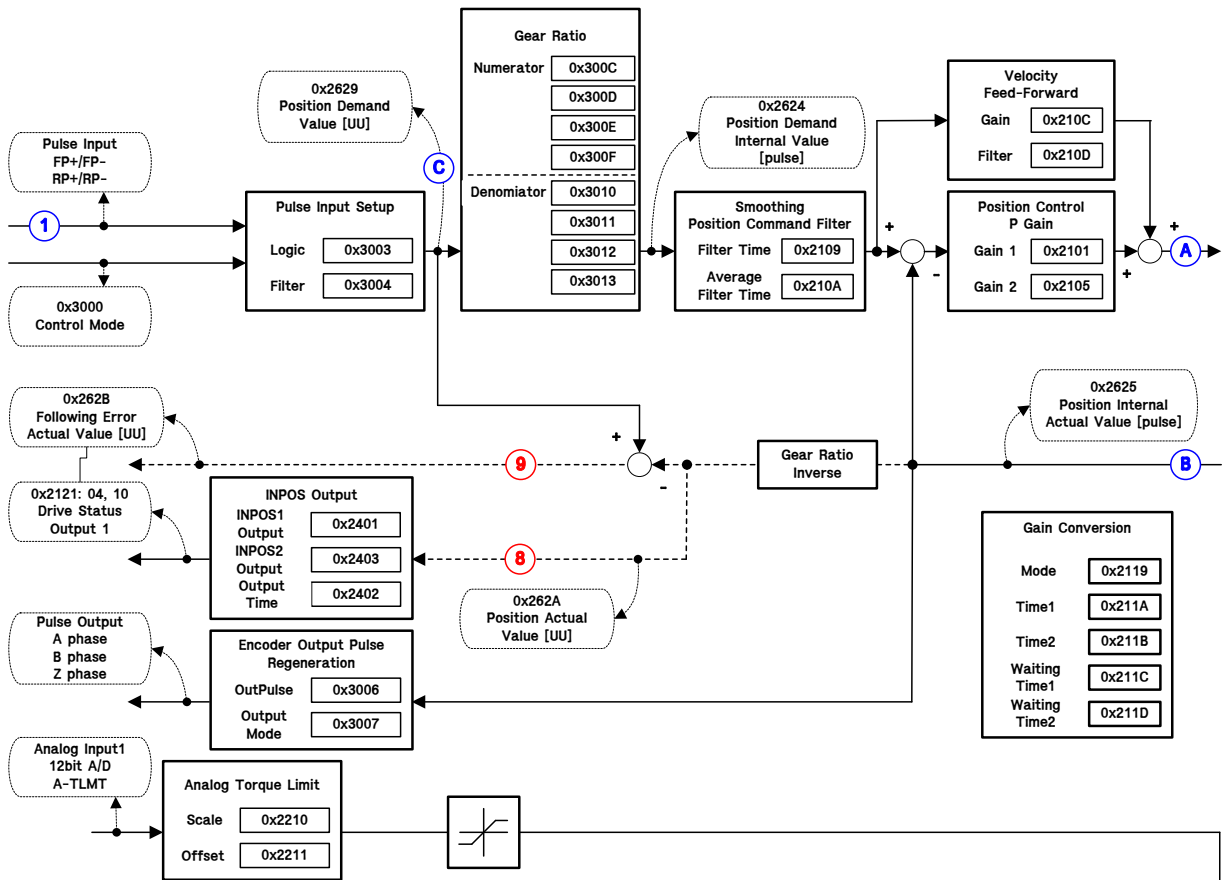

## 4.4 Velocity Mode

Velocity Mode is used to control velocity by issuing velocity commands to the servo drive in the form of analog voltage output from the upper level controller and digital inputs which use parameter setting values inside the servo drive.

Set the control mode [0x3000] to 2 and select the velocity command switch select [0x231A] according to the method of command to the servo drive.

The block diagram of Velocity Mode is as follows.

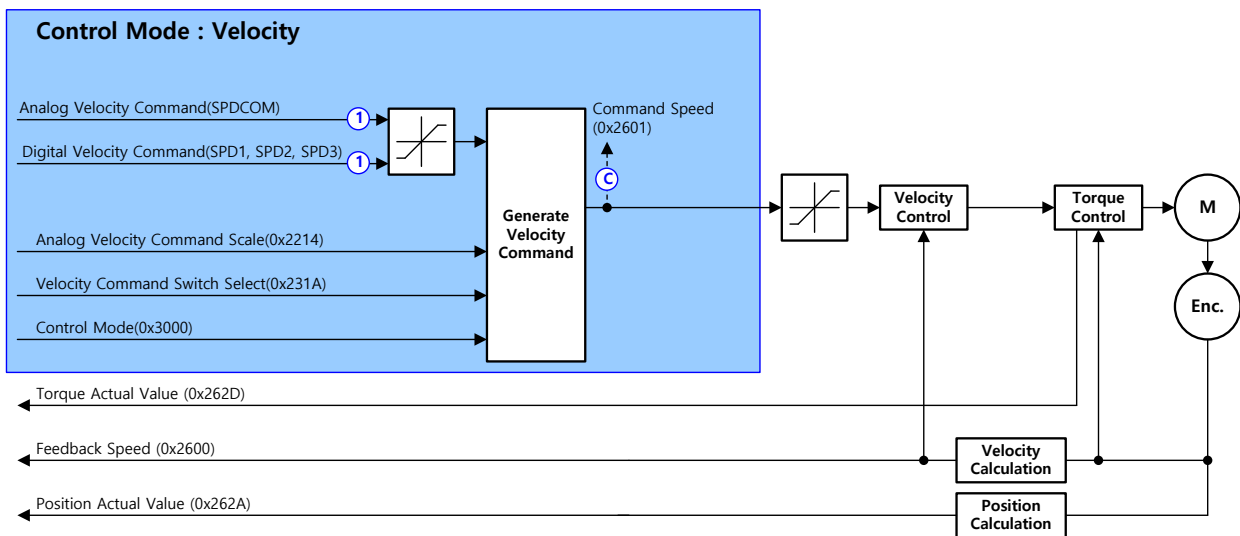

## ■ Related Objects

Index	Sub Index	Names	Variable Type	Accessibility	PDO Assignment	Unit
0x2121	-	Drive Status Output 1	UINT	RO	Yes	-
0x2122	-	Drive Status Output 2	UINT	RO	Yes	-
0x2629	-	Position Demand Value	DINT	RO	Yes	UU
0x2624	-	Position Demand Internal Value	DINT	RO	Yes	pulse
0x2625	-	Position Actual Internal Value	DINT	RO	Yes	pulse
0x262A	-	Position Actual Value	DINT	RO	Yes	UU
0x2600	-	Feedback Velocity	INT	RO	No	rpm
0x262D	-	Torque Actual Value	INT	RO	Yes	0.1%
0x301D	-	Following Error Window	UDINT	RW	No	UU
0x301E	-	Following Error Timeout	UINT	RW	No	ms
0x2401	-	INPOS1 Output Range	UINT	RW	-	UU
0x2402	-	INPOS1 Output Time	UINT	RW	-	ms
0x2403	-	INPOS2 Output Range	UINT	RW	-	UU
0x3000	-	Control Mode	UINT	RW	No	-
0x3002	-	Baud Rate Select	UINT	RW	No	-
0x3006	-	Encoder Output Pulse	UDINT	RW	No	Pulse
-	-	-	-	-	-	-
0x2200	-	Digital Input Signal 1 Selection	UINT	RW	No	-
0x2201	-	Digital Input Signal 2 Selection	UINT	RW	No	-
0x2202	-	Digital Input Signal 3 Selection	UINT	RW	No	-
0x2203	-	Digital Input Signal 4 Selection	UINT	RW	No	-
0x2204	-	Digital Input Signal 5 Selection	UINT	RW	No	-
0x2205	-	Digital Input Signal 6 Selection	UINT	RW	No	-
0x2206	-	Digital Input Signal 7 Selection	UINT	RW	No	-
0x2207	-	Digital Input Signal 8 Selection	UINT	RW	No	-
0x2208	-	Digital Input Signal 9 Selection	UINT	RW	No	-
0x2209	-	Digital Input Signal 10 Selection	UINT	RW	No	-
-	-	-	-	-	-	-

0x2214	-	Analog Velocity Input (command/limit) Scale	UINT	RW	Yes	rpm/V
0x2215	-	Analog Velocity Input (command/limit) Offset	INT	RW	Yes	mV
0x2216	-	Analog Velocity Command Clamp Level	UINT	RW	No	-
0x2217	-	Analog Velocity Command Filter Time Constant	UINT	RW	No	0.1ms
0x2229	-	Analog Velocity Command Scale	INT	RW	No	-
0x2312	-	Multi-Step Operation Velocity 1	INT	RW	No	-
0x2313	-	Multi-Step Operation Velocity 2	INT	RW	No	-
0x2314	-	Multi-Step Operation Velocity 3	INT	RW	No	-
0x2315	-	Multi-Step Operation Velocity 4	INT	RW	No	-
0x2316	-	Multi-Step Operation Velocity 5	INT	RW	No	-
0x2317	-	Multi-Step Operation Velocity 6	INT	RW	No	-
0x2318	-	Multi-Step Operation Velocity 7	INT	RW	No	-
0x2319	-	Multi-Step Operation Velocity 8	INT	RW	No	-
0x231A	-	Velocity Command Switch Select	UINT	RW	No	-

### Internal Block Diagram of Velocity Mode

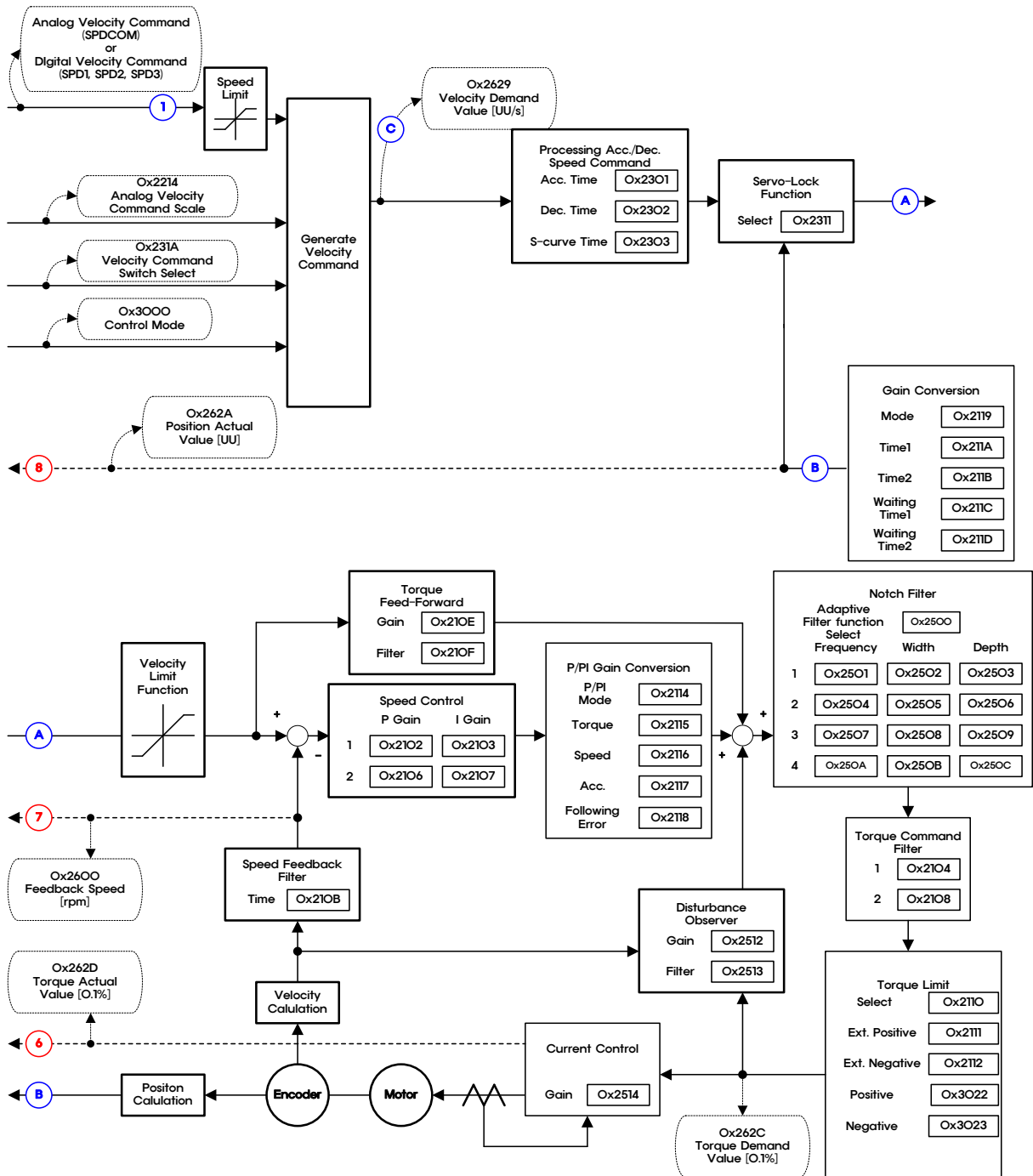

## 4.5 Torque Operation

Torque Mode is used to control tension or pressure of the device's mechanical parts by the means of the servo drive receiving from the upper level controller the voltage inputs for the desired torques.

Set the control mode [0x3000] to 3.

To input commands, apply voltage of -10[V]~+10[V] to pin number 1 and 8 of the CN1 connector.

The block diagram of Torque Mode is as follows.

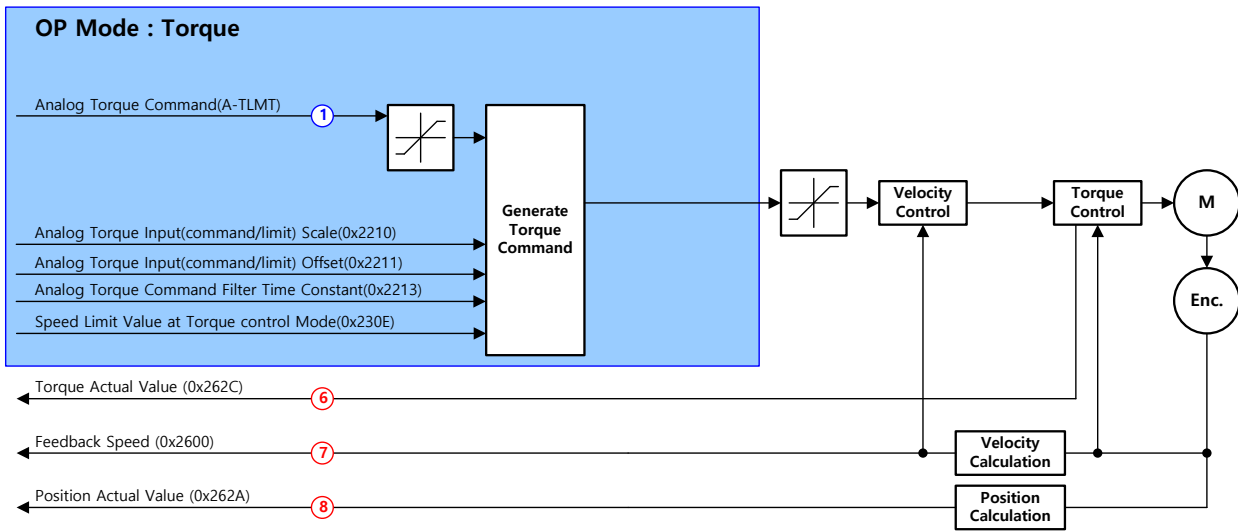

### ■ Related Objects

Index	Sub Index	Name	Variable Type	Accessibility	PDO Assignment	Unit
0x2121	-	Drive Status Output 1	UINT	RO	Yes	-
0x2122	-	Drive Status Output 2	UINT	RO	Yes	-
0x2629	-	Position Demand Value	DINT	RO	Yes	UU
0x2624	-	Position Demand Internal Value	DINT	RO	Yes	pulse
0x2625	-	Position Actual Internal Value	DINT	RO	Yes	pulse
0x262A	-	Position Actual Value	DINT	RO	Yes	UU
0x2600	-	Feedback Velocity	INT	RO	Yes	rpm
0x262D	-	Torque Actual Value	INT	RO	Yes	0.1%
0x301D	-	Following Error Window	UDINT	RW	No	UU
0x301E	-	Following Error Timeout	UINT	RW	No	ms
0x2401	-	INPOS1 Output Range	UINT	RW	-	UU
0x2402	-	INPOS1 Output Time	UINT	RW	-	ms



0x2403		INPOS2 Output Range	UINT	RW	-	UU
0x3000	-	Control Mode	UINT	RW	No	-
0x3002	-	Baud Rate Select	UINT	RW	No	-
0x3006	-	Encoder Output Pulse	UDINT	RW	No	Pulse
0x2210	-	Analog Torque Input (command/limit) Scale	UINT	RW	No	0.1%/V
0x2211	-	Analog Torque Input (command/limit) Offset	INT	RW	No	mV
0x2212	-	Analog Torque Command Clamp Level	UINT	RW	No	rpm
0x2213	-	Analog Torque Command Filter Time Constant	UINT	RW	No	0.1ms
0x230E	-	Velocity Limit Value at Torque Control Mode	UINT	RW	No	-

### Internal Block Diagram of Velocity Mode

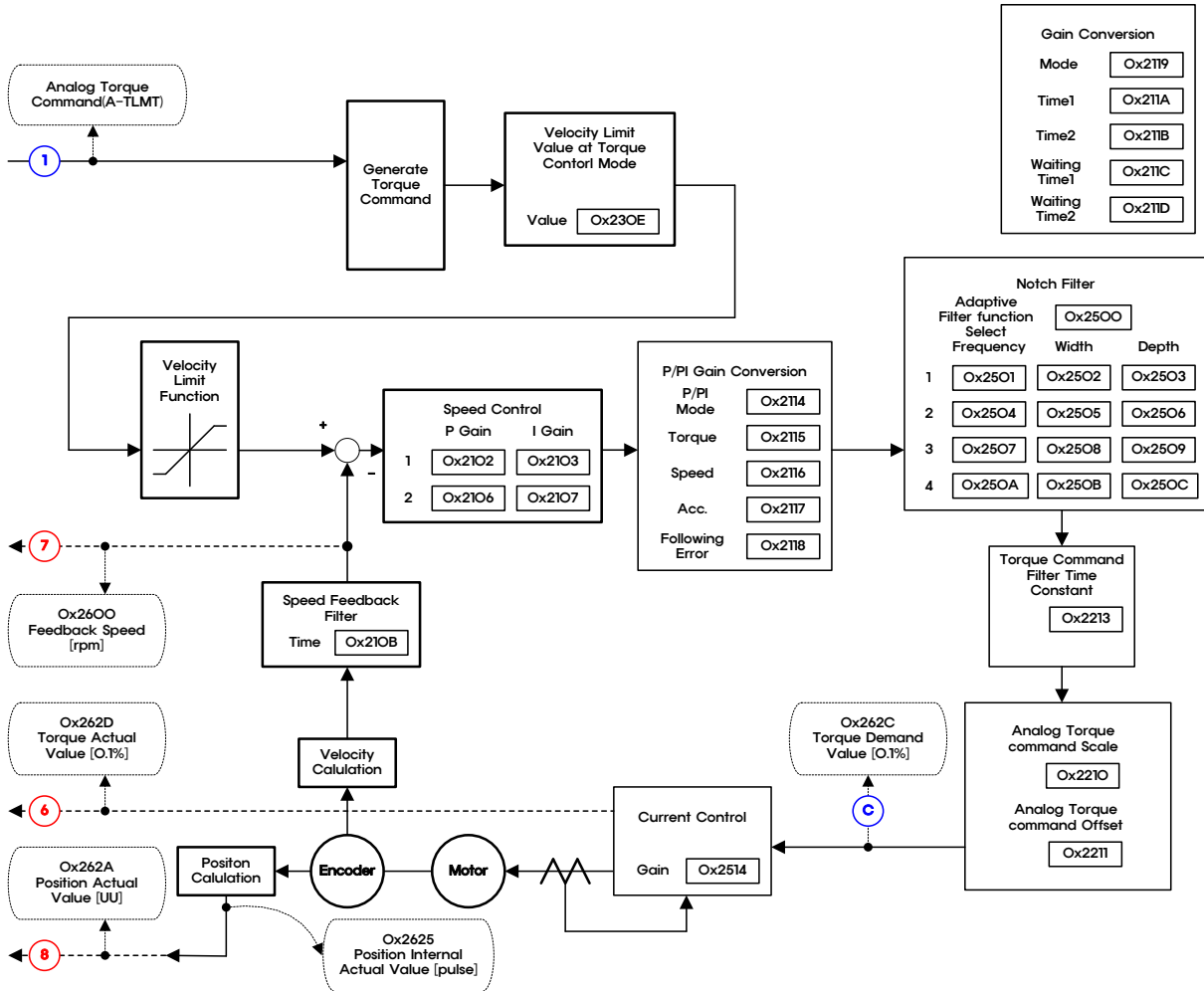

## 5. Indexing Position Operation

### 5.1 Concept of Index

A single index consists of Distance, Velocity, Acceleration, Deceleration, Registration Distance, Registration Velocity, Repeat Count, Dwell Time, Next Index, and Action. Below are details of each of these elements.

#### ■ Distance

Distance refers to the movement distance of each index (Unit: UU), which can be set to either an absolute or relative value.

In Absolute Move, the final movement value is determined by the difference between the current position and the target distance values. In Relative Move, the final movement value equals the target distance value.

In a velocity/acceleration pattern as the one below, the final movement value equals the total area.

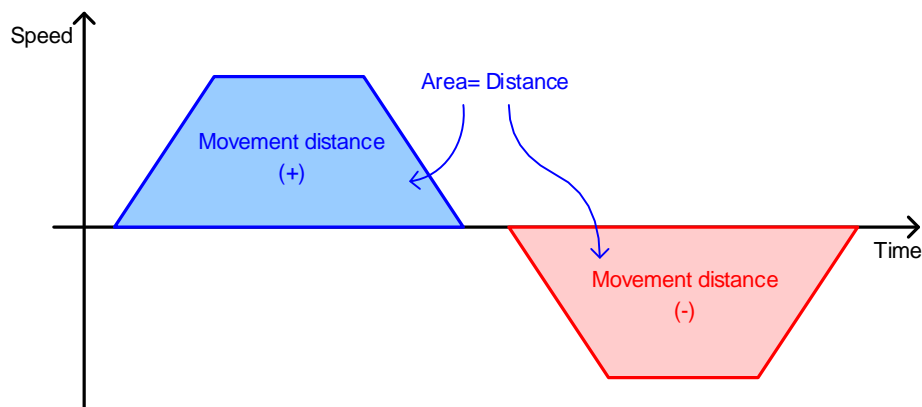

### ■ Velocity

You can set the target velocity (Unit: UU/s) of index operation.

Velocity is set to a positive (+) value regardless of Distance, and the sign of the target velocity is determined by the sign of Distance.

If the Distance value is not enough when compared to Velocity or Acceleration, a triangular pattern could be formed in which the index cannot reach the target velocity.

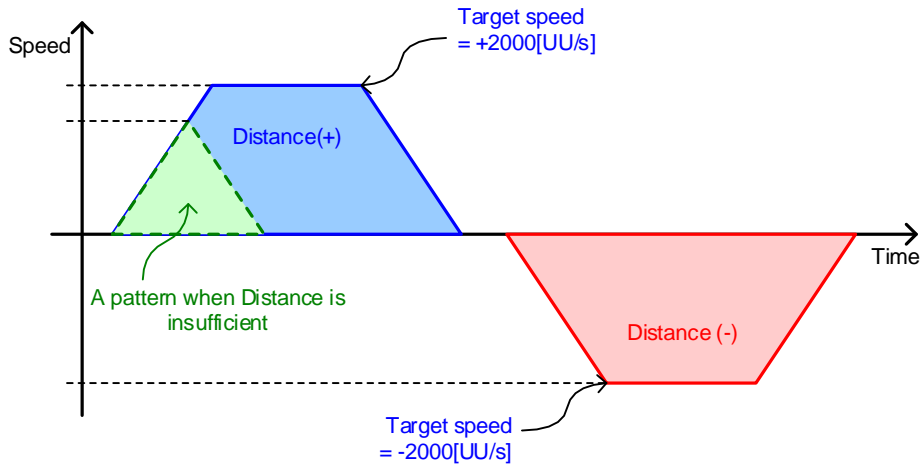

### ■ Acceleration and Deceleration

You can set Acceleration and Deceleration for index operation. The device supports an asymmetrical Acceleration/Deceleration operation, in which Acceleration and Deceleration are set to different values.

In the below figure, when the settings are Velocity = 1000 [UU/s], Acceleration = 10000 [UU/s<sup>2</sup>], and Deceleration = 20000 [UU/s<sup>2</sup>], Acceleration time period and Deceleration time period needed to reach the target velocities are 100 [ms] = (1000 [UU/s] / 10000 [UU/s<sup>2</sup>]), 50[ms] = (1000 [UU/s] / 20000 [UU/s<sup>2</sup>]), respectively.

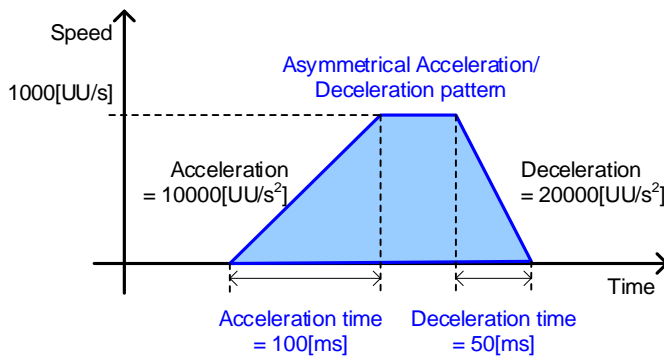

## ■ Registration Distance and Registration Velocity

When the index type is Registration Absolute or Registration Relative, you can change operation velocity and movement distance according to REGT signal input from the outside.

Movement distance after REGT signal input is determined by Registration Distance.

Below are the definitions of Registration Distance and Registration Velocity.

- Registration Distance  
Movement distance after REGT signal input from outside (Unit: UU)
- Registration Velocity  
Target velocity after REGT signal input from outside (Unit: UU/s)

Acceleration and Deceleration during a velocity change in registration follow the previously set values.

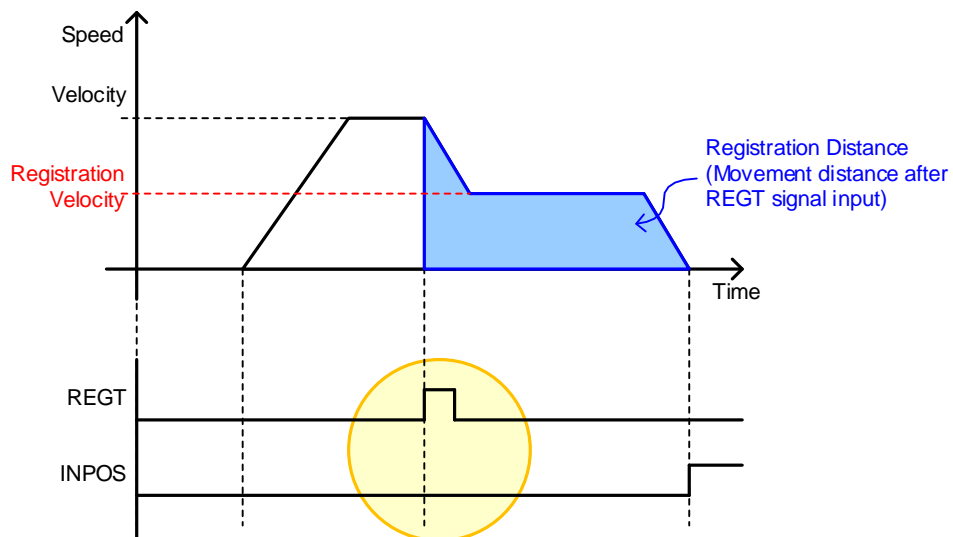

■ Repeat Count

The index operates repeatedly as many times as set for the Repeat Count value.

The setting value in Dwell Time is applied during a repeated operation of an index.

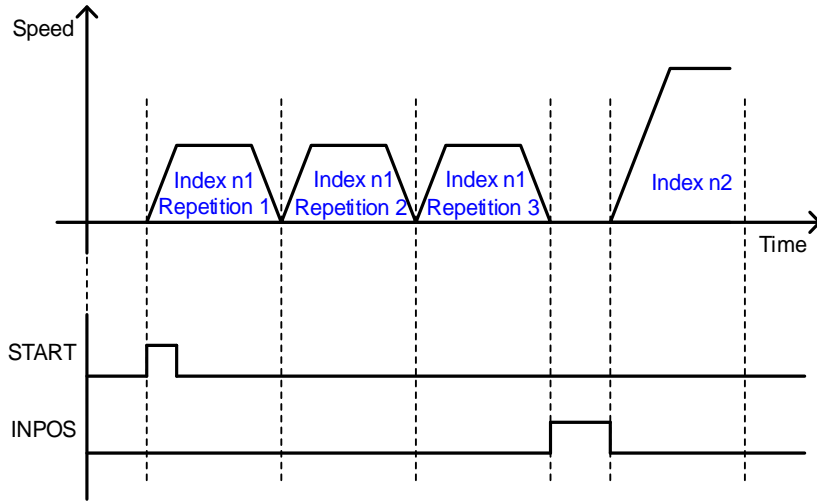

■ Dwell Time

You can set the waiting time period between index operations (Unit: ms).

The set Dwell Time is applied after generation of the index operation pattern is completed as shown in the example in the figure below.

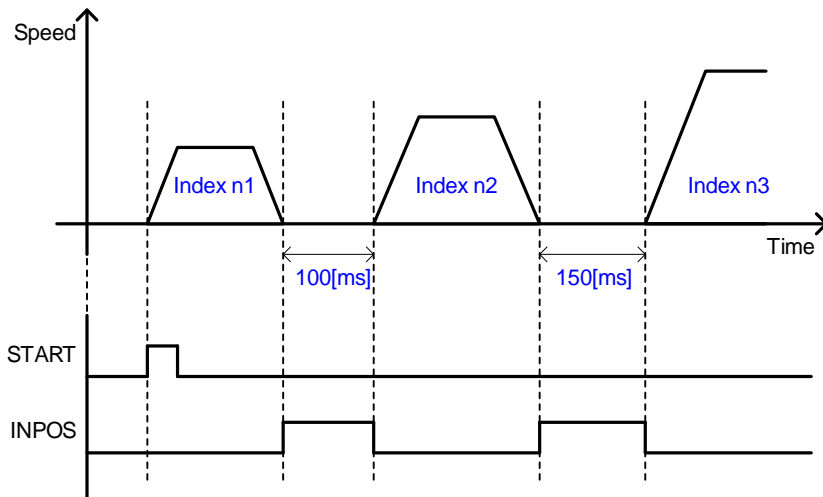

## ■ Next Index

When Action of the index is set to Next Index (setting value 2), you can set the number of the index to be automatically run after the end of the current index operation.

For details, refer to the description of Next Index for Action.

## ■ Action

In the Indexing Position Mode, you can use the following 3 methods according to the index operation Action.

- STOP

When Action of the index is set to Stop (Setting Value 0), the entire sequence ends after the end of the current index's operation.

When START signal is input from outside, Indexing Position operation starts from the index (0~63) set in Start Index (0x3008).

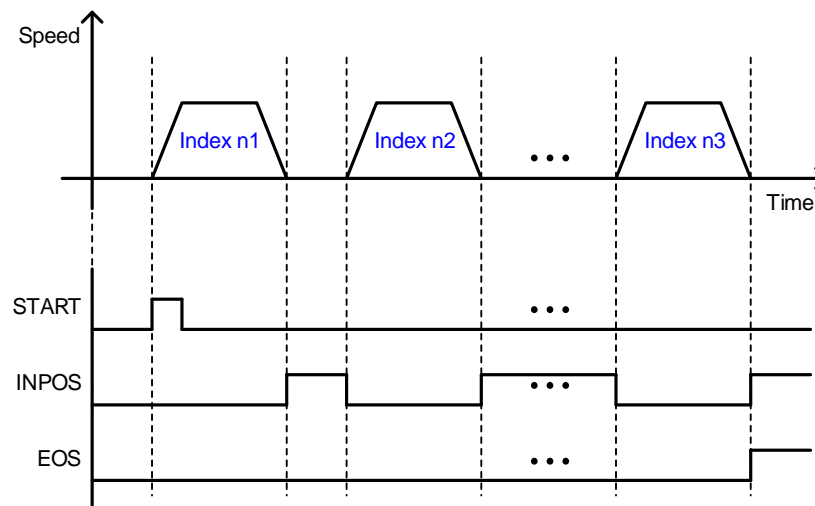

- Wait for Start

When Action of the index is set to Wait for Start (Setting Value 1), the index after the current one follows START signal input and starts to operate when the current index operation ends.

The index that operates when START signal is input is determined by ISEL0~5 (Index Select) signal. Here, the value set in Next Index is irrelevant.

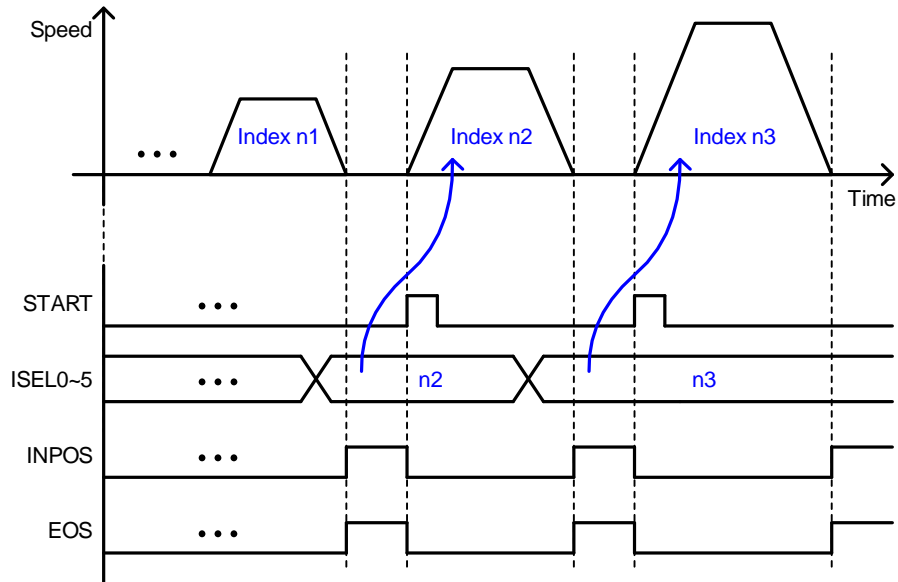

- Next Index

When Action of the index is set to Next Index (Setting Value 2), the index set in Next Index automatically operates after the end of the current index operation.

Operation can start automatically with the previously input index even if the digital input signal (START, ISEL0~5) is not entered.

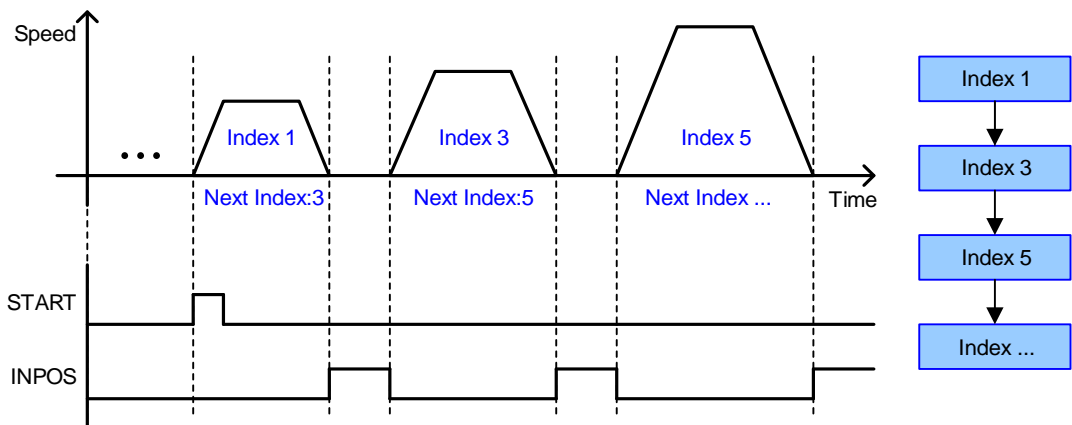



- Action setting example

With a combination of Wait for Start and Next Index settings, the sectioned sequence shown in the below figure can be structured.

Here, Action of Index 3 must be set to Wait for Start.

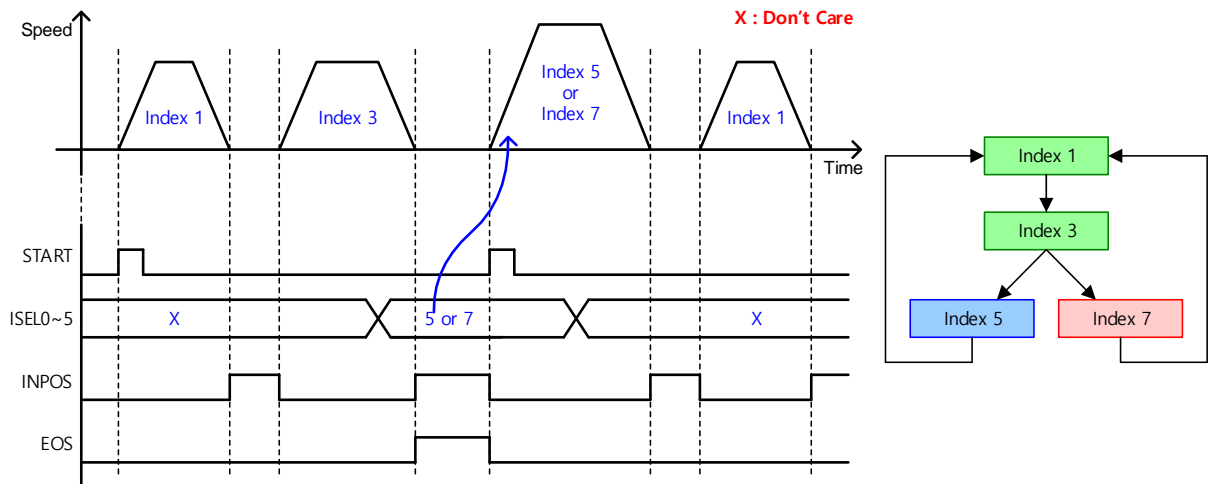

## 5.2 Index Type

L7C drive supports 11 Index Types in total, which are described below.

### 5.2.1 Absolute/Relative Move

These are the most basic PTP (Point-to-Point) operation methods in which an absolute or relative movement is made according to the set velocity and acceleration values.

#### ■ Absolute Move

The movement distance is determined by subtracting the current position value from the input Distance value. (=Distance - Current Position)

ex) Absolute Move is performed with current position value = 500 and Distance = 1000

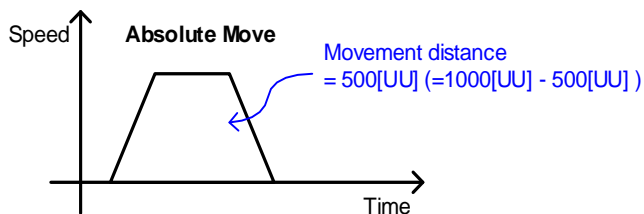

#### ■ Relative Move

The movement distance equals the Distance value.

ex) Relative Move is performed with current position value = 500 and Distance = 1000

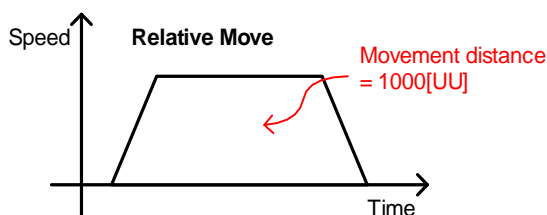

## 5.2.2 Registration Absolute/Relative Move

You can change the operation velocity and target distance according to the REGT signal input from outside.

This is a similar function to motion pattern generation in VP-3 (positioning after feeder and sensor operation), a past drive model of the company.

### ■ Registration Absolute Move

Absolute Move is run with the value set for Distance. It operates with Distance and Velocity values in Registration Distance/Velocity set after REGT signal input during movement. Movement distance after REGT signal input is determined by the value set in Registration Distance.

### ■ Registration Relative Move

Relative Move is run with the value set for Distance. It operates with Distance and Velocity values in Registration Distance/Velocity set after REGT signal input during movement. Movement distance after REGT signal input is determined by the value set in Registration Distance.

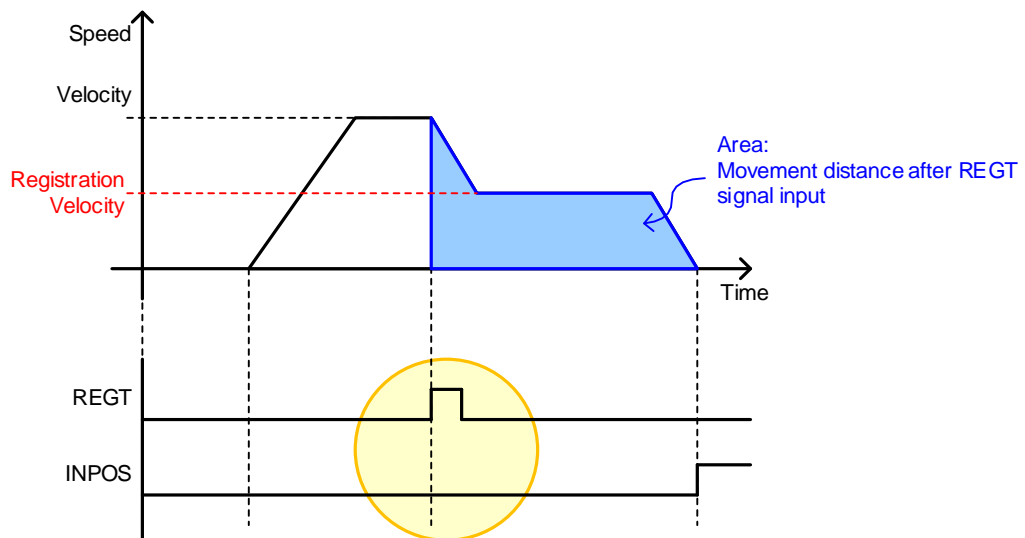

## 5.2.3 Blending Absolute/Relative Move

This is an operation method which uses a single operation pattern which combines consecutive indexes.

Each index does not stop to 0 velocity at its end, and the operation is passed on to the next index.

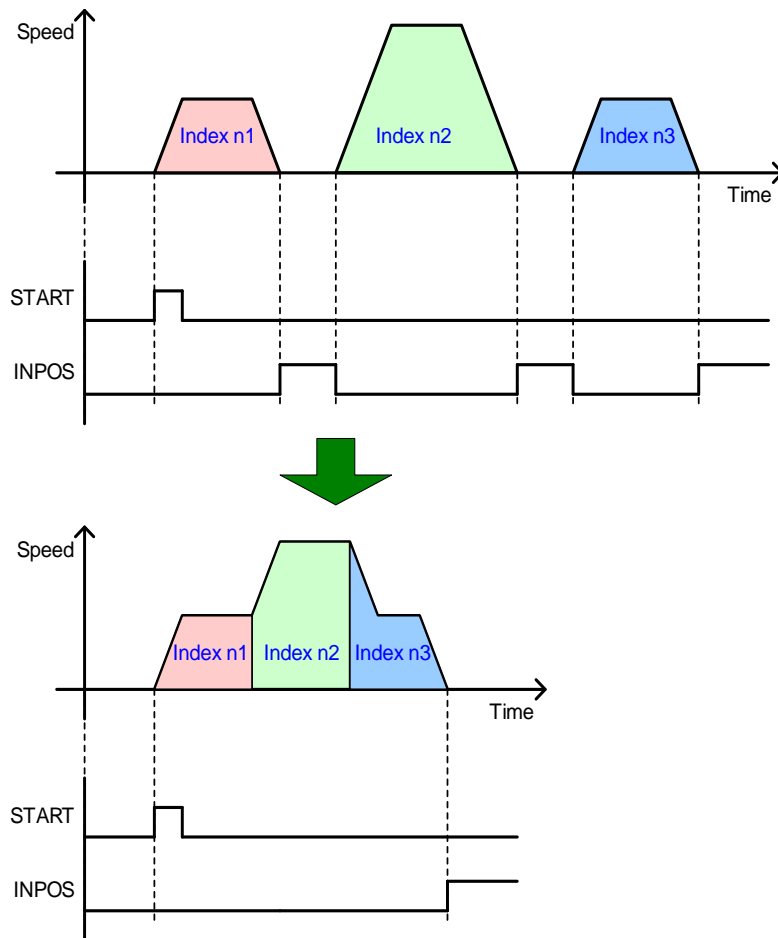

## 5.2.4 Rotary Absolute/Relative Move

### ■ Rotary Absolute Move

This function is available only when the coordinate system is set to the rotary method.

The direction of rotation is determined by the relationship between the starting position and the command position. If the starting position value is smaller than the command position value, the rotation runs in the forward direction, and for the opposite case, it runs in the reverse direction. Here, the movement is not necessarily made by the shortest distance.

You can input a value greater than a revolution (Value set in Modulo Factor: 0x240C) or a negative value (-90° equals 270° when Modulo Factor is 360°). In this case, the final position is set in consideration of Modulo Factor. Putting in a negative value in such a case is useful because the index can pass the 0 point in its reverse rotation.

Depending on the command value, rotation can exceed a revolution.

The following figure shows an example of a forward rotation from 30° to 240° and a reverse rotation from 300° to 240°.

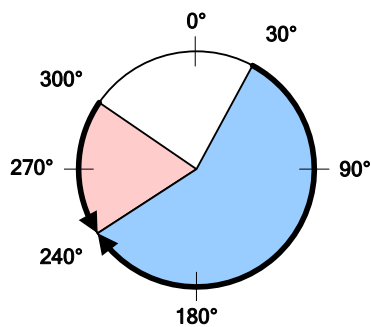

## ■ Rotary Relative Move

This function is available only when the coordinate system is set to the rotary method.

If the command Distance value is positive (+), the index moves in the positive direction, and if the value is negative (-), it moves in the negative direction. You can input a value greater than a revolution (Value set in Modulo Factor: 0x240C) and rotation can exceed a revolution depending on the command value.

The following figure shows an example of a  $+180^\circ$  movement from  $30^\circ$  to  $210^\circ$  and a  $-120^\circ$  movement from  $30^\circ$  to  $-90^\circ$ .

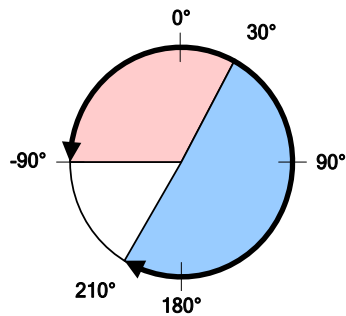

## 5.2.5 Rotary Shortest Move

This function is available only when the coordinate system is set to the rotary method.

The shorter of the forward and reverse directions becomes the movement direction.

Rotation runs only within a revolution (Value set in Modulo Factor: 0x240C). The Distance value is treated as an absolute value.

The following figure shows an example of movements in the shorter direction in a reverse rotation from  $30^\circ$  to  $310^\circ$  and in a forward rotation from  $30^\circ$  to  $180^\circ$ .

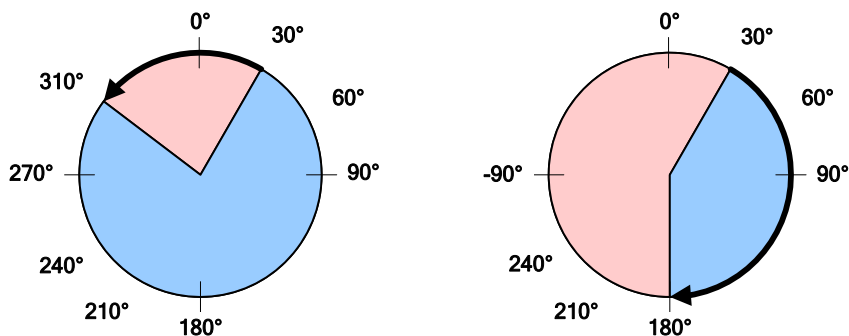

## 5.2.6 Rotary Positive/Negative Move

### ■ Rotary Positive Move

This function is available only when the coordinate system is set to the rotary method.

The index always moves in the positive (+) direction regardless of the starting position and command position (Distance).

Rotation runs only within a revolution (Value set in Modulo Factor: 0x240C). The Distance value is treated as an absolute value.

The following figure shows an example of movements in the forward rotation from 300° to 30° and from 30° to 180°.

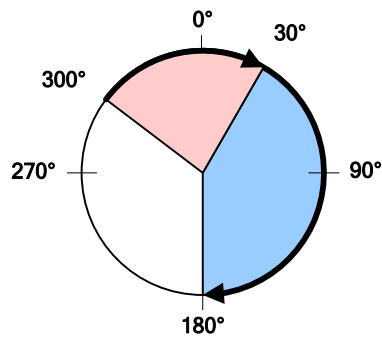

### ■ Rotary Negative Move

This function is available only when the coordinate system is set to the rotary method.

The index always moves in the negative (-) direction regardless of the starting position and command position (Distance).

Rotation runs only within a revolution (Value set in Modulo Factor: 0x240C). The Distance value is treated as an absolute value.

The following figure shows an example of reverse rotation from 60° to 340° and from 340° to 180°.

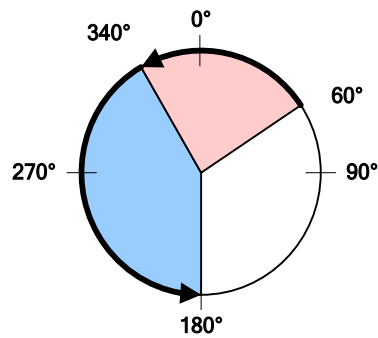



## 5.3 Function of Index Input Signal

### ■ PAUSE

PAUSE (Rising edge) input during index operation temporarily stops current index operation.

Another input of PAUSE (Rising edge) performs movement of the remaining distance.

The INPOS signal is output when the value of Following Error is lower than that of Following Error Window [0x301D].

The EOS signal is output when movement for the remaining index distance is completed after PAUSE is re-input.

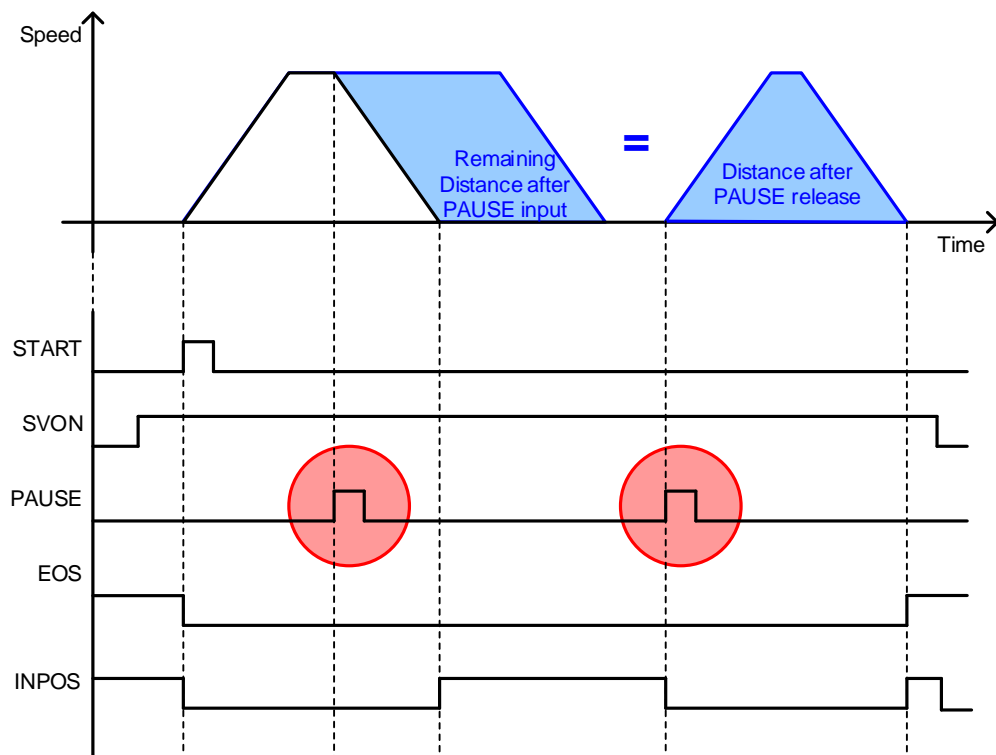

## ■ STOP

STOP (Rising edge) input stops the movement using the stop deceleration (0x6085) and terminates the index operation sequence.

Input of the START signal resumes the operation from the index set in Start Index (0x3008).

However, if Start Index (0x3008) is set to 64, Start Index is set to the value at ISEL0~5.

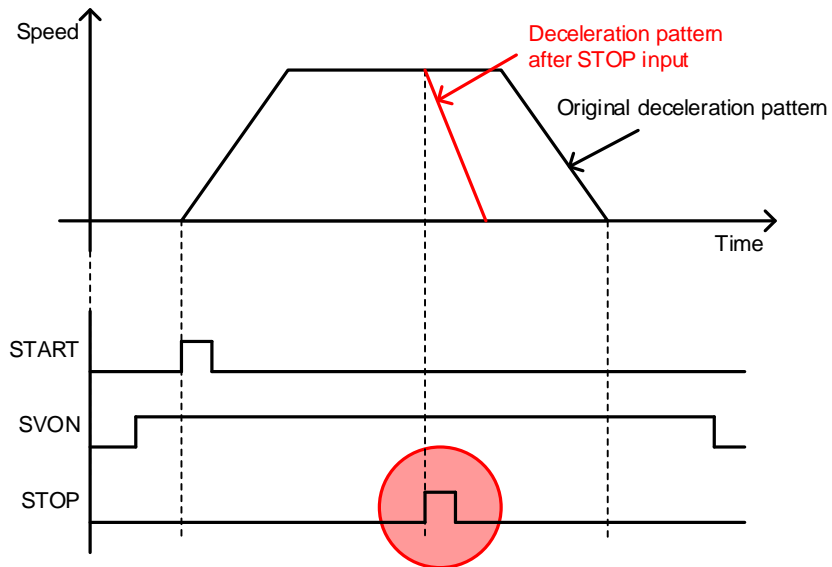

## ■ HSTART (Homing Start), ORG (Completion signal of homing operation)

HSTART (Rising edge) input activates homing. Any HSTART input signal during homing is ignored.

When the homing is completed, the ORG (Origin: homing complete) signal is output. When homing is initiated, the ORG signal is reset to 0.

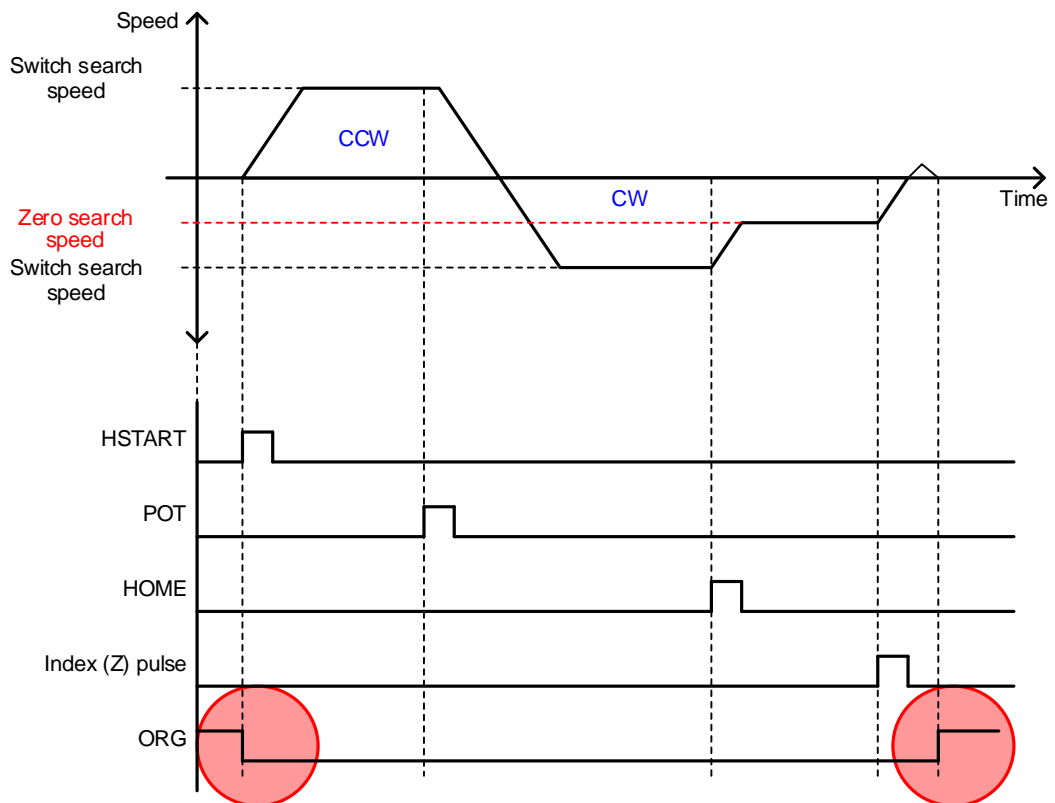

■ JSTART/JDIR

During machine adjustment, home position adjustment, etc., you can use JOG operation for movement to a certain position. A JSTART signal input from outside starts JOG operation, and a JDIR signal input from outside can change the direction of rotation to run the servo motor. To stop operation, it is advisable to use the STOP signal input from outside. When the JSTART signal is turned on, the index is in the Velocity Control Mode, and when it is off, the mode switches to the operation mode.

Related Object Names	Settings
Jog Operation Speed (0x2300)	Refer to Section 10.4, "Velocity Control Settings."
Speed command acceleration time (0x2301)	
Speed command deceleration time (0x2302)	
Speed command S curve time (0x2303)	

- Servo motor rotation direction

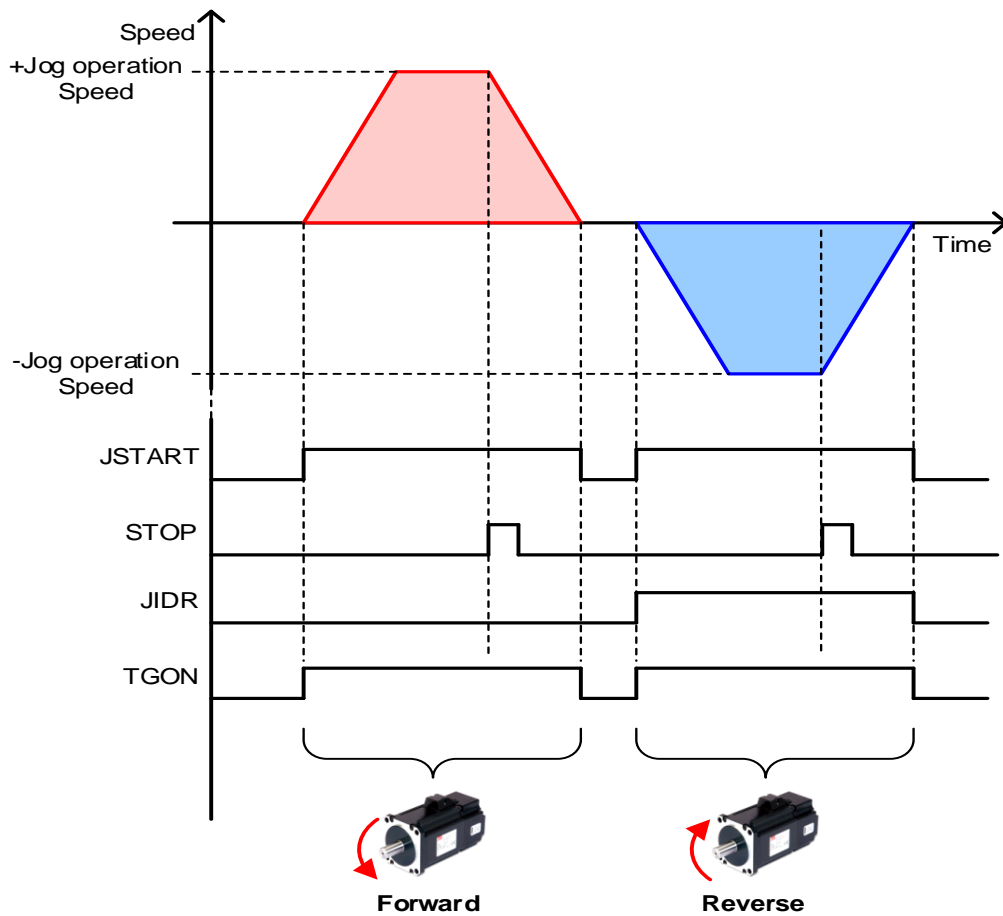

## 5.4 Function of Index Output Signal

### ■ EOS (Index Sequence end)

When an index action ends, an EOS (End of Sequence) signal is output. EOS is output if Position Demand Value reaches the target position and Position Actual Value has not reached the target position while the motor is moving from 0 [UU] to 52428800 [UU].

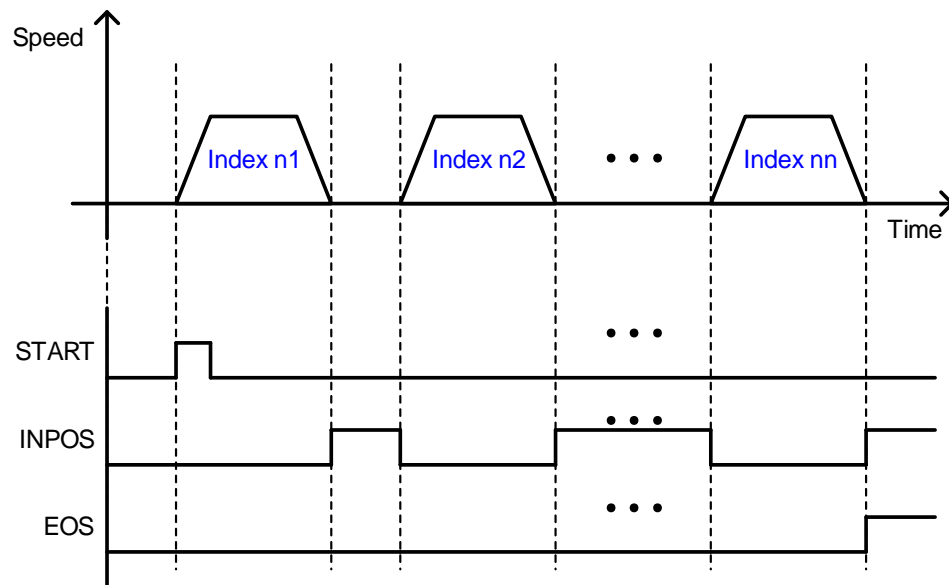

■ IOUT0~5 (Index Output 0~5)

The number of the index in operation is output through IOUT0~5. The output status operates according to the setting values of parameter 0x300A as shown below.

0x300A	IO Signal Configuration						ALL
Variable Type	Setting Range	Initial Value	Unit	Accessi bility	PDO Assignm ent	Variable Attribute	Savin g
UINT	0 to 5	0	-	RW	No	Always	Yes

I/O Signal Configuration [0x300A]

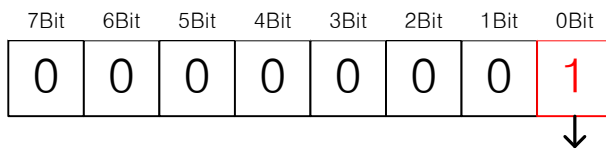

Setting Values	Setting Details
0	The applicable IOUT signal is output during Indexing Position operation. When Indexing Position operation is completed, the completed IOUT signal is output.
1	The previously completed IOUT signal is output during Indexing Position operation. When Indexing Position operation is completed, the completed IOUT signal is output.

■ Setting Value: 0

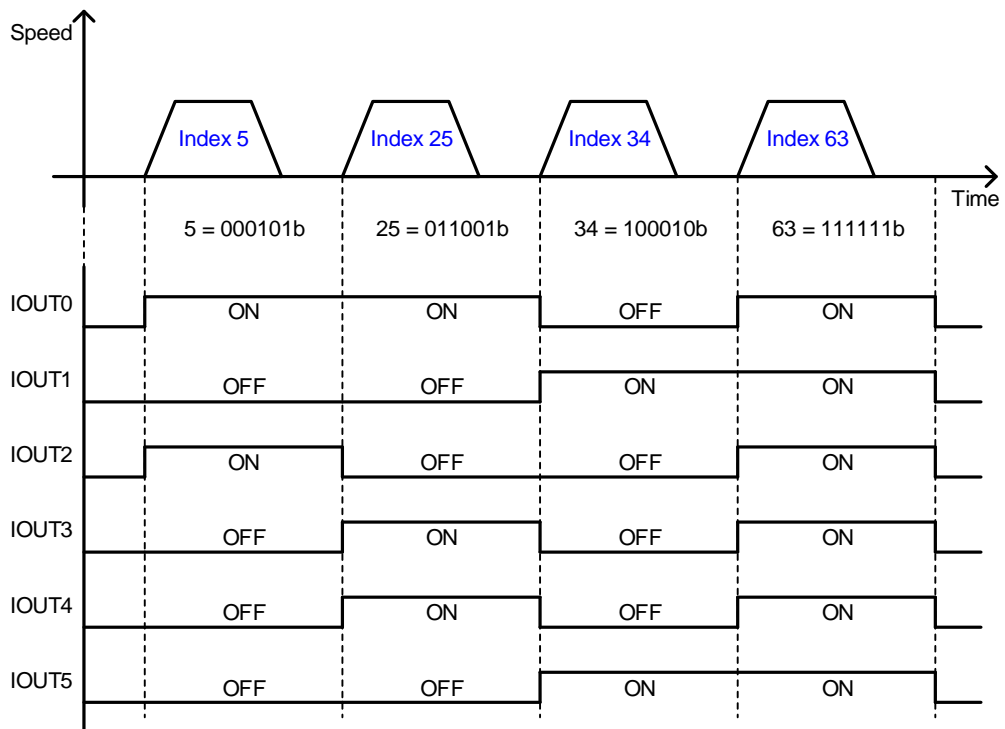

■ Setting Value: 1

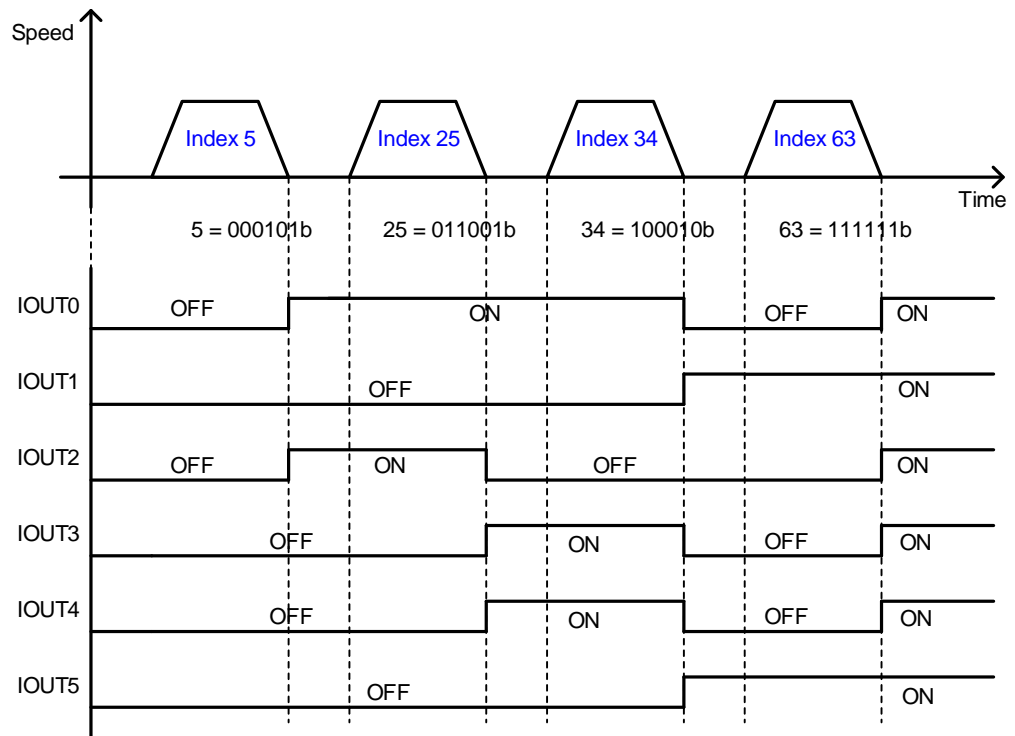

The current index position output signals are initialized when the operation mode is changed or the SVON signal is turned off (Motor free-run state). The initialized output state is identical to the operation status output of the number 0 index, which is why it is advisable to start with Index 1 whenever possible.

## 5.5 Analog Velocity Override

Index	Sub Index	Names	Variable Types	Accessibility	PDO Assignment	Unit
0x220F	-	Analog Velocity Override Mode	UINT	RW	Yes	-
0x2215	-	Analog Velocity (command/override) Offset	INT	RW	Yes	mV

As shown in the below figure, you can override the velocity of the index according to analog input during Indexing Position operation. This function is applied when the Analog Velocity Override Mode (0x220F) is enabled. You can enable the Analog Velocity Override offset (0x2215) to adjust the offset of input voltage. The unit is [mV].

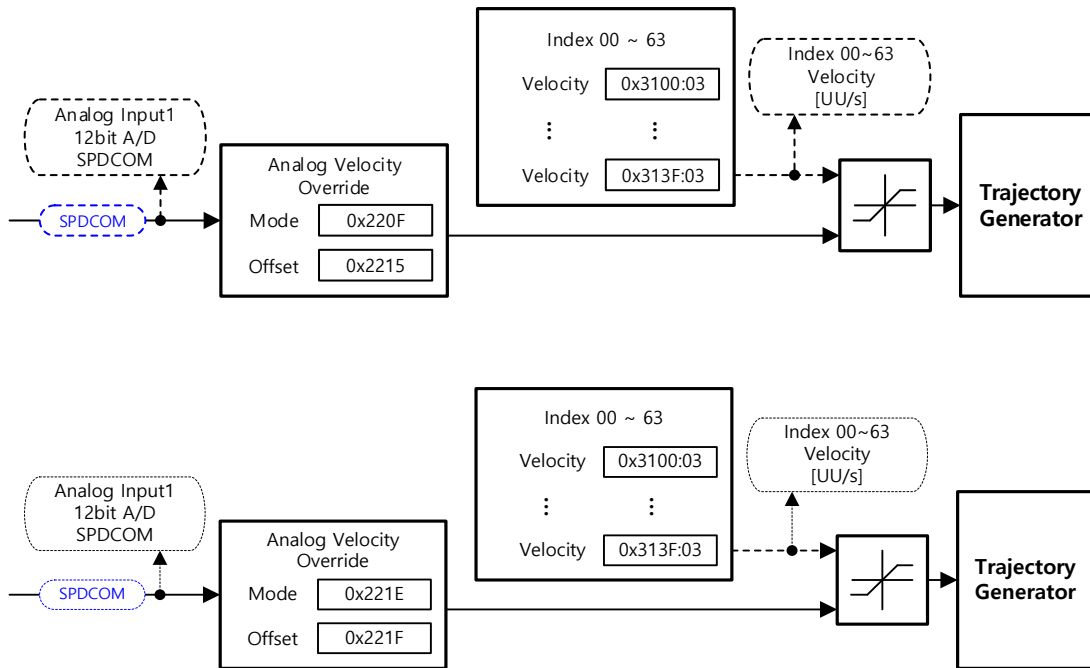



## ■ SPDCOM (Analog Velocity Override)

The Analog Velocity Override function is operated with the voltage versus velocity graph as the example below, according to the setting value of Analog Velocity Override Mode [0x220F]. For the operation velocity setting value, a 0[%] velocity override is applied for a -10[V] input, a 100[%] for a 0[V] input, and a 200[%] for a 10[V] input.

Setting Values	Setting Details
0	Analog Velocity Override is not used
1	Analog Velocity Override is used (-10[V]~10[V])
2	Analog Velocity Override is used (0[V]~10[V])

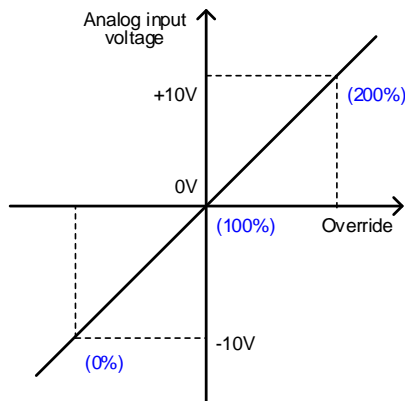

For 0x220F: 1

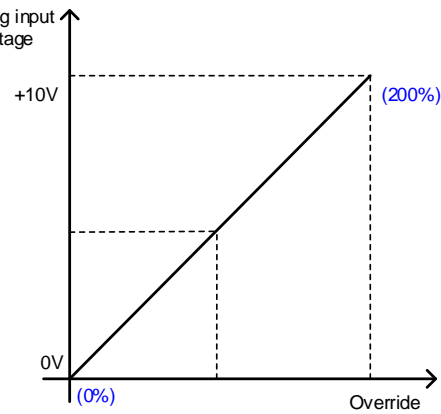

For 0x220F: 2

## ■ Related Objects

Index	Sub Index	Names	Variable Types	Accessibility	PDO Assignment	Unit
0x220F	-	Analog Velocity Override Mode	UINT	RW	Yes	-
0x2215	-	Analog Velocity Input (command/override) Offset	INT	RW	Yes	mV

## 5.6 Example of Indexing Operation Configuration Diagram

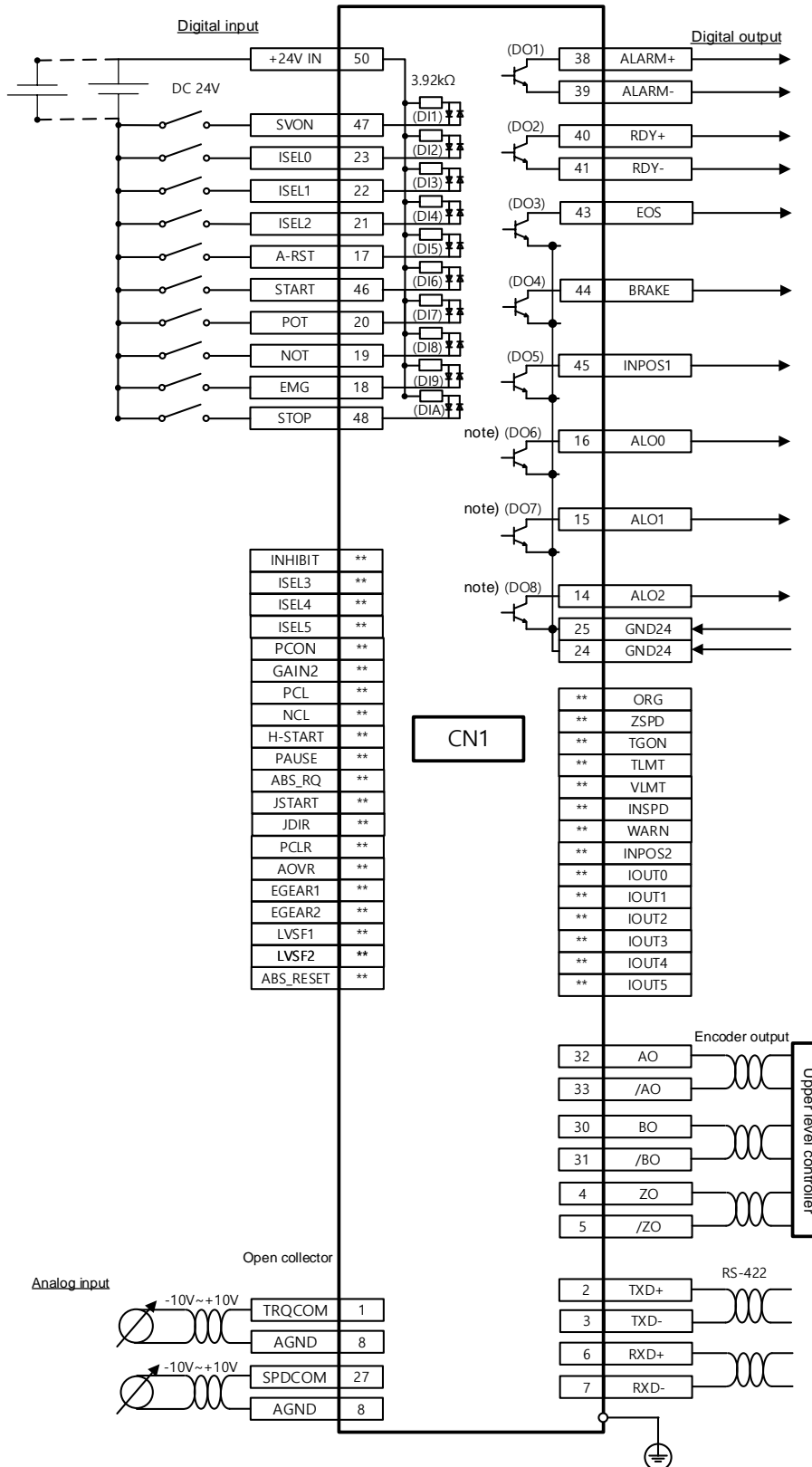

## 6. Pulse Input Position Operation

Control operation of Pulse Input Position is possible using the upper level controller which has the positioning function.

For this, you must set the control mode [0x3000] to 1.

The internal block diagram of the Pulse Input Position Control Mode is as follows.

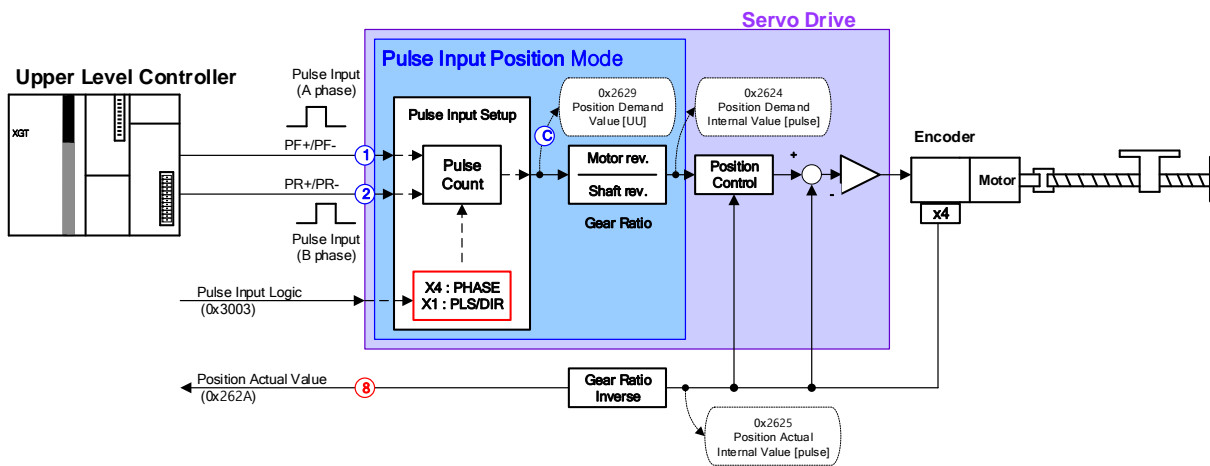

## 6.1 Pulse Input Logic Function Setting

You can set the logic of the pulse train input from the upper level controller. The following are the forms of input pulses and the rotation directions of the logic.

Setting Values	Setting Details
0	Phase A + Phase B, positive logic
1	CW + CCW, positive logic
2	Pulse + Sign, positive logic
3	Phase A + Phase B, negative logic
4	CW + CCW, negative logic
5	Pulse + Sign, negative logic

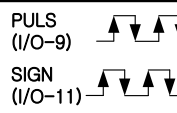
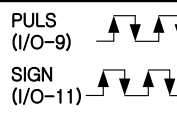
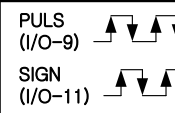
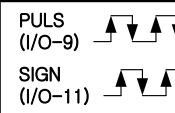
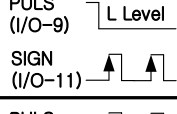
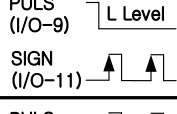
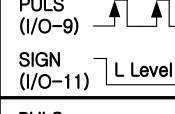
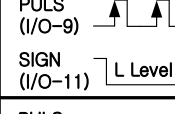
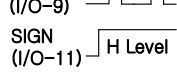
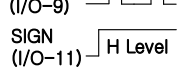
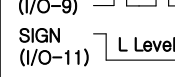
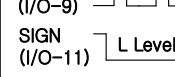
PF + PR		Forward rotation	Reverse rotation
Phase A +Phase B Positive logic	0	PULS (I/O-9)  SIGN (I/O-11) 	PULS (I/O-9)  SIGN (I/O-11) 
CW +CCW Positive logic	1	PULS (I/O-9)  SIGN (I/O-11) 	PULS (I/O-9)  SIGN (I/O-11) 
Pulse +Direction Positive logic	2	PULS (I/O-9)  SIGN (I/O-11) 	PULS (I/O-9)  SIGN (I/O-11) 

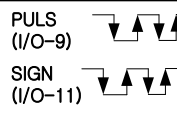
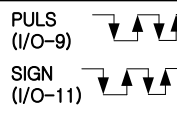
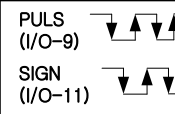
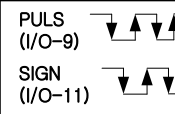
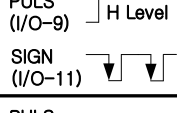
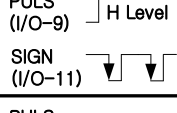
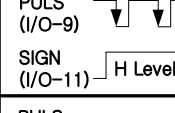
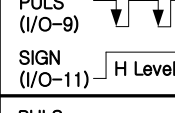
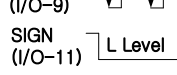
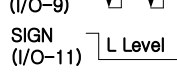
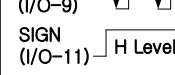
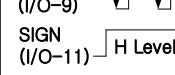
PF + PR		Forward rotation	Reverse rotation
Phase A +Phase B Negative logic	3	PULS (I/O-9)  SIGN (I/O-11) 	PULS (I/O-9)  SIGN (I/O-11) 
CW +CCW Negative logic	4	PULS (I/O-9)  SIGN (I/O-11) 	PULS (I/O-9)  SIGN (I/O-11) 
Pulse +Direction Negative logic	5	PULS (I/O-9)  SIGN (I/O-11) 	PULS (I/O-9)  SIGN (I/O-11) 

### ■ Related Objects

Index	Sub Index	Name	Variable Type	Accessibility	PDO Assignment	Unit
0x3003	-	Pulse Input Logic Select	UINT	RW	No	-

## 6.2 Pulse Input Logic Function Setting

You can set the frequency band of the digital filter set for the pulse input. You can use the function for the purpose of reducing wiring noise.

The frequency bands are determined based on the input pulse width in accordance with the digital filter's characteristics. Default value is 7 which is possible to filter below 1.6[MHz]. If input frequency is over 1.6[MHz], input pulses should be blocked. So value of setting details has to be changed.

Setting Values	Setting Details
0	50[MHz](NO Filter)
1	25[MHz]
2	12.5[MHz]
3	6.25[MHz]
4	4.167[MHz]
5	3.125[MHz]
6	2.083[MHz]
7	1.562[MHz] (Default)
8	1.042[MHz]
9	0.781[MHz]
10	625[kHz]
11	521[kHz]
12	391[kHz]
13	313[kHz]
14	260[kHz]
15	195[kHz]

### ■ Related Objects

Index	Sub Index	Name	Variable Type	Accessibility	PDO Assignment	Unit
0x3004	-	Pulse Input Filter Select	UINT	RW	No	-

## 6.3 Function Setting of PCLEAR

You can set the operation mode during input of position pulse clear (PCLR) signal. When the PCLR signal is input, the position tolerance inside the drive is set to 0.

Setting Values	Setting Details
0	Operate in Edge Mode
1	Operate in Level Mode (Torque: maintained)
2	Operate in Level Mode (Torque: 0)

### ■ Related Objects

Index	Sub Index	Name	Variable Type	Accessibility	PDO Assignment	Unit
0x3005	-	PCLEAR Mode Select	UINT	RW	No	-

## 6.4 Function Setting of INHIBIT

INHIBIT is a function that interrupts command pulse counting.

When the command pulse inhibit (INHIB) signal is input, the operation mode is set in I/O Configuration (0x2200~). This function is only active in PulseInputPosition operation. The input pulses generated after INHIB signal input do not count as command pulses.

Setting Values	Setting Details
ON	Turns on the command pulse inhibit function to block input pulses.
OFF	Turns off the command pulse inhibit function to count input pulses.

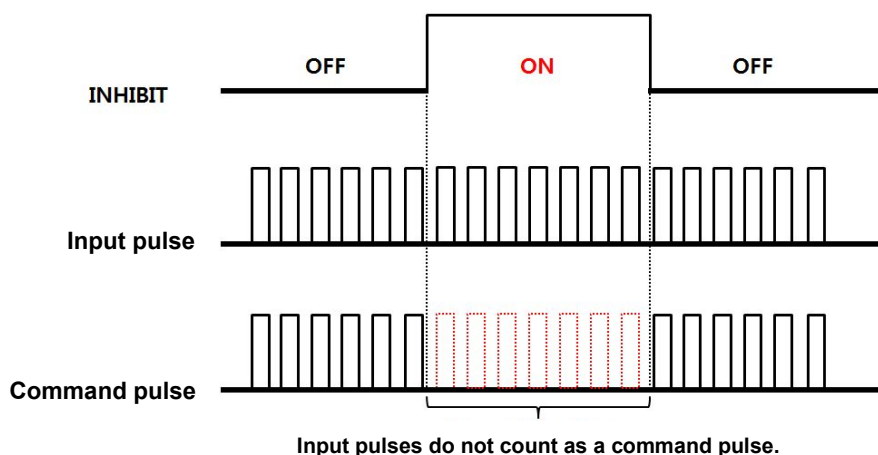

## 6.5 Example of Pulse Drive Mode Configuration Diagram

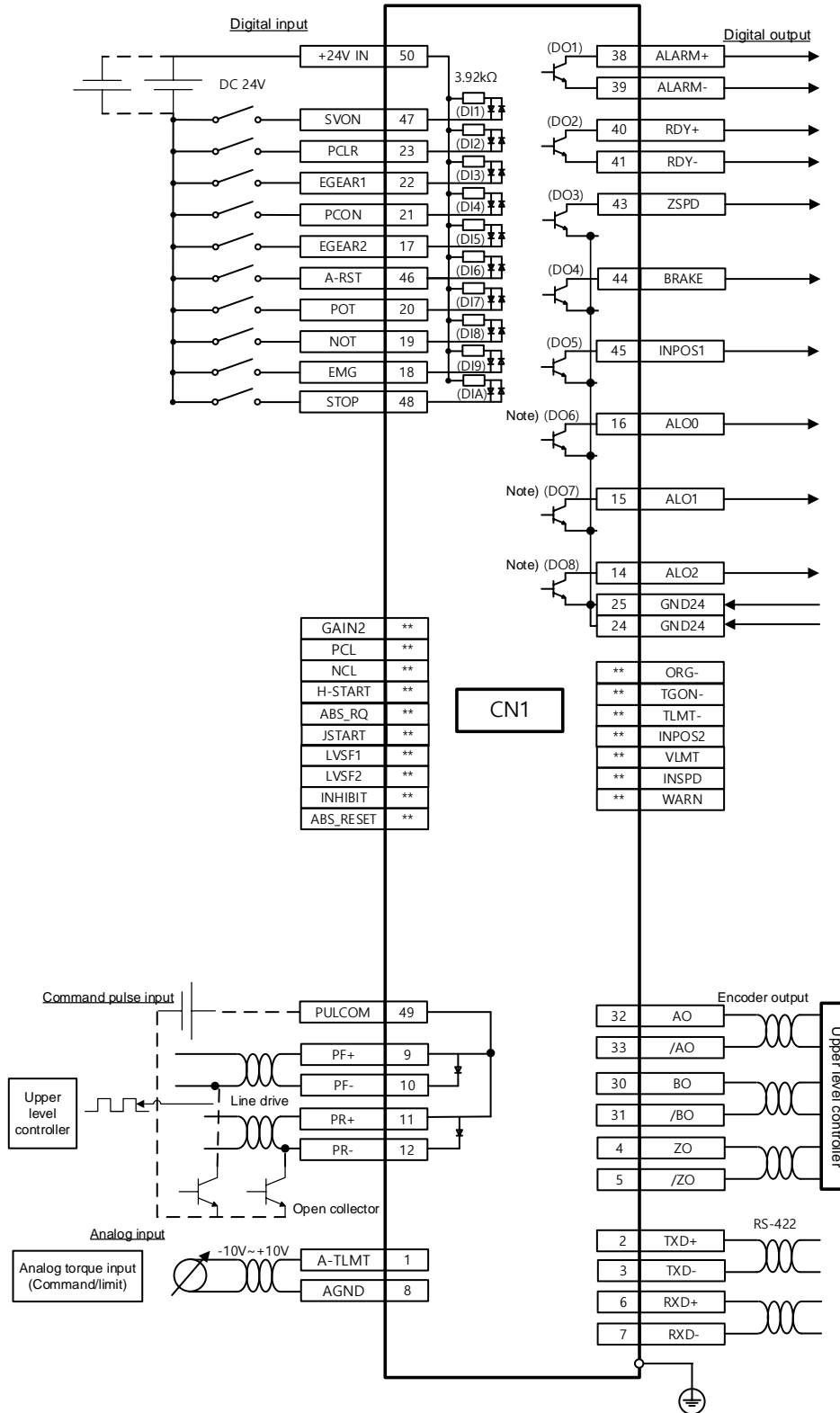





### 6.5.1.2 XGF-PD1/2/3A (Line Driver)

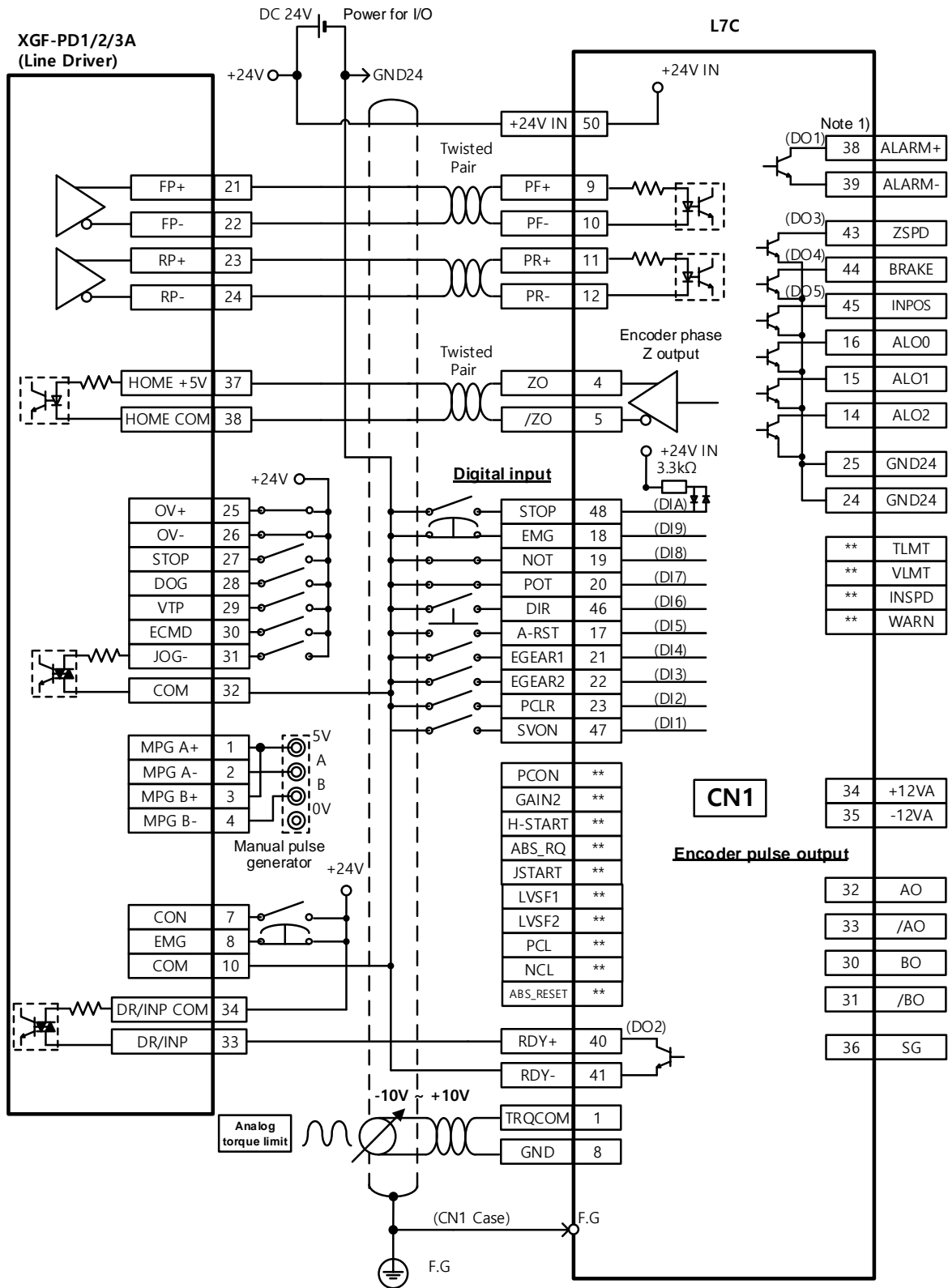

※ This is an example of a wiring diagram for a single shaft. For wiring with 2 or 3 shafts, refer to the pin arrangement for the positioning module.

### 6.5.1.3 XGF-PO1/2/3/4H (Open Collector)

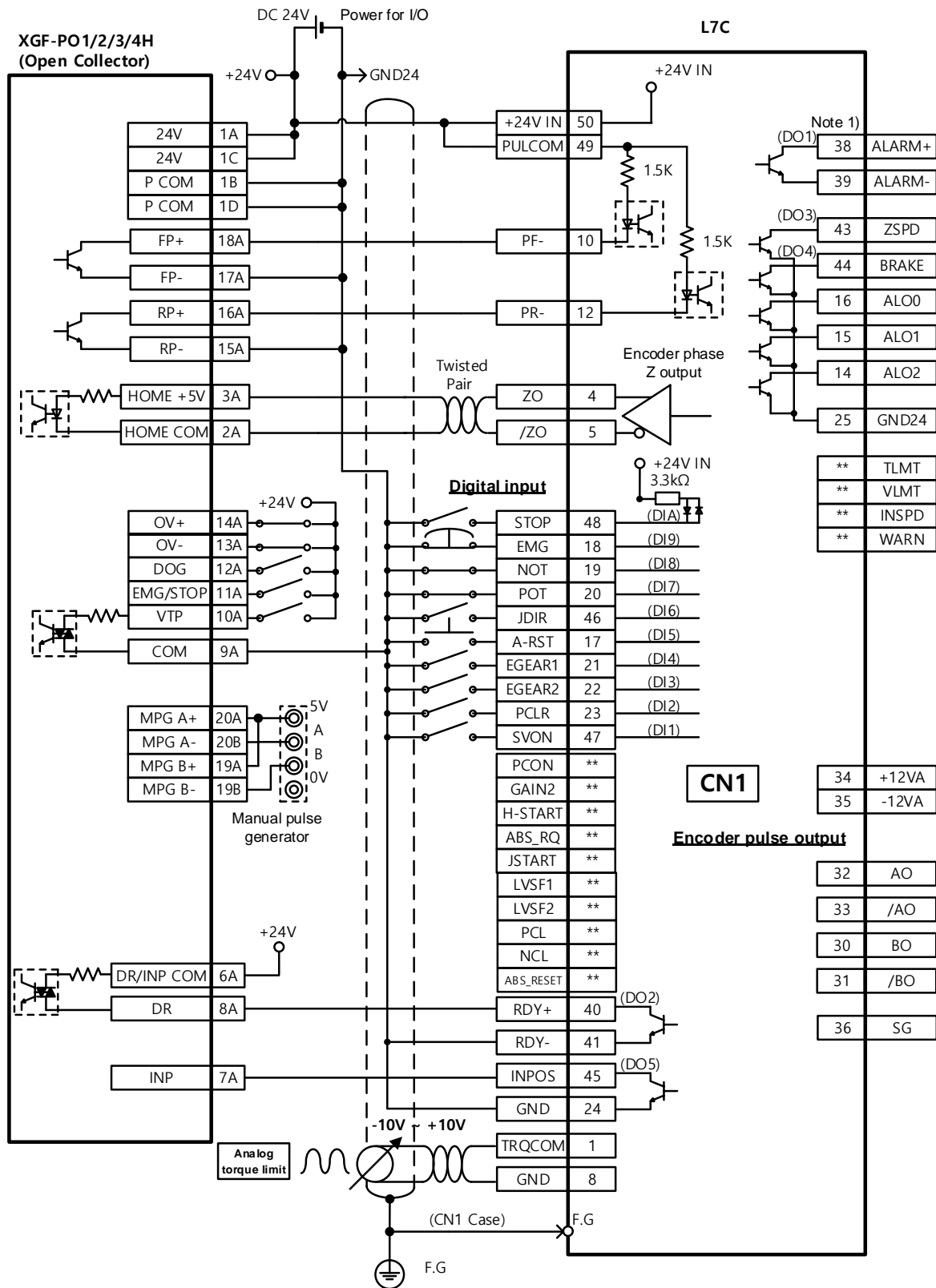

※ This is an example of a wiring diagram for a single shaft. For wiring with 2, 3, or 4 shafts, refer to the pin arrangement for the positioning module.

### 6.5.1.4 XGF-PD1/2/3/4H (Line Driver)

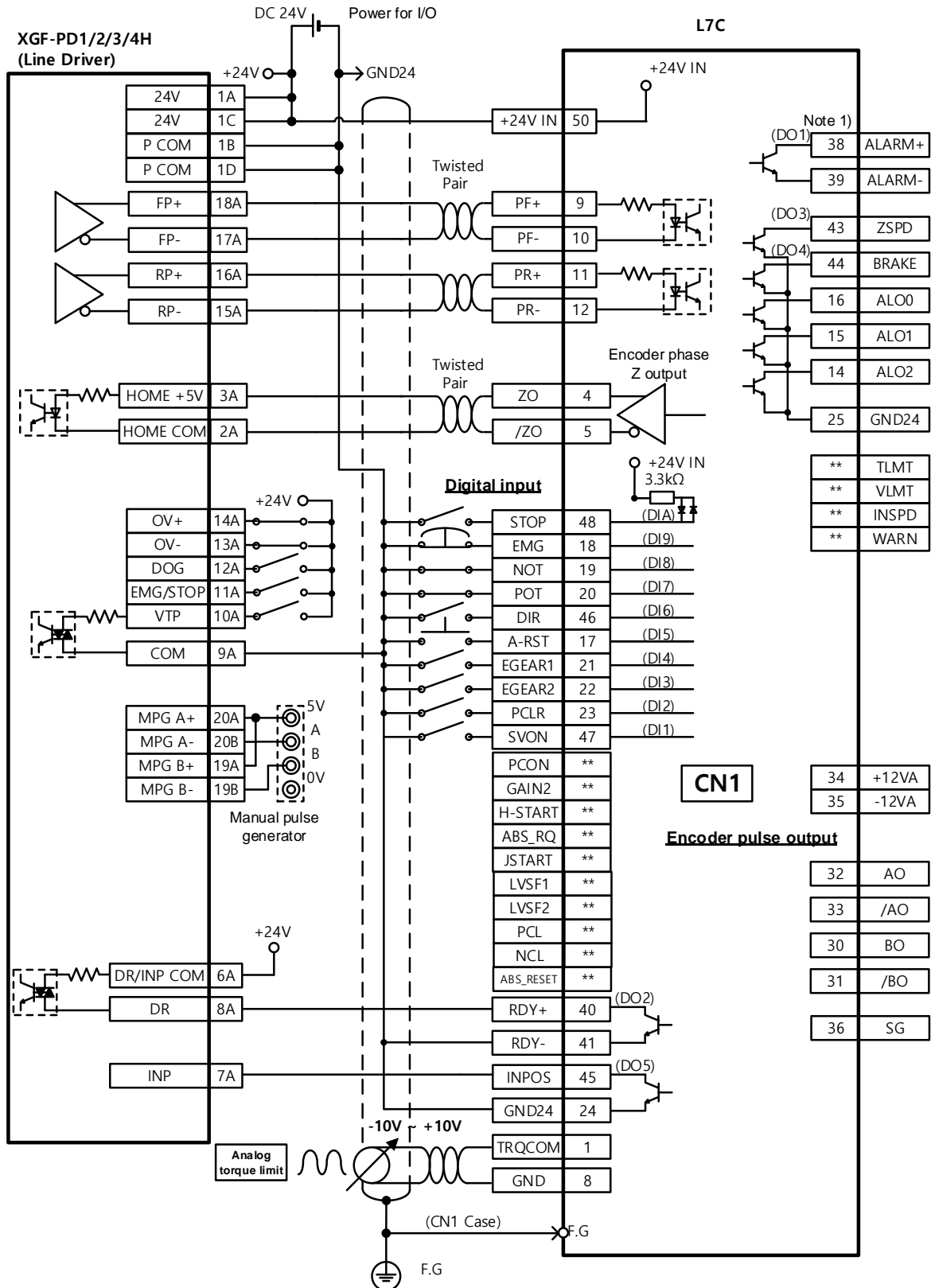

※ This is an example of a wiring diagram for a single shaft. For wiring with 2, 3, or 4 shafts, refer to the pin arrangement for the positioning module.

### 6.5.1.5 XBF-PD2A (Line Driver)

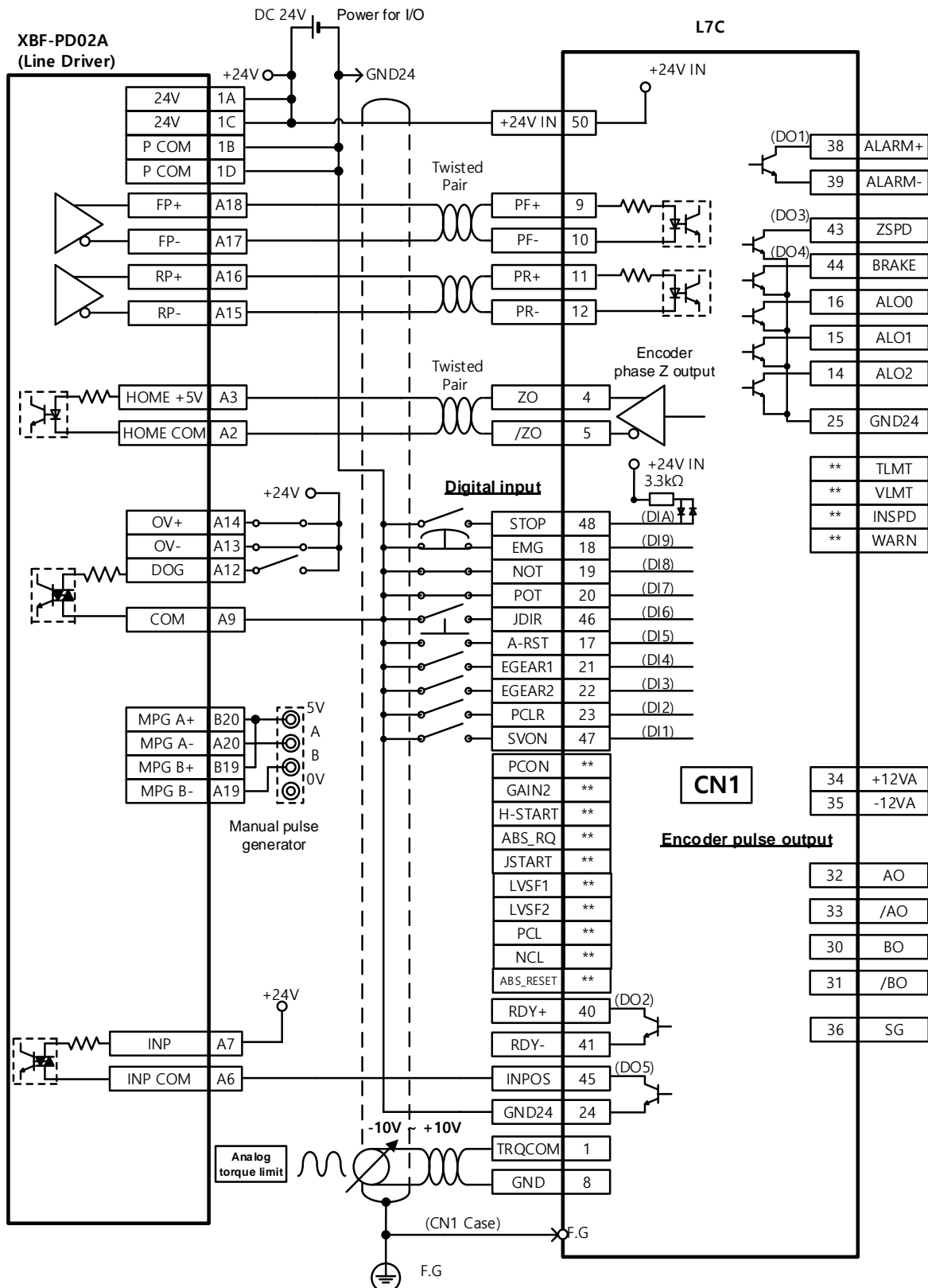

※ This is an example of a wiring diagram for a single shaft. For wiring with 2 shafts, refer to the pin arrangement for the positioning module.

### 6.5.1.6 XBM-DN\*\*S (Open Collector)

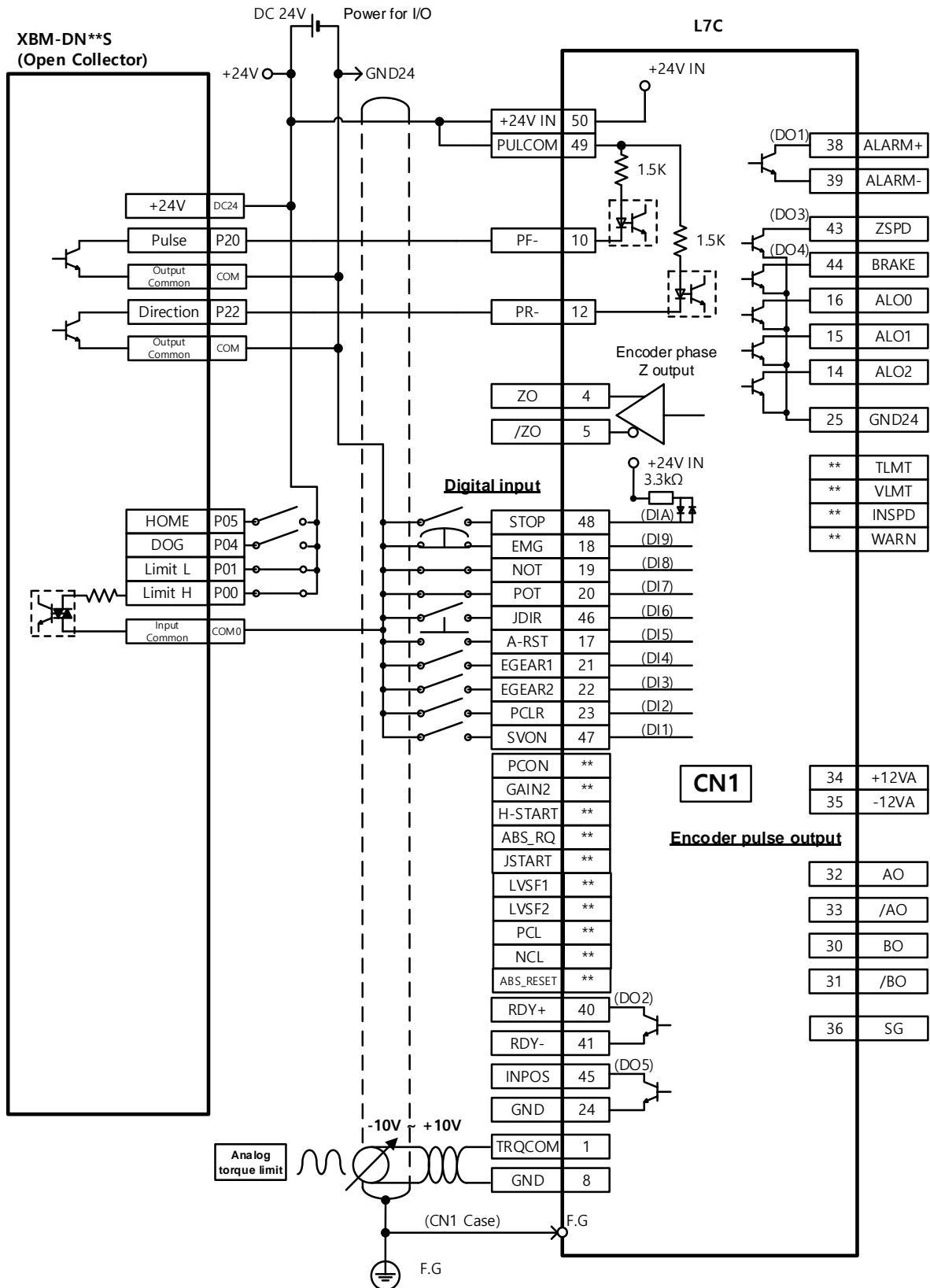

※ This is an example of a wiring diagram for a single shaft. For wiring with 2 shafts, refer to the pin arrangement for the positioning module.

### 6.5.1.7 XBC/XEC-DNxxH (Open Collector)

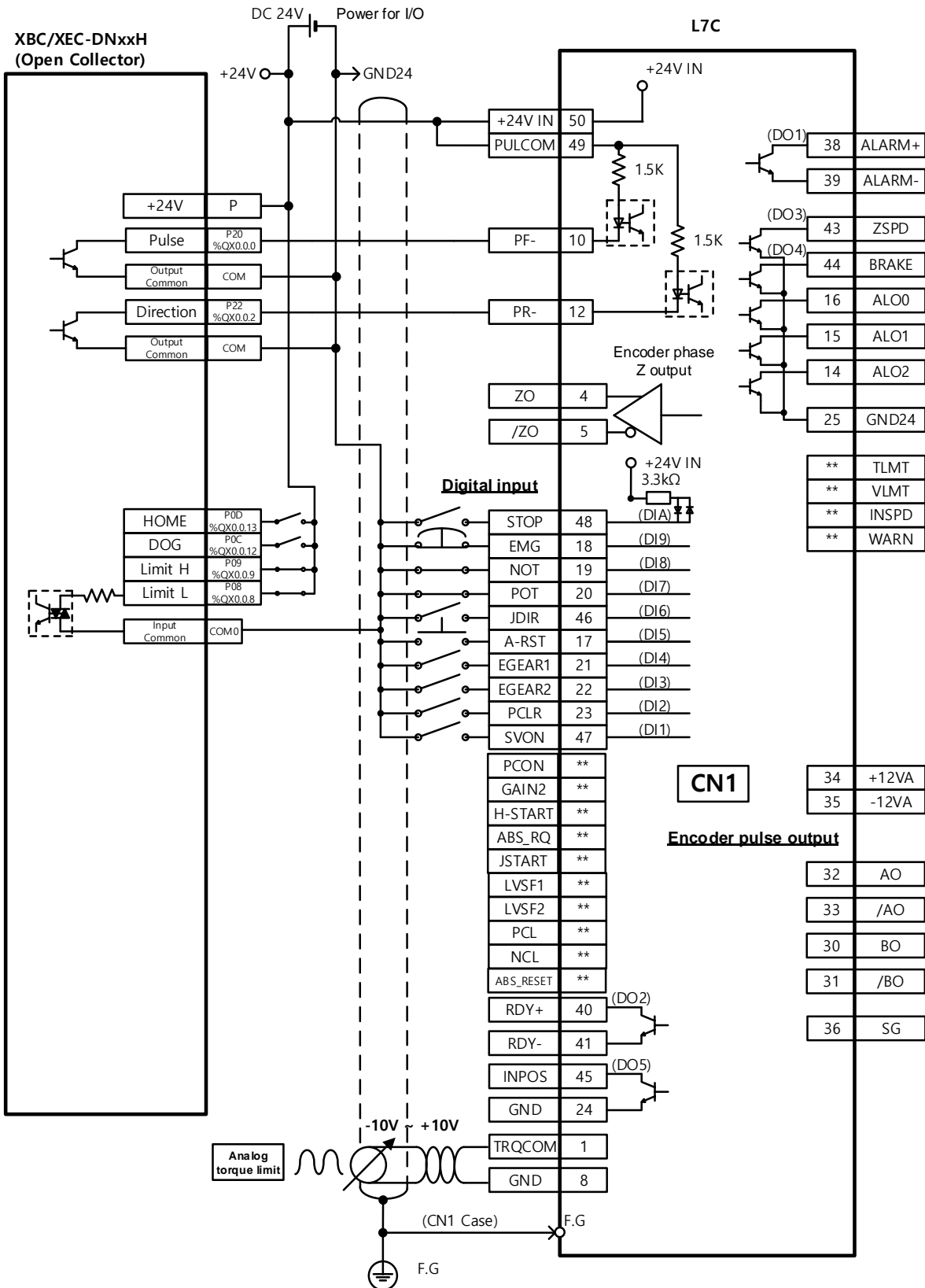

※ This is an example of a wiring diagram for a single shaft. For wiring with 2 shafts, refer to the pin arrangement for the positioning module.

## 7. Velocity Mode

### 7.1 Velocity Command Switch Select Function Setting

You can set the method of command to the servo drive for velocity operation.

Index	Sub Index	Name	Variable Type	Accessibility	PDO Assignment	Unit
0x231A	-	Velocity Command Switch Select	UINT	RW	No	-

Setting Values	Setting Details
0	Use analog velocity commands
1	Use SPD1, SPD2 contacts and analog velocity commands
2	Use SPD1, SPD2 and SPD3 contacts and analog velocity commands
3	Use velocity commands for SPD1, SPD2 and SPD3 contacts

Analog velocity commands are used when the setting value is 1 and all applicable contacts are turned on.

Input Devices			Velocity
SPD1	SPD2	SPD3	
X	X	Don't care	Multi-velocity command 1 (Parameter 0x2312)
O	X	Don't care	Multi-velocity command 2 (Parameter 0x2313)
X	O	Don't care	Multi-velocity command 3 (Parameter 0x2314)
O	O	Don't care	Use analog velocity commands

ex) Apply an analog velocity command of 10[V] when the setting value is 2 and SPD1, SPD2 contacts are turned on

Input Devices			Velocity
SPD1	SPD2	SPD3	
X	X	X	Multi-velocity command 1 (Parameter 0x2312)
O	X	X	Multi-velocity command 2 (Parameter 0x2313)
X	O	X	Multi-velocity command 3 (Parameter 0x2314)
O	O	X	Multi-velocity command 4 (Parameter 0x2315)
X	X	O	Multi-velocity command 5 (Parameter 0x2316)
O	X	O	Multi-velocity command 6 (Parameter 0x2317)
X	O	O	Multi-velocity command 7 (Parameter 0x2318)
O	O	O	Use analog velocity commands

Motor rotation operates at 100[rpm] and analog input velocity commands are ignored.

The operation velocity is set to the multi-velocity command according to the setting of parameter 0x2315.

## 7.2 Analog Velocity Command

When the setting values for velocity command switch select are 0, 1, and 2, you can operate velocity control by analog voltage from outside.

To input commands, apply voltage of  $-10[V] \sim +10[V]$  to pins 27 and 8 of the CN1 connector.

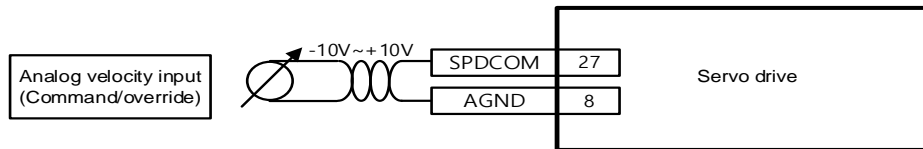

### ■ Related Objects

Index	Sub Index	Names	Variable Types	Accessibility	PDO Assignment	Unit
0x2214	-	Analog Velocity Command Scale	UINT	RW	No	-
0x2215		Analog Velocity Input (command/override) Offset	INT	RW	No	-
0x2216	-	Analog Velocity Command Clamp Level	UINT	RW	No	-
0x2217	-	Analog Velocity Command Filter Time Constant	UINT	RW	No	-



### ■ Analog Velocity Command Scale

The analog velocity command is set in the unit of [rpm] for each input of 1[V]. When the command voltage is the opposite value, only the rotation direction needs to be changed from the (-) setting value.

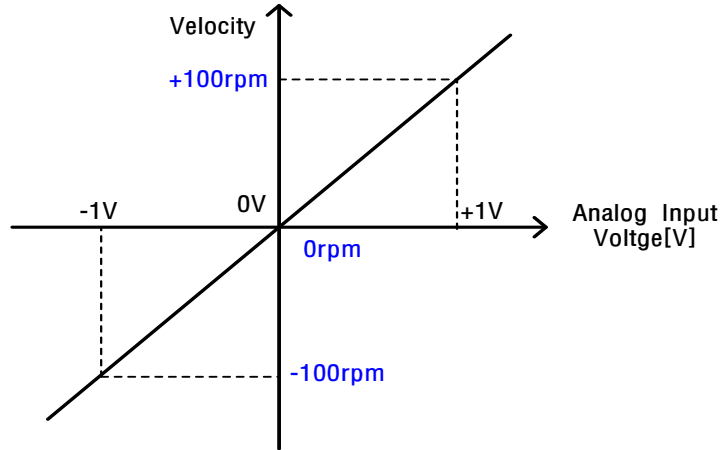

### ■ Analog Velocity Command Clamp Level

There are cases where a certain level of voltage remains in the analog signal access circuit, even at the 0 speed command.

Here, the 0 velocity can be maintained for the voltage command for the setting velocity value.

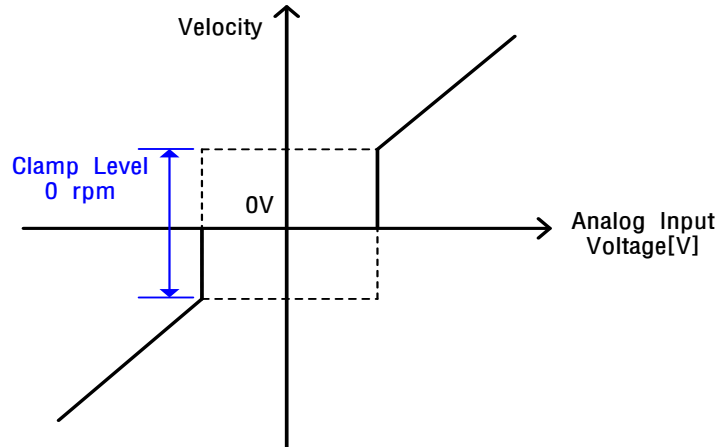

## 7.3 Multi-Velocity Command

When the setting values for velocity command switch select are 1, 2, and 3, you can operate velocity control by using the internal multi-velocity of the servo drive.

To use the digital velocity command, assign digital input signals of SPD1, SPD2 and SPD3 to the CN1 connector or control the digital input signals of SPD1, SPD2 and SPD3 via communication.

### ■ Velocity Settings by Digital Input Signal

Input Devices			Velocity
SPD1	SPD2	SPD3	
X	X	X	Multi-velocity command 1 (Parameter 0x2312)
O	X	X	Multi-velocity command 2 (Parameter 0x2313)
X	O	X	Multi-velocity command 3 (Parameter 0x2314)
O	O	X	Multi-velocity command 4 (Parameter 0x2315)
X	X	O	Multi-velocity command 5 (Parameter 0x2316)
O	X	O	Multi-velocity command 6 (Parameter 0x2317)
X	O	O	Multi-velocity command 7 (Parameter 0x2318)
O	O	O	Multi-velocity command 8 (Parameter 0x2319)

# 7.4 Example of Velocity Mode Configuration Diagram

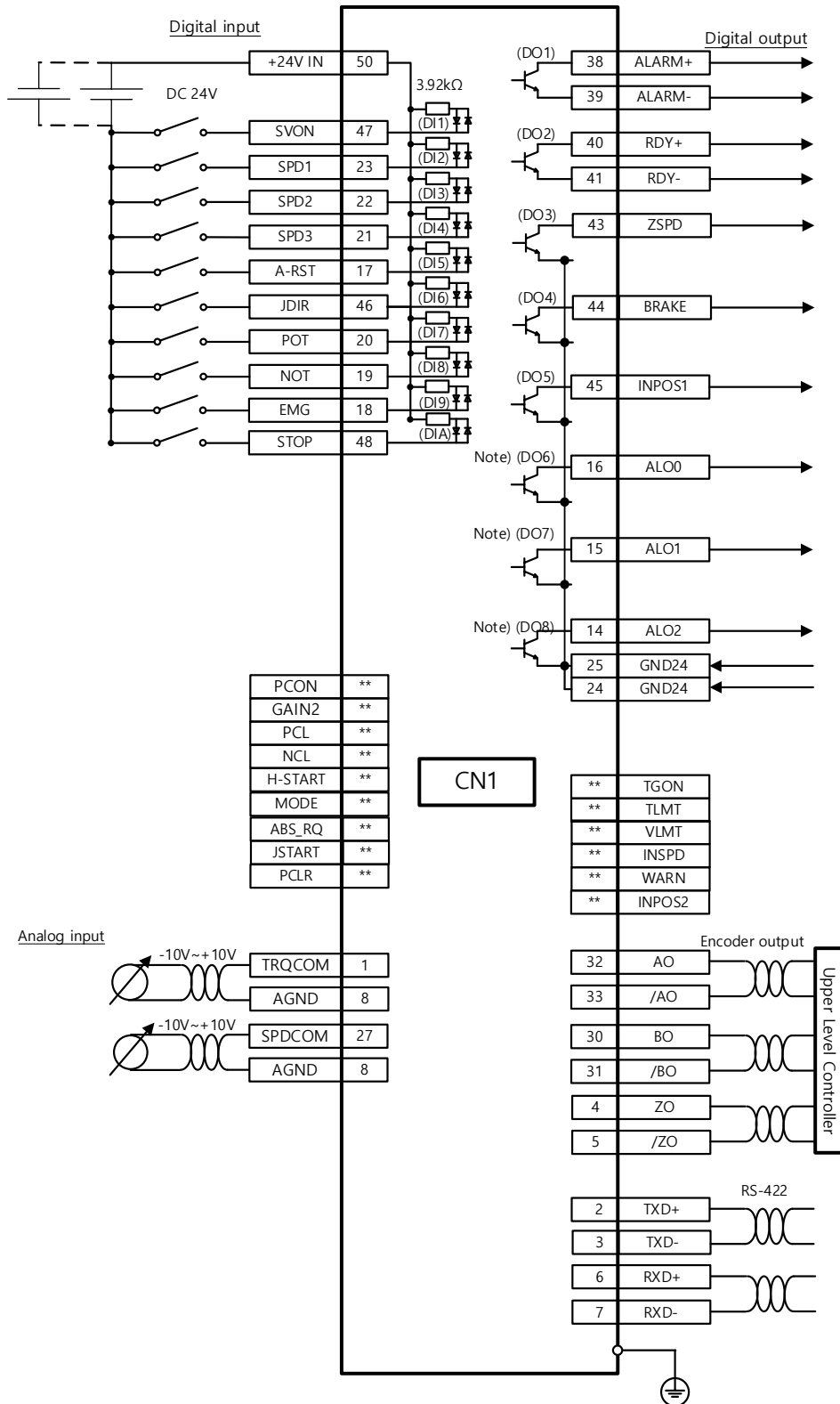



## 8. Torque Operation

### 8.1 Analog Torque Command Scale

The analog torque command is set in the unit of [0.1%] for each input of 1[V].

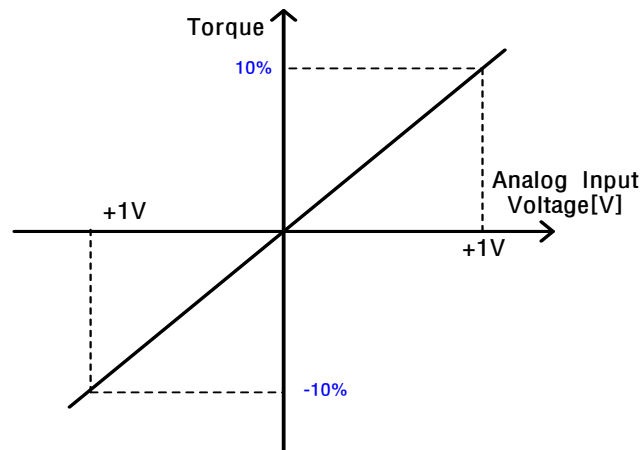

The related object is the 0x2210 analog torque input (command/limit) scale, which consists of two functions.

0x2210	Analog Torque Input (command/limit) Scale						ALL
Variable Type	Setting Range	Initial Value	Unit	Accessi- bility	PDO Assignm- ent	Variable Attribute	Savin- g
UINT	-1000 to 1000	100	0.1%/V	RW	No	Always	Yes

First, for non-torque operation

If the setting value of the torque limit function (0x2110) is 4 (analog torque limit), torque is limited by the analog input torque limit. Here, set the scale of the analog input value.

Second, for torque-operation

For torque operation, the parameter is used as the analog torque command scale. The setting value is set to the torque command value at the analog input voltage of  $\pm 10$ [V] in percentage of the rated torque.

## 8.2 Velocity Setting for Torque Operation

For torque operation, the motor speed is determined according to the 0x230D Speed Limit Function Select.

Setting Values	Setting Details
0	Limited by speed limit value (0x230E) at torque control
1	Limited by the maximum motor speed

For 0x230E torque control, the default speed limit is set to 1000 [rpm].

Enter the desired velocity value before operation.

### ■ Related Objects

Index	Sub Index	Names	Variable Types	Accessibility	PDO Assignment	Unit
0x2210	-	Analog Torque Input (command/limit) Scale	UINT	RW	No	-
0x2211	-	Analog Torque Input (command/limit) Offset	INT	RW	No	-
0x2212		Analog Torque Command Clamp Level	INT	RW	No	
0x2213	-	Analog Torque Command Filter Time Constant	UINT	RW	No	-
0x230D	-	Speed Limit Function Select	UINT	RW	No	-
0x230E	-	Velocity Limit Value at Torque Control Mode	UINT	RW	No	-

### 8.3 Example of Torque Mode Configuration Diagram

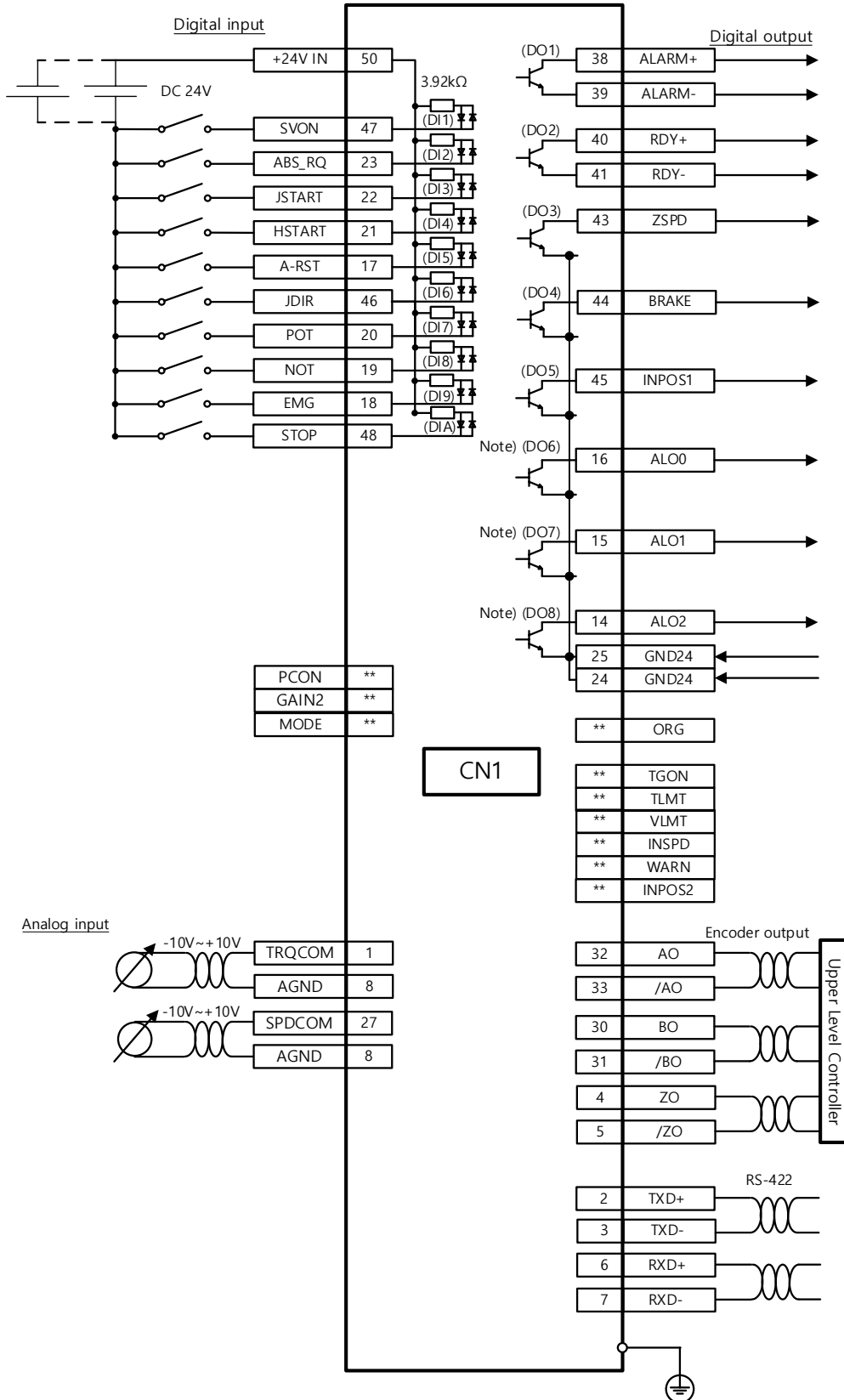





## 9. Operation Mode Switching

The device supports operation modes switching according to the setting value of L7C drive control mode (0x3000) and digital input mode signals.

### ■ Control Mode (0x3000) Setting Values

Setting Values	Setting Details
0	Indexing Position Mode
1	Pulse Input Position Mode
2	Velocity Mode
3	Torque Mode
4	Pulse Input Position Operation or Indexing Position Operation
5	Pulse Input Position Operation or Velocity Mode
6	Pulse Input Position Operation or Torque Mode
7	Velocity Mode or Torque Mode
8	Indexing Position Mode or Velocity Mode
9	Indexing Position Mode or Torque Mode

You can switch the operation modes by using the setting value and the MODE signal. For example, setting the value to 7 enables operation in the velocity mode with power supply, and a MODE signal input switches the mode to torque operation.

ControlMode Setting Value	MODE Signal	
	OFF (Basic Operation)	ON
4	Pulse Input Position Operation	Indexing Position Operation
5	Pulse Input Position Operation	Velocity Operation
6	Pulse Input Position Operation	Torque Operation
7	Velocity Operation	Torque Operation
8	Indexing Position Operation	Velocity Operation
9	Indexing Position Operation	Torque Operation

■ **Control Mode Setting Value: 4**

Pulse Input Position Operation is the basic operation, and a digital input MODE signal switches the mode to Indexing Position Operation.

■ **Control Mode Setting Value: 5**

This setting performs pulse input position operation as the default. When the digital input mode signal is received, it switches to the speed operation mode.

■ **Control Mode Setting Value: 6**

Pulse Input Position Operation is the basic operation, and a digital input MODE signal switches the mode to Torque Operation.

■ **Control Mode Setting Value: 7**

Velocity Operation is the basic operation, and a digital input MODE signal switches the mode to Torque Operation.

■ **Control Mode Setting Value: 8**

This setting performs index position operation as the default. When the digital input mode signal is received, it switches to the speed operation mode.

■ **Control Mode Setting Value: 9**

Indexing Position Operation is the basic operation, and a digital input MODE signal switches the mode to Torque Operation.

# 10. Homing

This drive provides its own homing function (return to origin). The figure below represents the relationship between the input and output parameters for the Homing Mode. You can specify velocity, acceleration, offset, and homing method.

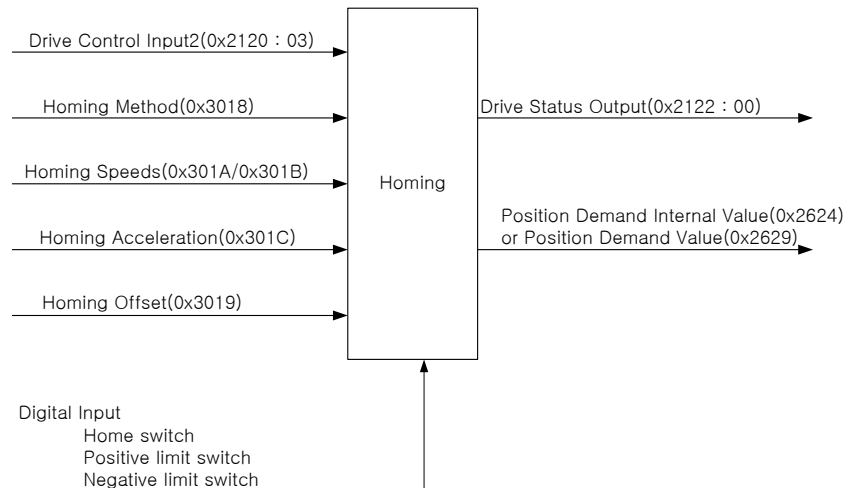

As shown in the figure below, you can set the offset between the home position and the zero position of the machine using the home offset function. The zero position indicates the point whose Position Actual Value (0x262A) is zero (0).

Also, keep in mind that homing can be performed only if the HSTART signal is input when the ZSPD (Zero Speed) output includes the High signal input.

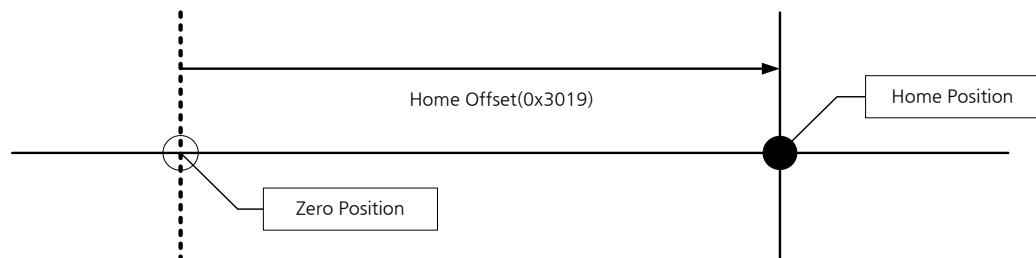

## 10.1 Homing Method

The drive supports the following homing methods (0x3018).

Homing Methods (0x3018)	Descriptions
1	The drive returns to the home position by the negative limit switch (NOT) and the Index (Z) pulse while driving in the reverse direction.
2	The drive returns to the home position by the positive limit switch (POT) and the Index (Z) pulse while driving in the forward direction.
7,8,9,10	The drive returns to the home position by the home switch (HOME) and the Index (Z) pulse while driving in the forward direction. When the positive limit switch (POT) is input during homing, the drive switches its driving direction.
11,12,13,14	The drive returns to the home position by the home switch (HOME) and the Index (Z) pulse while driving in the reverse direction. When the negative limit switch (NOT) is input during homing, the drive switches its driving direction.
24	The drive returns to the home position by the home switch (HOME) while driving in the forward direction. When the positive limit switch (POT) is input during homing, the drive switches its driving direction.
28	The drive returns to the home position by the home switch (HOME) while driving in the reverse direction. When the negative limit switch (NOT) is input during homing, the drive switches its driving direction.
33	The drive returns to the home position by the Index (Z) pulse while driving in the reverse direction.
34	The drive returns to the home position by the Index (Z) pulse while driving in the forward direction.
35	Sets the current position as the home position.
-1	The drive returns to the home position by the negative stopper and the Index (Z) pulse while driving in the reverse direction.
-2	The drive returns to the home position by the positive stopper and the Index (Z) pulse while driving in the forward direction.
-3	The drive returns to the home position only by the negative stopper while driving in the reverse direction.
-4	The drive returns to the home position only by the positive stopper while driving in the forward direction.
-5	The drive returns to the home position only by the home switch (HOME) while driving in the reverse direction.
-6	The drive returns to the home position only by the home switch (HOME) while driving in the forward direction.

## ■ Related Objects

Index	Sub Index	Names	Variable Types	Accessibility	PDO Assignment	Unit
0x2120	-	Drive Control Input2	UINT	RW	Yes	-
0x2122	-	Drive Status Output2	UINT	RO	Yes	-
0x3019	-	Home Offset	DINT	RW	No	UU
0x3018	-	Homing Method	SINT	RW	Yes	-
0x301A	1	Speed during search for switch	UDINT	RW	Yes	UU/s
0x301B	2	Speed during search for zero	UDINT	RW	Yes	UU/s
0x301C	-	Homing Acceleration	UDINT	RW	Yes	UU/s <sup>2</sup>

## ■ Homing Methods 1 and 2

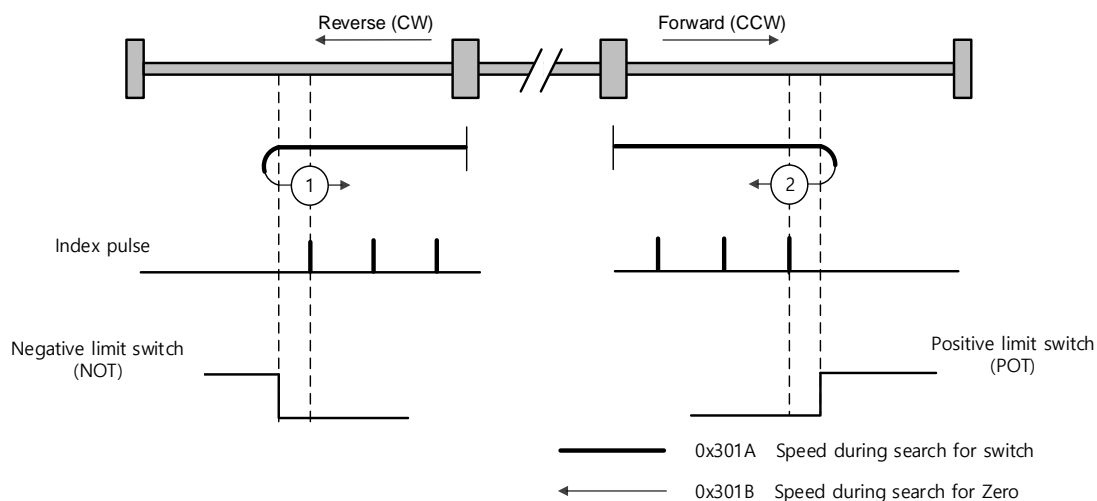

For homing using the homing method 1, the velocity profile according to the sequence is as follows. Refer to the description below.

**Homing Method ①**

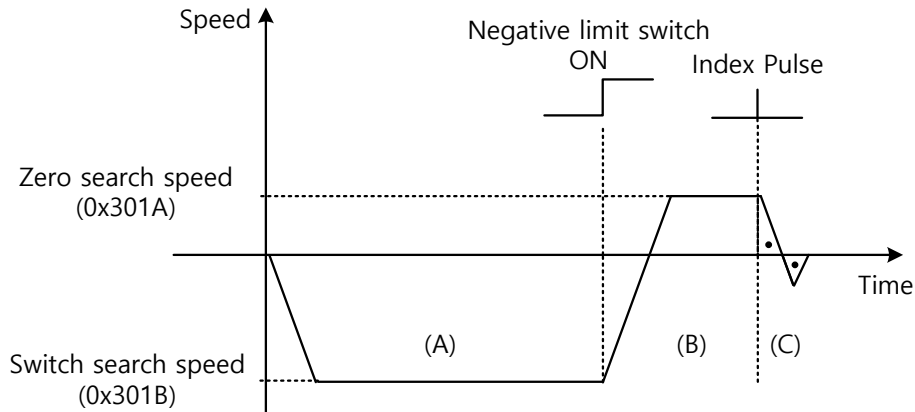

- (A) The initial driving direction is reverse (CW), and the drive operates at the switch search speed.
- (B) When the negative limit switch (NOT) is turned on, the drive switches its direction to the forward direction (CCW) and decelerates to the zero search speed.
- (C) While operating at the zero search speed, the drive detects the first index pulse to move to the index position (Home).

**■ Methods 7, 8, 9 and 10**

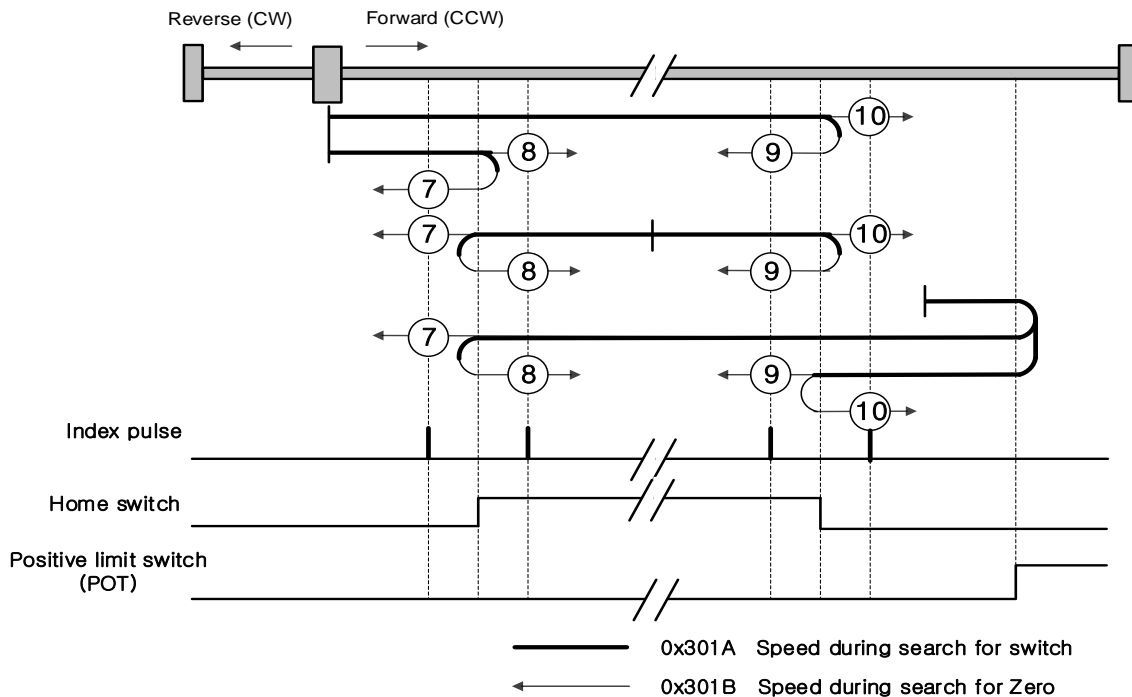

For homing using the homing method 7, the velocity profile according to the sequence is as follows. The sequence varies depending on the relationship between the load position and the home switch during homing, which is categorized into three cases as below. For more information, see the details below.

- (1) At the start of homing, the home switch is off and the limit is not met during operation

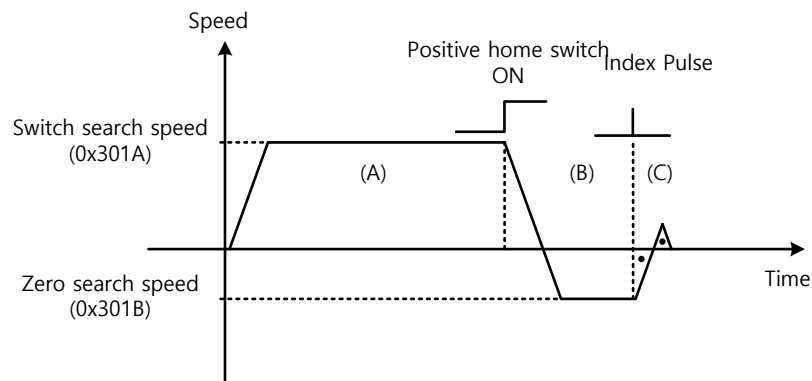
**Homing Method ⑦**

- (A) The initial driving direction is forward (CCW), and the drive operates at the switch search speed.
- (B) When the positive home switch is turned on, the drive decelerates to the zero search speed and switches its direction to the reverse direction (CW).
- (C) While operating at the zero search speed, the drive detects the first index pulse to move to the index position (Home).

(2) At the start of homing, the home switch is on

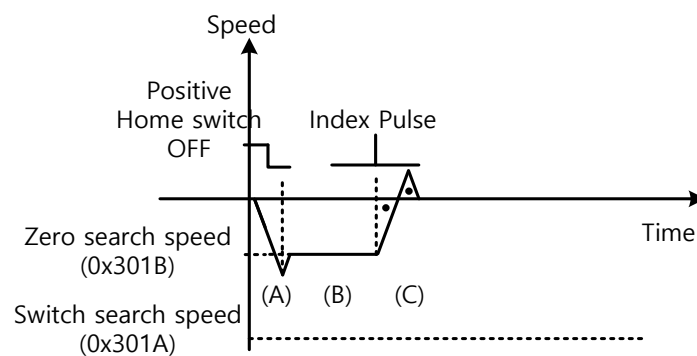
**Homing Method ⑦**

- (A) Since the home signal is on, the drive operates at the switch search speed in the direction of the positive home switch (CCW). It may not reach the switch search speed depending on the start position of homing.
- (B) When the home switch is turned off, the drive decelerates to the zero search speed, then continues to operate.
- (C) While operating at the zero search speed, the drive detects the first index pulse to move to the index position (Home).

(3) At the start of homing, the home switch is off and the limit is met during operation

### Homing Method ⑦

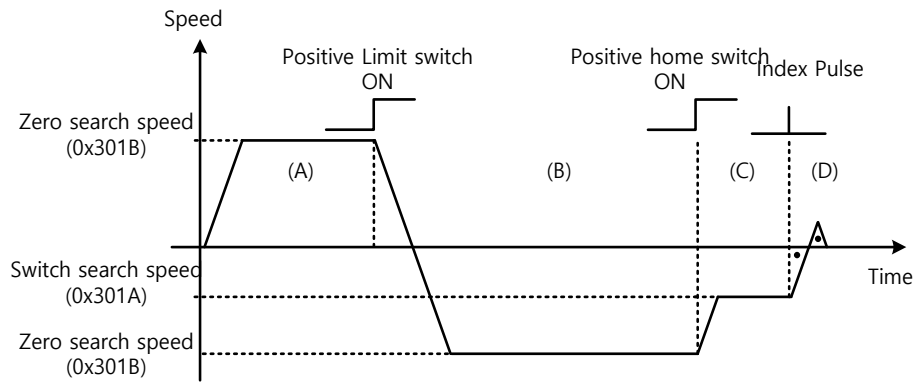

- (A) The initial driving direction is forward (CCW), and the drive operates at the switch search speed.
- (B) When the positive limit switch (POT) is turned on, the drive decelerates to a stop, then operates at the switch search speed in the reverse direction (CW).
- (C) When the positive home switch is turned off, the drive decelerates to the zero search speed, then continues to operate.
- (D) While operating at the zero search speed, the drive detects the first index pulse to move to the index position (Home).

Methods 8, 9, and 10 are nearly identical to method 7 in terms of homing sequence. The only differences are the initial driving direction and the home switch polarity.



The positive home switch is determined by the initial driving direction. The home switch encountered in the initial driving direction becomes the positive home switch.

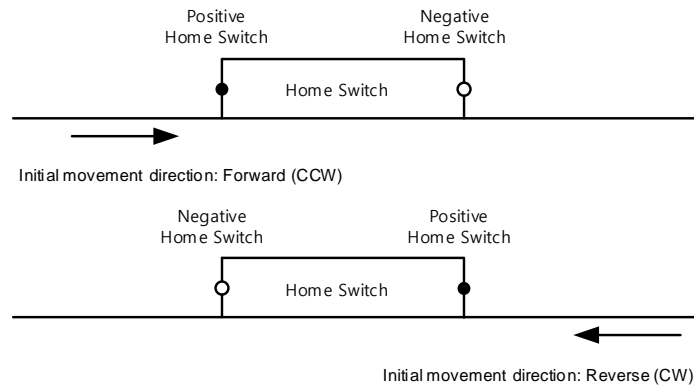

■ **Methods 11, 12, 13, and 14**

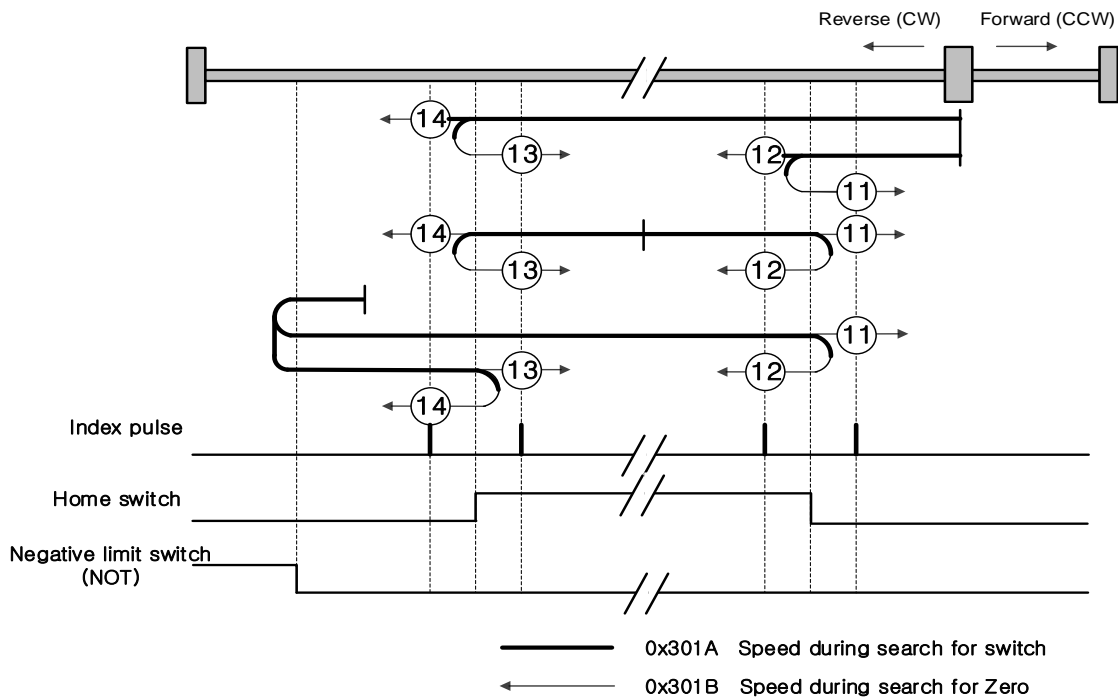

For homing using Homing Method 14, the velocity profile according to the sequence is as follows. The sequence varies depending on the relationship between the load position and the home switch during homing, which is categorized into three cases as below. For more information, see the details below.

(1) At the start of homing, the home switch is off and the limit is not met during operation

**Homing Method ⑭**

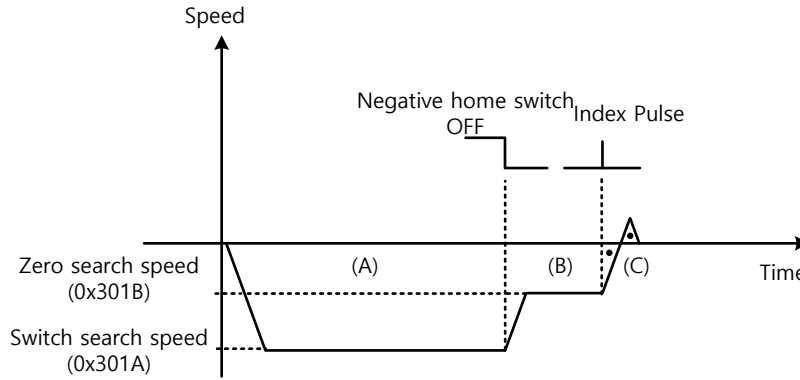

- (A) The initial driving direction is reverse (CW), and the drive operates at the switch search speed.
- (B) When the negative home switch is turned off, the drive decelerates to the zero search speed, then continues to operate.
- (C) While operating at the zero search speed, the drive detects the first index pulse to move to the index position (Home).

(2) At the start of homing, the home switch is on

**Homing Method ⑭**

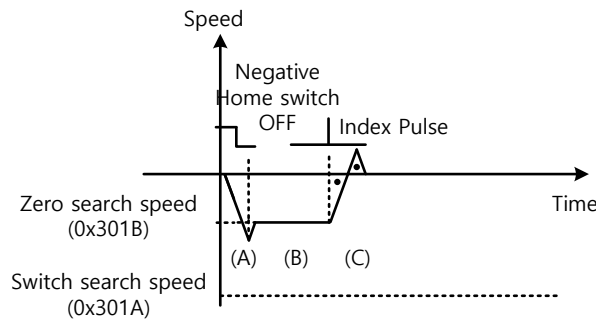

- (A) Since the home signal is on, the drive operates at the switch search speed in the direction of the negative home switch (CW). It may not reach the switch search speed depending on the start position of homing.
- (B) When the home switch is turned off, the drive decelerates to the zero search speed, then continues to operate.
- (C) While operating at zero search speed, the drive detects the first index pulse to move to the index position (Home).

(3) At the start of homing, the home switch is off and the limit is met during operation

**Homing Method ⑭**

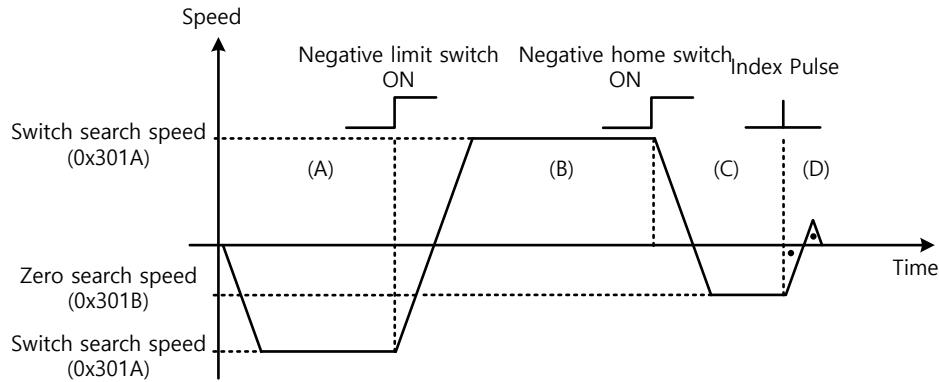

- (A) The initial driving direction is reverse (CW), and the drive operates at the switch search speed.
- (B) When the negative limit switch (NOT) is turned on, the drive decelerates to a stop, then operates at the switch search speed in the forward direction (CCW).
- (C) When the negative home switch is turned on, the drive decelerates to the zero search speed, then switches its direction to the reverse direction (CW).
- (D) While operating at zero search speed, the drive detects the first index pulse to move to the index position (Home).

Methods 11, 12, and 13 are nearly identical to method 14 in terms of homing sequence. The only differences are the initial driving direction and home switch polarity.

**Method 24**

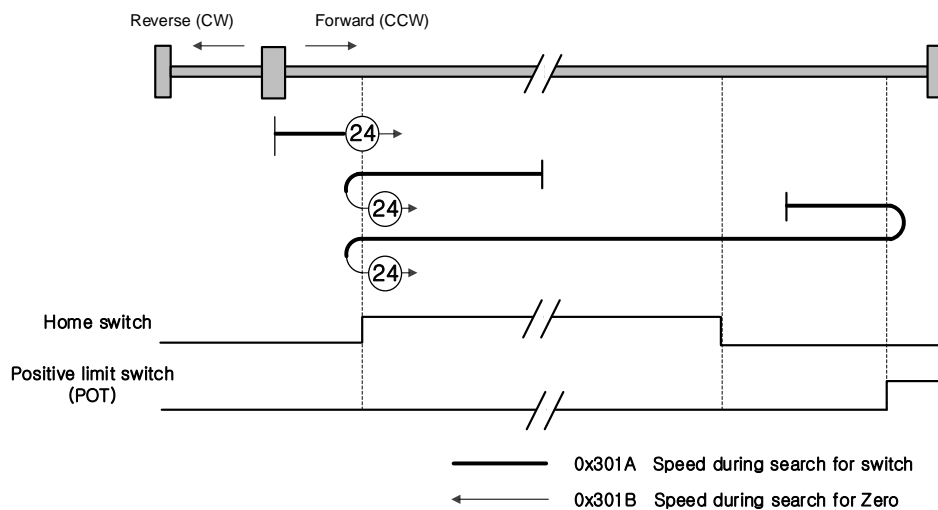

The initial driving direction is forward (CCW), and the point where the positive home switch is turned on becomes the home position.

■ Method 28

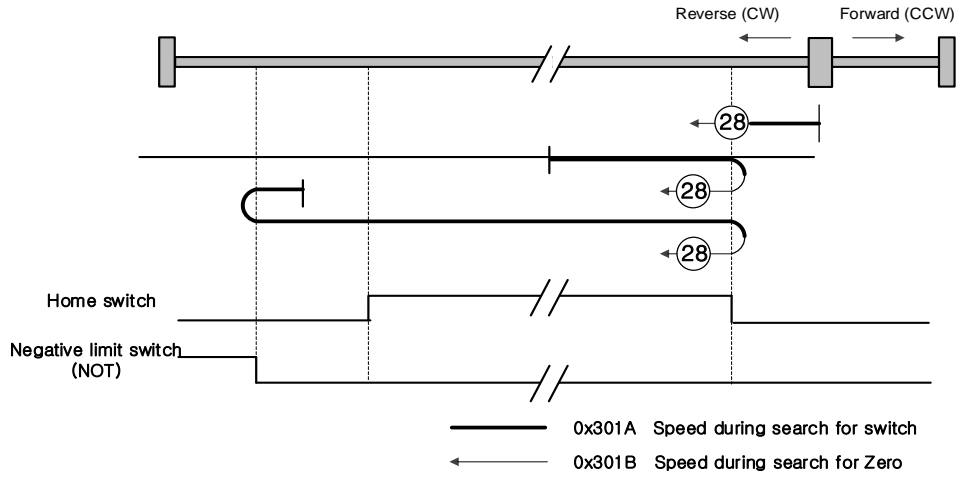

The initial driving direction is reverse (CW), and the point where the negative home switch is turned on becomes the home position.

■ Method 33 and 34

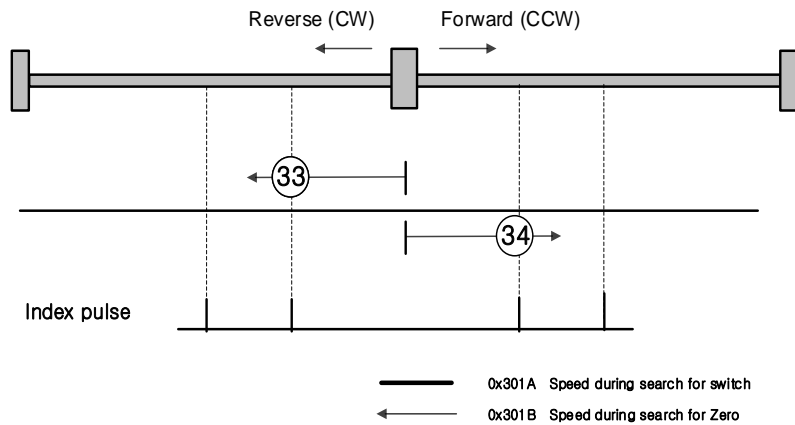

The initial driving direction is reverse (CW) for method 33 and forward (CCW) for method 34. The drive detects the index pulse at the zero search speed.

■ Method 35

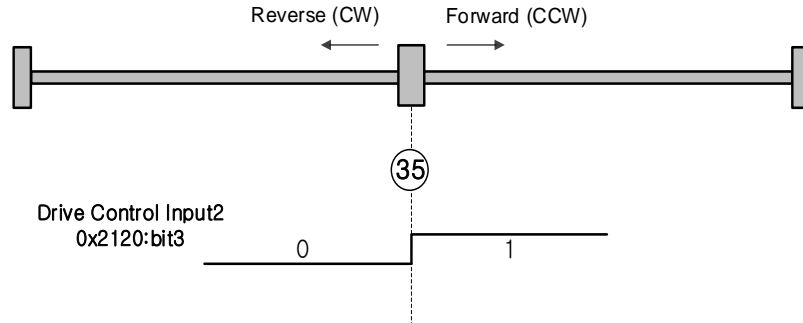

The current position at start of homing operation becomes the home position. This method is used to make the current position the home position according to the demand of the upper level controller.

The drive supports homing methods -1, -2, -3, and -4 apart from the standard ones. These methods can only be used if the home switch is not used separately.

■ Method -1 and -2

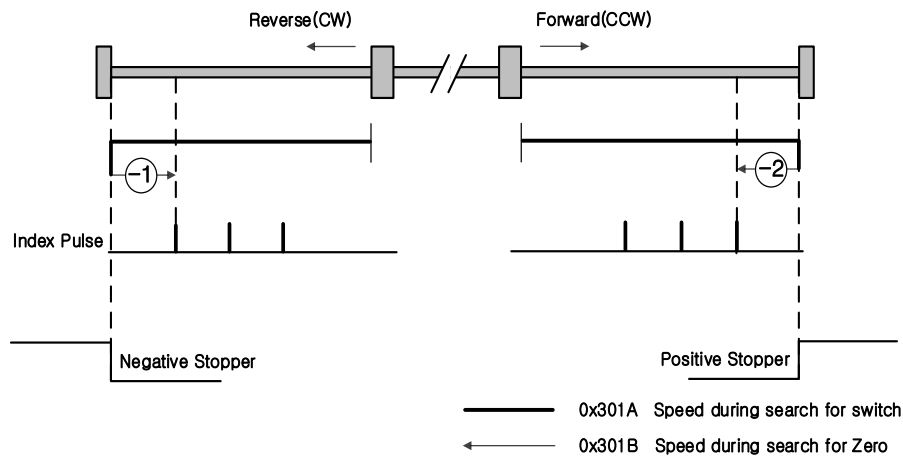

Homing method -1 and -2 perform homing by using the stopper and index (Z) pulse. The velocity profile according to sequence is as follows. For more information, see the details below.

**Homing Method ①**

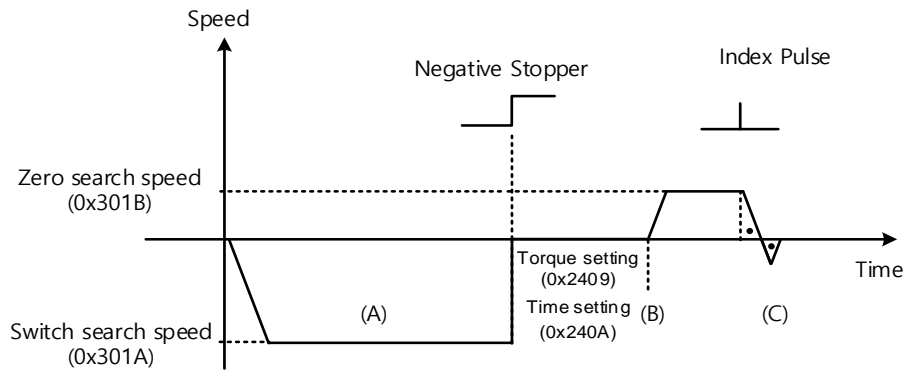

- (A) The initial driving direction is reverse (CW), and the drive operates at the switch search speed.
- (B) When the drive hits the negative stopper, it stands by according to the torque limit value (0x2409) and the time setting value (0x240A) during homing using the stopper, then switches the direction.
- (C) While operating at the zero search speed, the drive detects the first index pulse to move to the index position (Home).

**Homing Method ②**

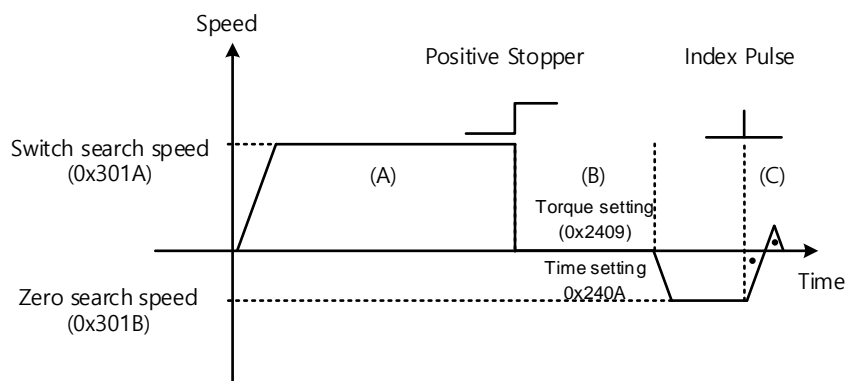

- (A) The initial driving direction is forward (CCW), and the drive operates at the switch search speed.
- (B) When the drive hits the positive stopper, it stands by according to the torque limit value (0x2409) and the time setting value (0x240A) during homing using the stopper, then switches the direction.
- (C) While operating at the zero search speed, the drive detects the first index pulse to move to the index position (Home).

## ■ Method -3 and -4

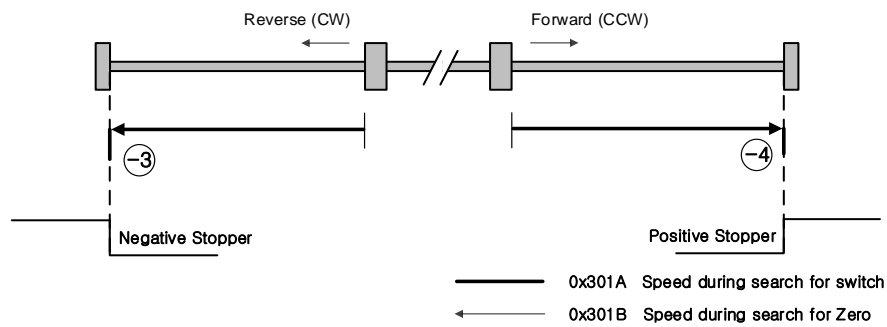

Homing methods -3 and -4 perform homing only by using the stopper. The velocity profile according to sequence is as follows. For more information, see the details below.

### Homing Method ③

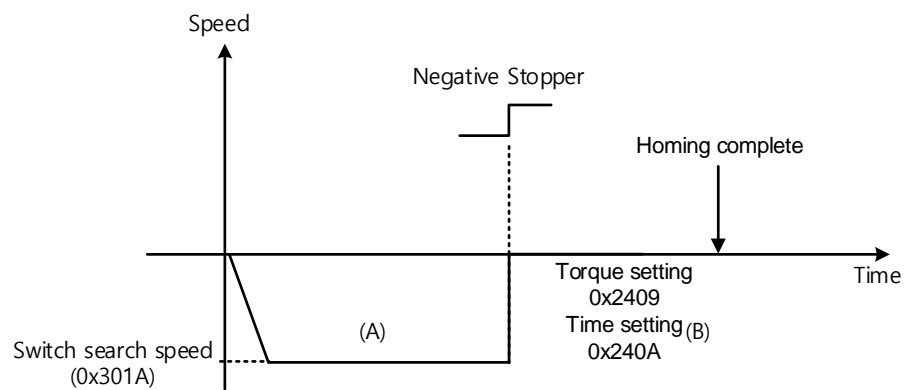

- (A) The initial driving direction is reverse (CW), and the drive operates at the switch search speed.
- (B) When the drive hits the negative stopper, it stands by according to the torque limit value (0x2409) and the time setting value (0x240A) during homing using the stopper, then completes homing.

**Homing Method ④**

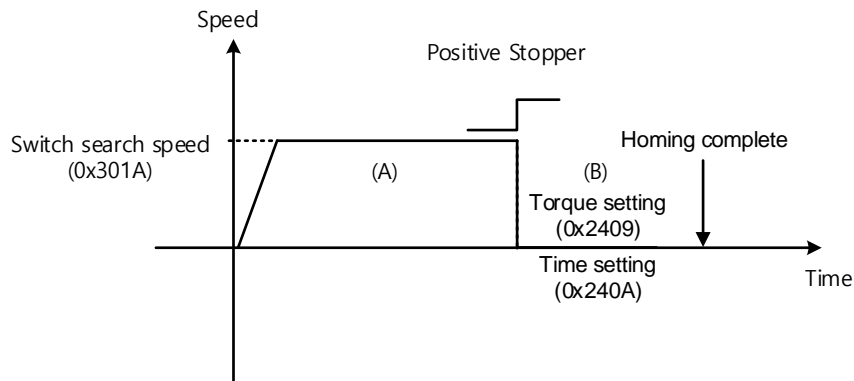

- (A) The initial driving direction is forward (CCW), and the drive operates at the switch search speed.
- (B) When the drive hits the positive stopper, it stands by according to the torque limit value (0x2409) and the time setting value (0x240A) during homing using the stopper, then completes homing.

**■ Method -5 and -6**

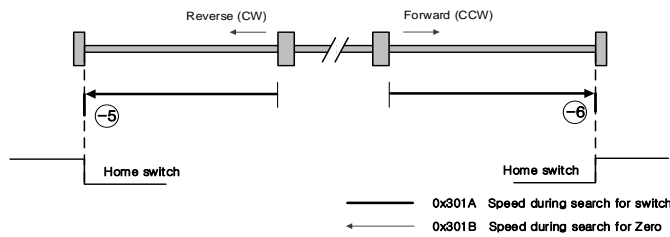

Homing methods -5 and -6 perform homing only by using the stopper. The velocity profile according to sequence is as follows. Homing is stopped when the drive meets the limit switch. For more information, see the details below:

- (1) At the start of homing, the home switch is off and the limit is not met during operation

**Homing Method ⑤**

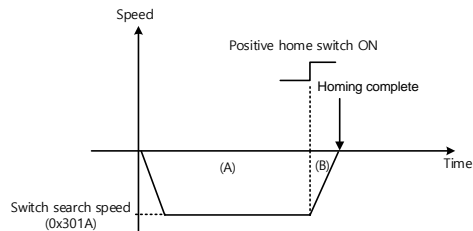

- (A) The initial driving direction is reverse (CW), and the drive operates at the switch search speed.
- (B) If the positive home switch is turned on, the drive decelerates to a stop and completes homing.



- (1) At the start of homing, the home switch is off and the limit is met during operation

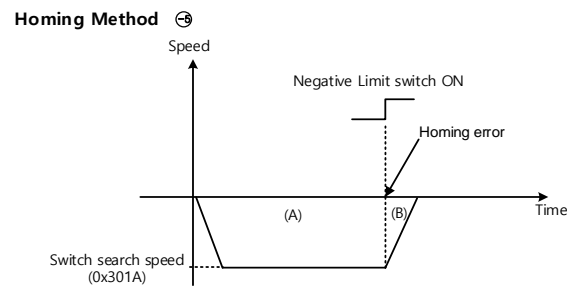

- (A) The initial driving direction is reverse (CW), and the drive operates at the switch search speed.
- (B) When the negative limit switch is turned on, the drive issues a homing error and decelerates to a stop.

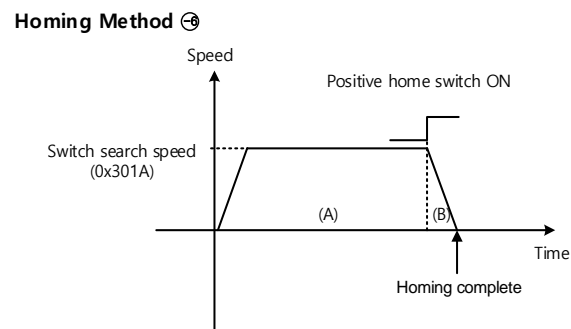

- (A) The initial driving direction is forward (CCW), and the drive operates at the switch search speed.
- (B) If the positive home switch is turned on, the drive decelerates to a stop and completes homing.



# 11. Drive Application Functions

## 11.1 Drive Front Panel

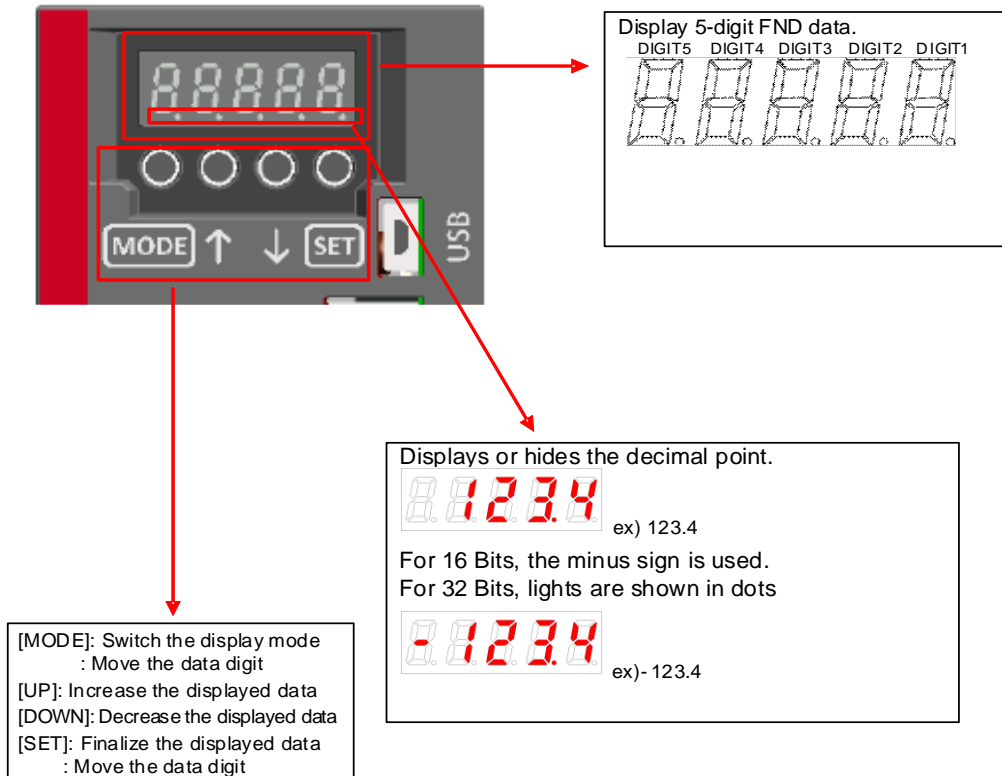

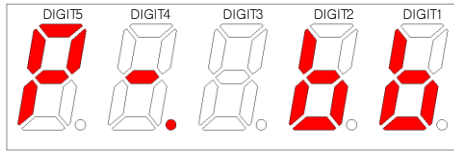

## 11.1.1 7-Segment for Indicating the Servo Status

7-Segment for indicating the servo status consists of 5 digits as shown below, which are in the order of Digit 1→Digit 5 from right to left.

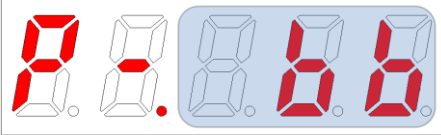
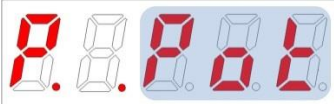
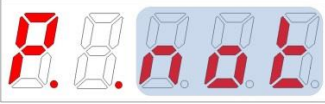
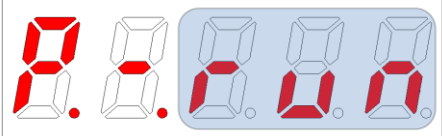

Three digits from Digit 3~1 of the 7-Segment represent the drive status as described below if no servo alarm occurs. In the event of a servo warning occurrence, the warning status display takes precedence over other status.

Digit 3~Digit 1 display	Status details
 <p>Servo OFF</p>	 <p>Positive limit sensor input</p>
 <p>Negative limit sensor input</p>	 <p>Servo ON</p>
 <p>Servo warning W10 occurrence (Code: 10)</p>	

Digit 4 displays the current operation status and servo ready status.

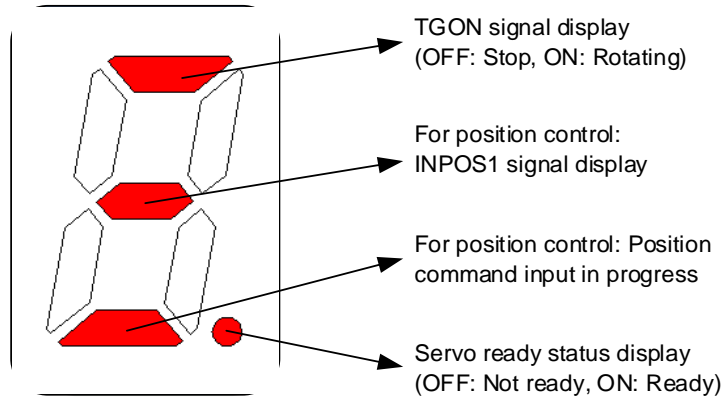



Digit 5 displays the current control mode status and servo on status.

Operation mode and status display		
Position Control Mode: Index , Pulse Input	Homing Mode	(ON: Servo ON)

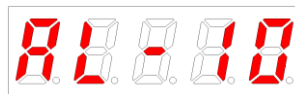
In the event of a servo alarm occurrence, Digit 5~1 blink with the below display. Digit 2 and Digit 1 represent the alarm code. The servo alarm display takes precedence over other status.

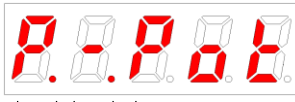

An example of alarm status output  
AL-10 (IPM Fault)

ex. 1) Limit signal input	ex. 2) Servo warning occurrence
 <p>DIGIT3~1: Positive limit input</p> <p>DIGIT4: INPOS1, Servo READY</p> <p>DIGIT5: Position control mode, Servo ON</p>	 <p>DIGIT3~1: W01 (Main power phase loss) + W40 (Low voltage warning) occurred</p> <p>DIGIT4: INSPD, velocity command input in progress, servo READY</p> <p>DIGIT5: Velocity control mode, servo ON</p>

## 11.1.2 Loader Control Method

L7C Series supports the parameters editing by the MODE, UP, DOWN, and SET buttons.

### (1) Parameter Movement

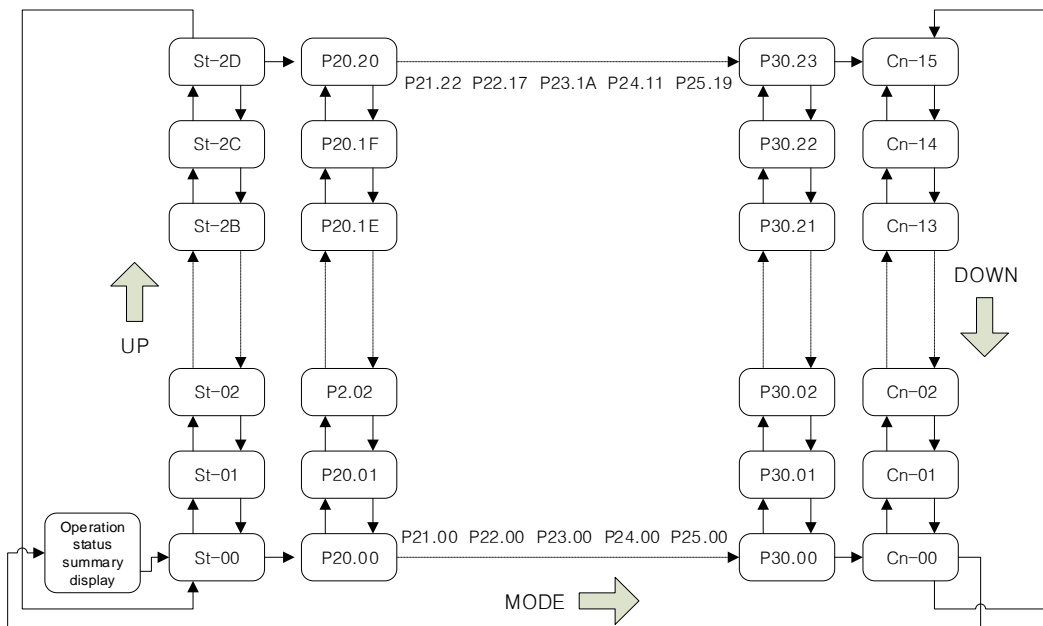

- At the start of operation with no alarm occurrence, the Pulse Input Position Operation Mode [P-.bb] display is shown as the operation status indication.
- Editable parameters are [P20.00]~[Cn-15]. Press [SET] key when a parameter number is displayed, then you can see and edit the parameter data.
- In the initial parameter edit status, the number on the farthest right blinks (ON and OFF for 0.5 seconds each) and becomes editable.

- The parameter number displayed on the Loader window and the one displayed on Drive CM are compatible as shown below.

Loader window display	Drive CM and 「11. Object Dictionary」 Display	
St-00~St-FF	0x2600~0x26FF	
P20.00~P20.FF	0x2000~0x20FF	
P21.00~P21.FF	0x2100~0x21FF	
P22.00~P22.FF	0x2200~0x22FF	
P23.00~P23.FF	0x2300~0x23FF	
P24.00~P24.FF	0x2400~0x24FF	
P25.00~P25.FF	0x2500~0x25FF	
P30.00~P30.FF	0x3000~0x30FF	
Ind00~Ind63	0x3100~0x313F	

**(2)** Example of changing the Velocity Mode to Pulse Input Position Operation Mode  
 ([P30.00]: 00002-> 00001)

Orders	Loader Displays after Control	Keys to Use	What to Do
1			Velocity Control Mode display with the main power and control power applied
2			Press [MODE] to move to [P30.00].
3			Press [SET] to enter the parameter edit window. The displayed parameter is 00002.
4			Press [UP] or [DOWN] at the blinking cursor position to change the number to 00001.
5			Press and hold [SET] for a second. After two blinks, the number 00001 is saved for the parameter.
7			Press and hold [MODE] for a second to return to the [P30.00] parameter.
8			Press [MODE] to change the status to position operation [P= bb], which is the summary display of the current status.

**Note 1)** “” indicates blinking.

If you hold down [UP] or [DOWN] at the current cursor position in the parameter window, the number continues to increase or decrease.



**(3) Example of changing the Speed Loop Integral Time Constant 2([P21.07]: 200 [Ms]-> 500 [Ms])**

Orders	Loader Displays after Control	Keys to Use	What to Do
1			Velocity Control Mode display with the main power applied
2			Press [MODE] to move to [P21.00].
3			Press [UP] or [DOWN] to move to [P21.07].
4			Press [SET] to enter Parameter Edit Mode. The displayed parameter is 00200.
5			Press [/LEFT] or [/RIGHT] at the blinking cursor position to move to the desired digit, DIGIT 3.
6			Press [UP] or [DOWN] at the blinking DIGIT 3 position to change the number to 00500.
7			Press and hold [SET] for a second. After two blinks, the number 00500 is saved for the parameter.
8			Press and hold [MODE] for a second to return to [P21.07].

**Note 1)** " " indicates blinking.

**Note 3)** If you hold down [UP] or [DOWN] at the current cursor position in the parameter window, the number continues to increase or decrease.

## 11.1.3 Control

L7C Series provides the MODE, UP, DOWN, and SET buttons for editing parameters as well as using the operation control parameters provided by L7S Series in the same way.

### 11.1.3.1 Manual JOG Operation [Cn-00]

The drive performs manual JOG operation by itself.

- (1) Press [SET] in [Cn-00] and [JoG] is displayed.

(However, only when EMG, NOT/POT contacts are turned on in the external I/O)

- (2) Press [SET] and [SV-on] is displayed and the servo is turned on for operation.

If an alarm occurs, check wiring and search for other possible causes before restarting.

The loader status display “” means that the external I/O SVON contact is turned on. Try again after turning off the SVON contact.

- (3) While you press and hold [UP], the motor rotates in the forward direction (CCW) at the JOG operation speed of [P23.00].
- (4) While you press and hold [DOWN], the motor rotates in the reverse direction (CW) at the JOG operation speed of [P23.00].
- (5) Press [SET] again to finish the manual JOG operation and turn off the servo.
- (6) Press and hold [MODE] to return to the control parameter screen [Cn-00].

Related Parameters	Velocity	Initial
[P23.00]	Jog operation speed [rpm]	500
[P23.01]	Speed command acceleration time [ms]	200
[P23.02]	Speed command deceleration time [ms]	200
[P23.03]	Speed command S curve time [ms]	0

## [Examples of manual JOG operation control]

Orders	Loader Displays after Control	Keys to Use	What to Do
1			Velocity Control Mode display with the main power applied
2			Press MODE to move to [Cn-00].
3			Press [SET] to enter manual JOG operation.
4			Press [SET] to turn on the servo.
5			Press and hold [UP] while the servo is on and the motor turns in the forward direction (CCW). Take your hand off the key and the motor stops.
6			Press and hold [DOWN] when the servo is on and the motor turns in the reverse direction (CW). Take your hand off the key and the motor stops.
7			Press [DOWN] to switch to the servo off status.
8			Press and hold [MODE] for a second to return to [Cn-00].

※ " " indicates blinking.

### 11.1.3.2 Program JOG Operation [Cn-01]

This is continuous operation according to the predefined program.

- (1) Press [SET] in [Cn-01] parameter to display [P-JoG].
- (2) Press [SET] to display [run]. The program JOG operation starts after the servo is turned on.

(If an alarm occurs at this moment, check the wiring of the servo and search for other possible causes before restarting.)

- (3) Press [SET] again to finish the program JOG operation and turn off the servo.
- (4) Press and hold [MODE] to return to the control parameter screen [Cn-00].
- (5) Four operation steps repeat continuously from 0 to 3. You can set the operation velocity and time in the following parameters.

Related Parameters	Velocity	Initial
[P23.00]	Jog operation speed [rpm]	500
[P23.01]	Speed command acceleration time [ms]	200
[P23.02]	Speed command deceleration time [ms]	200
[P23.03]	Speed command S curve time [ms]	0
[P23.04]	Program Jog Operation Speed 1 [rpm]	0
[P23.05]	Program Jog Operation Speed 2 [rpm]	500
[P23.06]	Program Jog Operation Speed 3 [rpm]	0
[P2.307]	Program Jog Operation Speed 4 [rpm]	-500
[P2.308]	Program jog operation time 1 [ms]	500
[P23.09]	Program jog operation time 2 [ms]	5000
[P23.0A]	Program jog operation time 3 [ms]	500
[P23.0B]	Program jog operation time 4 [ms]	5000

## [Example of program JOG operation control]

Orders	Loader Displays after Control	Keys to Use	What to Do
1			Velocity Control Mode display with the main power and control power applied
2			Press [MODE] to move to [Cn-00].
3			Press [UP] or [DOWN] to move to [Cn-01].
4			Press [SET] to enter program Jog operation.
5			Press [SET] and the motor starts operating according to the predefined program.
6			Press [SET] again to end the continuous operation by the program. [Done] is displayed.
7			Press and hold [MODE] for a second to return to [Cn-01].

※ " " indicates blinking.

### 11.1.3.3 Alarm Reset [Cn-02]

You can reset the alarm that occurred.

- (1) Contact alarm reset: If you turn on A-RST among input contacts, the alarm is reset and the status becomes normal.
- (2) Operation alarm reset: If you press [SET] in the alarm reset [Cn-02] parameter among operation control parameters, [ALrst] is displayed. If you press [SET] again, the alarm is reset and the status becomes normal.

※ If the alarm is maintained after the reset attempt, search for and remove possible causes then repeat the process.

**[Example of alarm reset control]**









Orders	Loader Displays after Control	Keys to Use	What to Do
1			Velocity Control Mode display with the main power applied
2			Press [MODE] to move to [Cn-00].
3			Press [UP] or [DOWN] to move to [Cn-02].
4			Press [SET] to enter the Alarm Reset Mode.
5			Press SET to reset the alarm. [Done] is displayed.
6			Press and hold [MODE] for a second to return to [Cn-02].

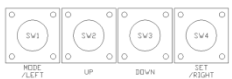
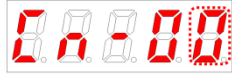

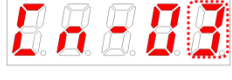
※ " " indicates blinking.

### 11.1.3.4 Reading Alarm History [Cn-03]

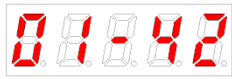
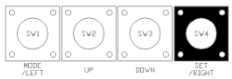
You can view the saved alarm history.

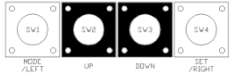
#### [Example of reading alarm history control]

Order	Loader Displays after Control	Keys to Use	What to Do
1			Velocity Control Mode display with the main power applied
2			Press [MODE] to move to [Cn-00].
3			Press [UP] or [DOWN] to move to [Cn-03].
4			Press [SET] to start reading the alarm history.
5			Press [SET] to display the most recent alarm code. ex): Most recent history [AL-42]: Main power phase loss 01: Most recent alarm history 20: 20th previous alarm history
6			Press [UP] or [DOWN] to read the alarm history. ex): second most recent history [AL-10]: overcurrent (HW) 01: Most recent alarm history 20: 20th previous alarm history

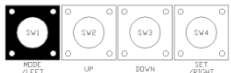
7			<p>Press [SET] to finish reading the alarm history.</p> <p>[Done] is displayed.</p>
8			<p>Press and hold [MODE] for a second to return to [Cn-03].</p>

※ "0" indicates blinking.



### 11.1.3.5 Alarm History Reset [Cn-04]

You can delete all currently stored alarm histories.

#### [Example of alarm history reset control]

Orders	Loader Displays after Control	Keys to Use	What to Do
1			Velocity Control Mode display with the main power and control power applied
2			Press [MODE] to move to [Cn-00].
3			Press [UP] or [DOWN] to move to [Cn-04].
4			Press [SET] to enter alarm history reset.
5			Press [SET] to delete all alarm histories. [Done] is displayed.
6			Press and hold [MODE] for a second to return to [Cn-04].

※ " " indicates blinking.

### 11.1.3.6 Auto Gain Tuning [Cn-05]

You can perform automatic tuning operation.

- (1) Press [SET] in the [Cn-05] parameter to display [Auto].
- (2) Press [SET] to display [run] and start automatic gain tuning.

If an alarm occurs at this moment, check the wiring of the servo and search for other possible causes before restarting.

- (3) Upon completion of gain adjustment, inertia ratio [%] is displayed, and [P21.00], [P21.06] and [P21.08] are automatically changed and saved.

Related Parameters	Name	Initial
[P21.20]	Auto gain tuning velocity [100 RPM]	8
[P21.21]	Auto gain tuning distance	3

## [Example of auto gain tuning control]

Orders	Loader Displays after Control	Keys to Use	What to Do
1			Velocity Control Mode display with the main power and control power applied
2			Press [MODE] to move to [Cn-00].
3			Press [UP] or [DOWN] to move to [Cn-05].
4			Press [SET] to enter automatic gain tuning.
5			Press [SET] to start three cycles of forward rotation and reverse rotation.
6		-	Upon completion of automatic tuning, the tuning result is displayed on the loader.  If you want to perform re-tuning in this state, press [SET].
7			Press and hold [MODE] for a second to return to [Cn-05].

※ " " indicates blinking.

### 11.1.3.7 Phase Z Search Operation [Cn-06]

You can perform phase Z search operation.

- (1) Press [SET] in [Cn-06] to display [Z-rtn].
- (2) Press [SET] to display [run] turn on the servo.
- (3) While you hold down [UP], the motor keeps turning forward (CCW) until it finds the phase Z position of the encoder.
- (4) While you hold down [DOWN], the motor keeps turning in the reverse direction until it finds the phase Z position of the encoder.
- (5) Press [SET] to display [Done] and end the phase Z search.

※ This function is useful for assembly by a specific standard after finding the Z position.

Related Parameter	Name	Initial
[P30.07]	Phase Z search operation velocity setting [RPM]	10

## [Example of phase Z search operation control]

Orders	Loader Displays after Control	Keys to Use	What to Do
1			Velocity Control Mode display with the main power and control power applied
2			Press [MODE] to move to [Cn-00].
3			Press [UP] or [DOWN] to move to [Cn-06].
4			Press [SET] to enter phase Z search operation.
5			Press [SET] to turn on the servo.
6			Press [UP] and the motor turns in the forward direction (CCW) until it finds phase Z. Press [DOWN] and the motor turns in the reverse direction (CW) until it finds phase Z.
7			Press [SET] to end the phase Z search operation mode. The servo is turned off and [Done] is displayed.
8			Press and hold [MODE] for a second to return to [Cn-06].

※ " " indicates blinking.

### 11.1.3.8 Input Contact Forced ON/OFF [Cn-07]

The drive alone forcibly turns on/off the input contact without using an upper level controller or I/O jig.

#### (1) Input Contact Forced ON/OFF Setting

The positions of the 7-segment LEDs and CN1 contacts correspond as follows.

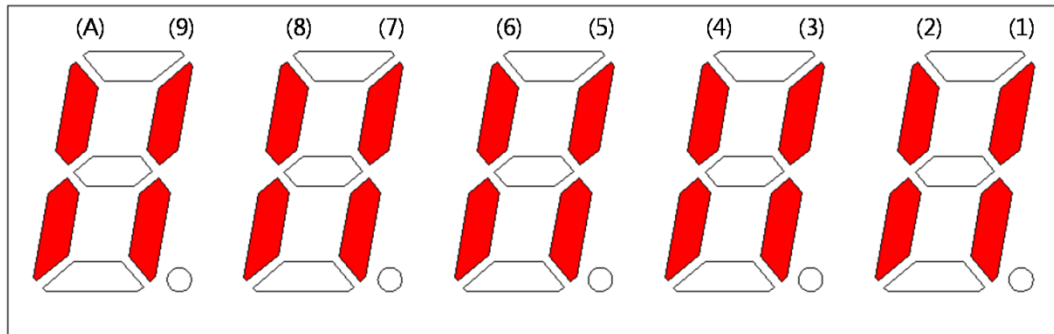

If an LED that corresponds to a contact is turned on/off, it indicates the ON/OFF state of the contact.

#### [Input Contact Setting]

Number	(A)	(9)	(8)	(7)	(6)	(5)	(4)	(3)	(2)	(1)
CN1 □ pin number	48	18	19	20	46	17	21	22	23	47
Default allocated signal name	STOP	EMG	NOT	POT	DIR	A-RST	SPD3	SPD2	SPD1	SVON

Press [UP] on each digit to turn on/off the signals (A), (8), (6), (4) and (2) forcibly.

Press [DOWN] on each digit to turn on/off the signals (9), (7), (5), (3) and (1) forcibly.

Press [MODE] to move to another digit.

#### (2) Example of Forced Input Contact ON/OFF

(SVON ON → EMG ON → EMG OFF → SVON OFF)

## [Example of input contact forced ON/OFF control]

Orders	Loader Displays after Control	Keys to Use	What to Do
1			Press [MODE] to move to [Cn-00].
2			Press [UP] or [DOWN] to move to [Cn-07].
3			Press [SET] to enter the input forced ON/OFF mode.
4			Press [SET] to enter forced input bit setting.
5			Press [DOWN] to turn on the servo forcibly.
6			Press [MODE] at the blinking cursor position to move to the desired digit, DIGIT 5.
7			Press [DOWN] to turn on EMG forcibly.
8			Press [DOWN] to turn off EMG forcibly.
9			Press [MODE] to move the cursor to the desired digit, DIGIT 1.
10			Press [DOWN] to turn off the servo forcibly.
11			Press [SET] to end the input forced ON/OFF mode. [Done] is displayed.
12			Press and hold [MODE] for a second to return to [Cn-07].

※ " " indicates blinking.

### 11.1.3.9 Output Contact Forced ON/OFF [Cn-08]

Without an upper level controller or I/O jig, the drive forcibly turns on/off the output contact.

(1) Output Contact Forced ON/OFF Setting

The positions of the 7-segment LEDs and CN1 contacts correspond as follows.

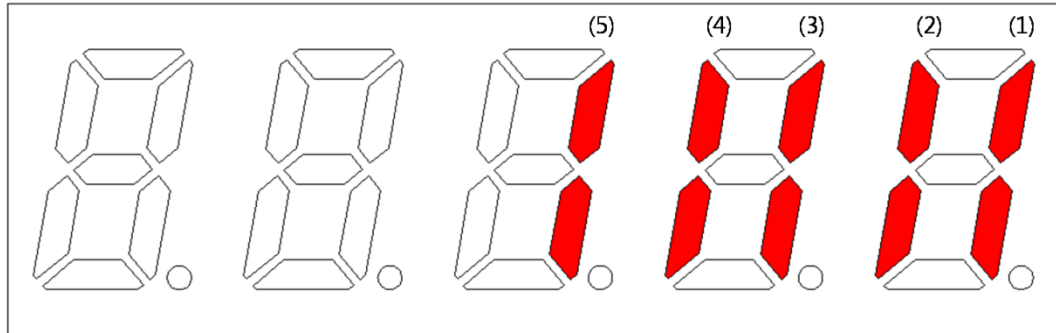

If an LED that corresponds to a contact is turned on/off, it indicates the ON/OFF state of the contact.

**[Output Contact Setting]**

Number	(5)	(4)	(3)	(2)	(1)
CN1- pin number	45	44	43	40/41	38/39
Default allocated signal name	INPOS	BRAKE	ZSPD	READY	ALARM

Press [UP] on each digit to turn on/off forced output of the (4) and (2) signals.

Press [DOWN] on each digit to turn on/off forced output of the (5), (3) and (1) signals.











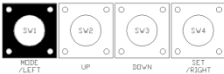
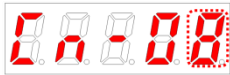
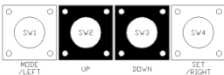

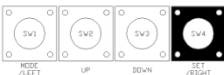
Press [MODE] to move to another digit.

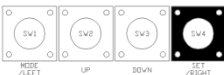
(2) Example of Output Contact Forced ON/OFF

(BRAKE OFF)

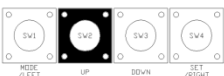

## [Example of output contact forced ON/OFF control]

Orders	Loader Displays after Control	Keys to Use	What to Do
1			Press [MODE] to move to [Cn-00].
2			Press [UP] or [DOWN] to move to [Cn-08].
3			Press [SET] to enter input forced ON/OFF setting.
4			Press [SET] to enter forced output bit setting.
5			Press [MODE] at the blinking cursor to move to the desired digit, DIGIT 2, and initiate rotation.
6			Press [UP] to turn off the brake signal.
7			Press [SET] to end the input forced ON/OFF mode. [Done] is displayed.
8			Press and hold [MODE] for a second to return to [Cn-08].

※ " " indicates blinking.

### 11.1.3.10 Parameter Reset [Cn-09]

You can reset the parameter data.

**[Example of parameter reset control]**

Orders	Loader Displays after Control	Keys to Use	What to Do
1			Velocity Control Mode display with the main power and control power applied
2			Press [MODE] to move to [Cn-00].
3			Press [UP] or [DOWN] to move to [Cn-09].
4			Press [SET] to enter parameter reset.
5			Press [SET] to reset data. [Done] is displayed.
6			Press and hold [MODE] for a second to return to [Cn-09].

[Parameters not applicable in Cn-09 parameter reset]

- Current offset parameters are not reset.
- Alarm offset parameters are not reset.
- Index parameters are not reset.

Use the default set in Object Dictionary of Drive CM to reset index parameters.

※ " " indicates blinking.

### 11.1.3.11 Automatic Velocity Command Offset Correction [Cn-10]

The offset value of analog velocity commands can be corrected automatically.

The range of adjustable velocity command analog voltage is from +1V to -1V. If the offset voltage is out of this range, [oVrnG] is displayed and no correction takes place.

The corrected offset value can be viewed in [P22.18] analog velocity offset.

#### [Example of automatic velocity command offset correction]

Orders	Loader Displays after Control	Keys to Use	What to Do
1			Press [MODE] to display [Cn-00].
2			Press [UP] or [DOWN] to move to [Cn-10].
3			Press [SET] to enter offset correction.
4	or 		Press [SET] to start offset correction. [Done] is displayed. If the value is out of the allowed range, [oVrnG] is displayed.
5			Press and hold [MODE] for a second to return to [Cn-10].

※ " " indicates blinking.

### 11.1.3.12 Automatic Torque Command Offset Correction [Cn-11]

The offset value of analog torque commands can be corrected automatically.

The range of adjustable torque command analog voltage is from +1V to -1V. If the offset voltage is out of this range, [oVrnG] is displayed and no correction takes place.

You can check the corrected offset value in analog torque offset [P20.21].

**[Example of automatic torque command offset correction]**

Orders	Loader Displays after Control	Keys to Use	What to Do
1			Press [MODE] to display [Cn-00].
2			Press [UP] or [DOWN] to move to [Cn-11].
3			Press [SET] to enter offset correction.
4	 or 		Press [SET] to start offset correction. [Done] is displayed. If the value is out of the allowed range, [oVrnG] is displayed.
5			Press and hold [MODE] for a second to return to [Cn-11].

※ "0" indicates blinking.

### 11.1.3.13 Manual Velocity Command Offset Correction [Cn-12]

You can correct the offset value of analog velocity commands manually. Control example (-10)

The range of adjustable velocity command analog voltage is from +1V to -1V. If the offset voltage goes out of this range, [oVrnG] OverRange is displayed and no compensation takes place.

You can check the corrected offset value in the analog velocity offset [P20.18].

#### [Example of manual velocity command offset correction]

Orders	Loader Displays after Control	Keys to Use	What to Do
1			Press [MODE] to display [Cn-00].
2			Press [UP] or [DOWN] to move to [Cn-12].
3			Press [SET] to enter offset correction.
4			Press [SET] to enter offset correction setting. The current offset value is displayed.
5			Press [UP] or [DOWN] to make adjustment to the desired value.
6		 or 	Press [SET] to save the adjusted offset value. [Done] is displayed. Press [MODE] not to save the value.
7			Press and hold [MODE] for a second to return to [Cn-12].

※ " " indicates blinking.

### 11.1.3.14 Manual Torque Command Offset Correction [Cn-13]

You can correct the offset value of analog torque commands manually.

The range of adjustable torque command analog voltage is from +1V to -1V. If the offset voltage is out of this range, [oVrnG] is displayed and no correction takes place.

You can check the corrected offset value in the analog torque command offset [P20.21].

**[Example of manual torque command offset correction control]**







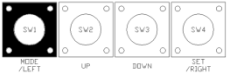
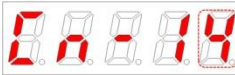

Orders	Loader Displays after Control	Keys to Use	What to Do
1			Press [MODE] to display [Cn-00].
2			Press [UP] or [DOWN] to move to [Cn-13].
3			Press [SET] to enter offset correction.
4			Press [SET] to enter offset correction setting. The current offset value is displayed.
5			Press [UP] or [DOWN] to make adjustment to the desired value.
6		 or 	Press [SET] to save the adjusted offset value. [Done] is displayed. Press [MODE] not to save the value.
7			Press and hold [MODE] for a second to return to [Cn-13].

※ "0" indicates blinking.

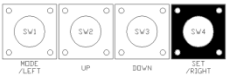
### 11.1.3.15 Absolute Encoder Value Reset [Cn-14]

You can reset the encoder multi-turn data to 0.

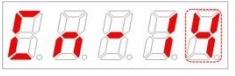
[Example of absolute encoder reset control]

Orders	Loader Displays after Control	Keys to Use	What to Do
1			Press [MODE] to display [Cn-00].
2			Press [UP] or [DOWN] to move to [Cn-14].
3			Press [SET] to enter encoder reset.
4		 or 	Press [SET] to reset the absolute encoder multi-turn data. [Done] is displayed. Press [MODE] not to perform reset.
7			Press and hold [MODE] for a second to return to [Cn-14].

※ " " indicates blinking.

※ After you reset the absolute encoder value, you can view the reset value in [st-18].

### 11.1.3.16 Instantaneous Maximum Load Factor Reset [Cn-15]

You can reset the instantaneous maximum load factor to 0.

[Example of instantaneous maximum load factor control]

Orders	Loader Displays after Control	Keys to Use	What to Do
1			Press [MODE] to display [Cn-00].
2			Press [UP] or [DOWN] to move to [Cn-15].
3			Press [SET] to enter the instantaneous maximum load factor reset.
4			Press [SET] to display the current maximum load factor.
5	or 		Press [UP] to display the forward maximum load factor. Press [DOWN] to display the reverse maximum load factor.
6		 or 	Press [SET] to reset the instantaneous maximum load factor. [Done] is displayed. Press [MODE] not to perform reset.
7			Press and hold [MODE] for a second to return to [Cn-15].







※ " " indicates blinking.

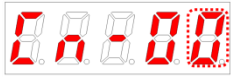
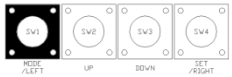
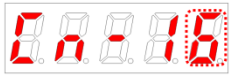

### 11.1.3.17 Parameter Lock [Cn-16]

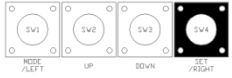
You can enable the parameter lock.

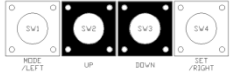
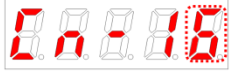
#### [Example of parameter lock setting control]









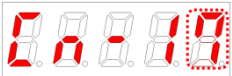

Orders	Loader Displays after Control	Keys to Use	What to Do
1			Press [MODE] to display [Cn-00].
2			Press [UP] or [DOWN] to move to [Cn-16].
3			Press [SET] to enter parameter lock.
4	or  		Press [UP] to disable the parameter lock.  Press [DOWN] to enable the parameter lock.
5			Press and hold [MODE] for a second to return to [Cn-16].

※ " " indicates blinking.

### 11.1.3.18 Current Offset [Cn-17]

You can save the current offset value to parameters [P20.15]~[P20.17].

**[Example of current offset value control]**

Orders	Loader Displays after Control	Keys to Use	What to Do
1			Press [MODE] to display [Cn-00].
2			Press [UP] or [DOWN] to move to [Cn-17].
3			Press the SET key to enter the state of current offset setting.
6			Press [SET] to save the phase U current offset value in [P20.15] and the phase V current offset value in [P20.16].
7			Press and hold [MODE] for a second to return to [Cn-17].

※ "  " indicates blinking.

## 11.2 Input/Output Signals Setting

### 11.2.1 Assignment of Digital Input Signals

You can set the functions of CN1 connector's digital input signals and the input signal level. As shown in the figure below, you can assign input functions to use out of the 30 functions to the digital input signals 1-16.

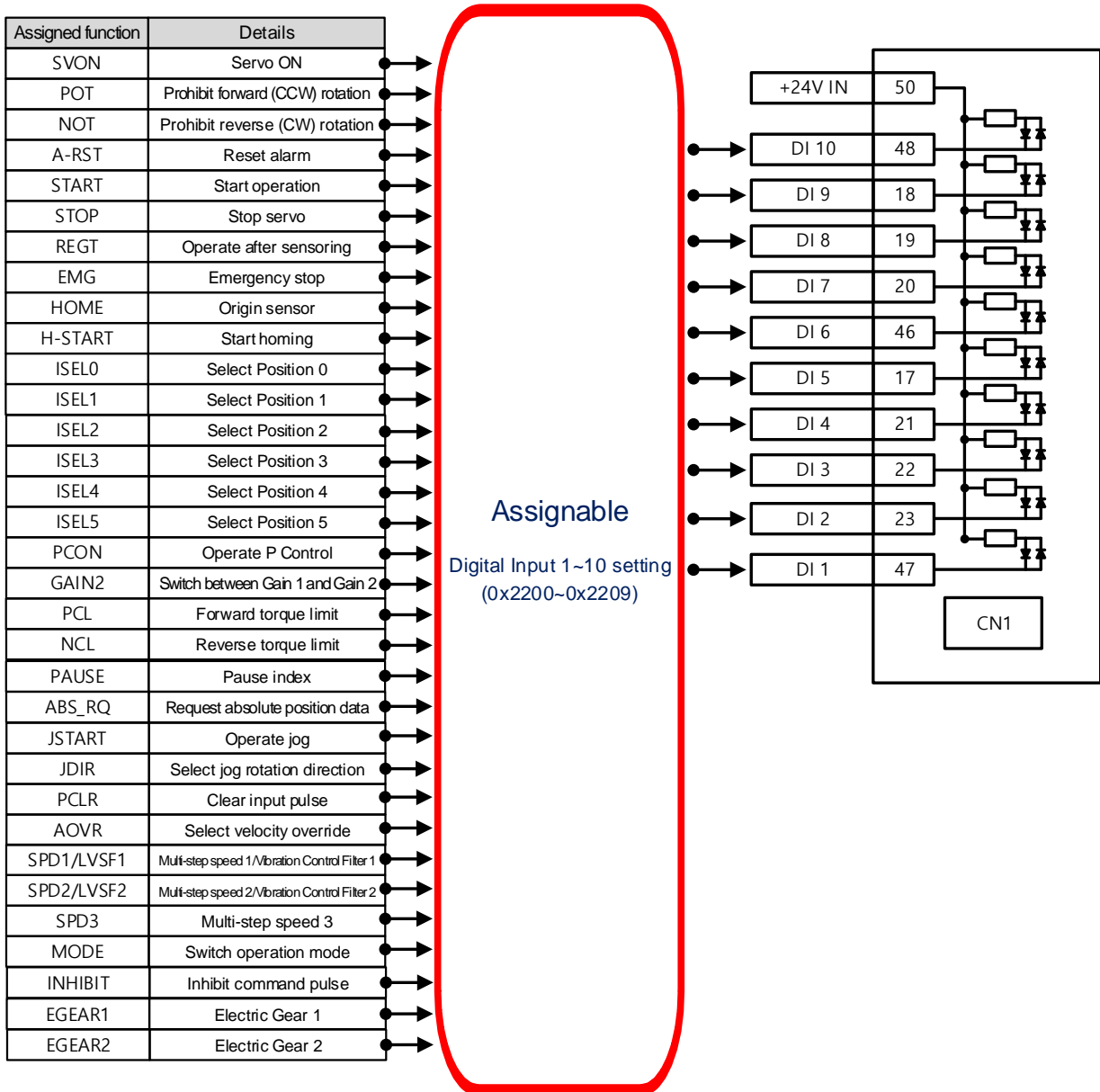

**■ Related Objects**

Index	Sub Index	Names	Variable Type	Accessibility	PDO Assignment	Unit
0x2200	-	Digital Input Signal 1 Selection	UINT	RW		-
0x2201	-	Digital Input Signal 2 Selection	UINT	RW		-
0x2202	-	Digital Input Signal 3 Selection	UINT	RW		-
0x2203	-	Digital Input Signal 4 Selection	UINT	RW		-
0x2204	-	Digital Input Signal 5 Selection	UINT	RW		-
0x2205	-	Digital Input Signal 6 Selection	UINT	RW		-
0x2206	-	Digital Input Signal 7 Selection	UINT	RW		-
0x2207	-	Digital Input Signal 8 Selection	UINT	RW		-
0x2208	-	Digital Input Signal 9 Selection	UINT	RW		-
0x2209	-	Digital Input Signal 10 Selection	UINT	RW		-

Bit	Setting Details
15	Signal input level settings (0: contact A, 1: contact B)
14~8	Reserved
7~0	Assign input signal.

Set the functions of CN1 connector's digital input signals and the input signal level. Select signals to assign to bits 7~0, and set the signal level to bit 15.

Setting ex) If the setting value is 0x0006

0	0	0	6
Contact A		GAIN2 assigned	

Contact A: The default status is 1 (High).  
Input 0 (Low) to actuate it (Active Low).

Contact B: The default status is 0 (Low).  
Input 1 (High) to activate it (Active High).

Setting values	Assigned signals
0x00	Not assigned
0x01	POT
0x02	NOT
0x03	HOME
0x04	STOP
0x05	PCON
0x06	GAIN2
0x07	P_CL
0x08	N_CL
0x09	Reserved
0x0A	Reserved
0x0B	EMG
0x0C	A_RST
0x0F	SV_ON
0x10	START
0x11	PAUSE
0x12	REGT
0x13	HSTART
0x14	ISEL0
0x15	ISEL1
0x16	ISEL2
0x17	ISEL3
0x18	ISEL4
0x19	ISEL5
0x1A	ABSRQ
0x1B	JSTART
0x1C	JDIR
0x1D	PCLR
0x1E	AOVR
0x20	SPD1/LVSF1
0x21	SPD2/LVSF2
0x22	SPD3
0x23	MODE
0x24	EGEAR1
0x25	EGEAR2
0x26	ABS_RESET

■ Example of Digital Input Signal Assignment

The following table shows an example of assigning input signals. See the setting values for parameters 0x2200~0x2209.

DI 1	DI 2	DI 3	DI 4	DI 5	DI 6	DI 7	DI 8
SV_ON (Contact A)	SPD1 (Contact A)	SPD2 (Contact A)	SPD3 (Contact A)	A-RST (Contact A)	JDIR (Contact A)	NOT (Contact A)	POT (Contact A)
DI 9	DI 0A						
EMG (Contact A)	STOP (Contact A)						

I/O (Pin number)	Setting parameter	Bit		Setting value	Details
		15	7-0		
DI # 1 (47)	0x2200	0	0x0F	0x000F	SV_ON (Contact A)
DI # 2 (23)	0x2201	0	0x20	0x0020	SPD1 (Contact A)
DI # 3 (22)	0x2202	0	0x21	0x0021	SPD2 (Contact A)
DI # 4 (21)	0x2203	0	0x22	0x0022	SPD3 (Contact A)
DI # 5 (17)	0x2204	0	0x0C	0x000C	A-RST (Contact A)
DI # 6 (46)	0x2205	0	0x1C	0x001C	JDIR (Contact A)
DI # 7 (20)	0x2206	0	0x01	0x0001	NOT (Contact A)
DI # 8 (19)	0x2207	0	0x02	0x0002	POT (Contact A)
DI # 9 (18)	0x2208	0	0x0B	0x000B	EMG (Contact A)
DI # 10 (48)	0x2209	0	0x04	0x0004	STOP (Contact A)

## 11.2.2 Digital Output Signal Assignment

You can set the functions of CN1 connector's digital output signals and the output signal level. As shown in the figure below, you can assign output functions to use out of the 19 functions to the digital input signals 1~5. Keep in mind that the digital output signals 6~8 are locked for alarm output (assignment not available).

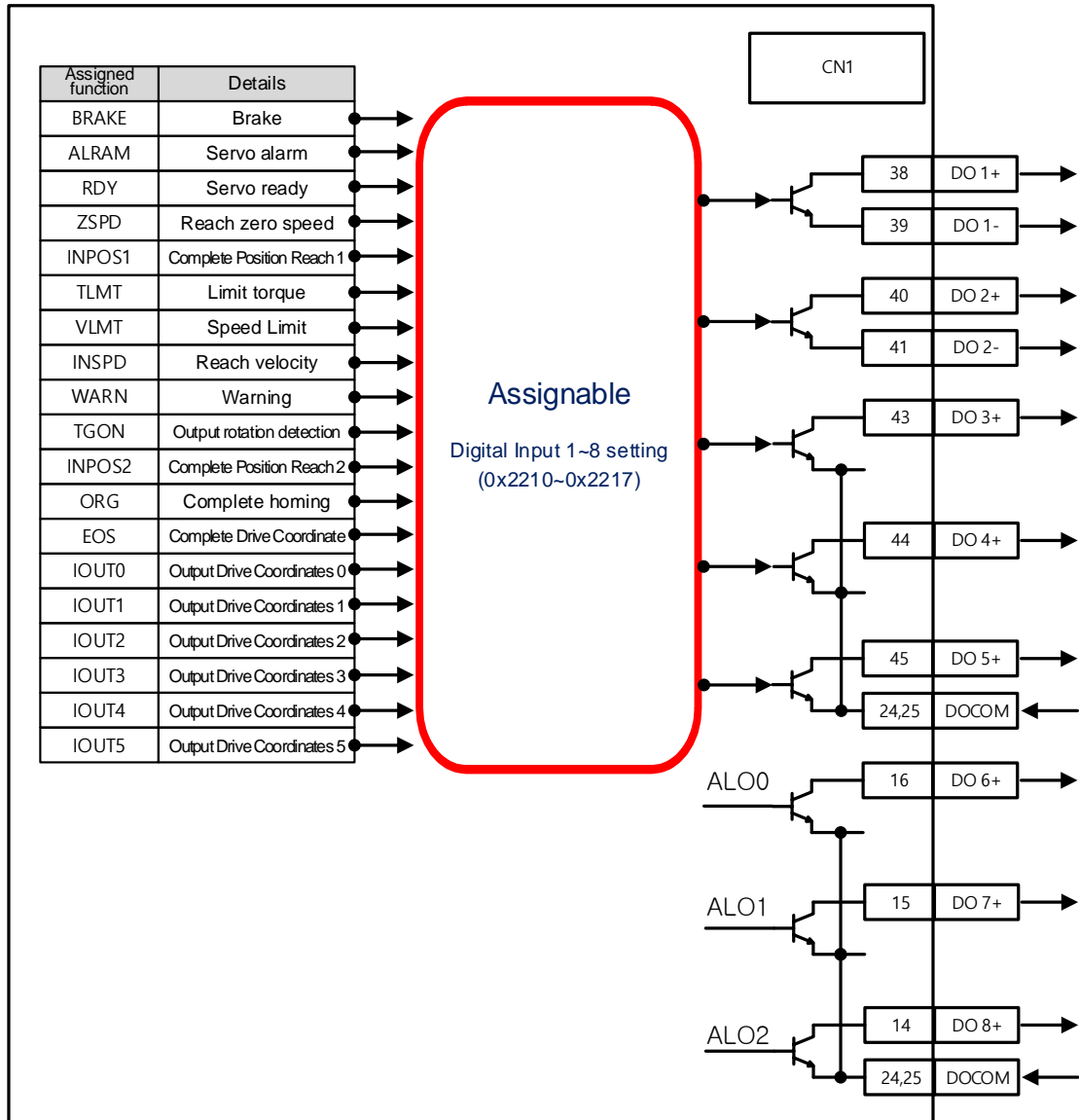

■ Related Objects

Index	Sub Index	Names	Variable Types	Access ibility	PDO Assignment	Unit
0x220A	-	Digital Output Signal 1 Selection	UINT	RW		-
0x220B	-	Digital Output Signal 2 Selection	UINT	RW		-
0x220C	-	Digital Output Signal 3 Selection	UINT	RW		-
0x220D	-	Digital Output Signal 4 Selection	UINT	RW		-
0x220E	-	Digital Output Signal 5 Selection	UINT	RW		-

Assign the functions of CN1 connector's digital output signal and set the output signal level. Select signals to assign to bits 7~0, and set the signal level to bit 15.

Bits	Setting Details
15	Signal output level settings (0: contact A, 1: contact B)
14~8	Reserved
7~0	Output signal assignment

Setting Values	Assignable output signals
0x00	Not assigned
0x01	BRAKE
0x02	ALARM
0x03	RDY
0x04	ZSPD
0x05	INPOS1
0x06	TLMT
0x07	VLMT
0x08	INSPD
0x09	WARN
0x0A	TGON
0x0B	INPOS2
0x10	ORG
0x11	EOS
0x12	IOUT0
0x13	IOUT1
0x14	IOUT2
0x15	IOUT3
0x16	IOUT4
0x17	IOUT5



## ■ Example Digital Output Signal Assignment

The following table shows an example of assigning output signals. See the setting values for parameters 0x220A~0x220E.

DO#1	DO#2	DO#3	DO#4	DO#5
ALARM (Contact B)	RDY (Contact A)	ZSPD (Contact A)	BRAKE (Contact B)	INPOS1 (Contact A)

CN1 (Pin number)	Setting Parameter	Bit		Setting Value	Details
		15	7~0		
DO # 1 (38,39)	0x220A	1	0x02	0x8002	ALARM(Contact B)
DO # 2 (40,41)	0x220B	0	0x03	0x0003	RDY(Contact A)
DO # 3 (43)	0x220C	0	0x04	0x0004	ZSPD(Contact A)
DO # 4 (44)	0x220D	1	0x01	0x8001	BRAKE(Contact B)
DO # 5 (45)	0x220E	0	0x05	0x0005	INPOS1(Contact A)

## 11.3 Electric Gear Setup

### 11.3.1 Indexing Position Operation Electric Gear

This function allows you to drive the motor by the user unit in which the user intends to give commands.

The electric gear function of the drive does not allow the user to utilize the highest resolution of the encoder. If the upper level controller has the function of electric gear, it is advisable to use it instead.

Set the gear ratio within the range of 1000-1/1000.

When using the electric gear and the STOP signal at the same time, adjust the value of Quick Stop Deceleration [0x3024] to set the method you desire to use.

Typically, electric gears are used in the following situations.

**(1) To drive the load based on user unit**

**[UU] = Unit used by the user**

You can see the [UU] settings in the index parameter settings for index operation.

	Index 0
Index Type	Relative
Distance [UU]	524288
Velocity [UU/s]	262144
Acceleration [UU/s <sup>2</sup> ]	262144
Deceleration [UU/s <sup>2</sup> ]	262144
Registration Distance [UU]	0
Registration Velocity [UU/s]	0
Repeat Count	0
Dwell Time [ms]	Wait for Start
Next Index	Wait for Start
Action	Copy Paste

If gear ratio is not used, [UU] in the index is converted to [Pulses].

**[UU] = [Pulses]**

For example, to make 1 [turn] of a motor with a 19 [bit] resolution encoder attached, you need to input 524288 [Pulses], which is equivalent to 19 [bits].

	Index 0
Index Type	Relative
Distance [UU]	524288
Velocity [UU/s]	262144
Acceleration [UU/s <sup>2</sup> ]	262144
Deceleration [UU/s <sup>2</sup> ]	262144
Registration Distance [UU]	0
Registration Velocity [UU/s]	0
Repeat Count	0
Dwell Time [ms]	Wait for Start
Next Index	Wait for Start
Action	Copy Paste

Resolution 524288[ppr] = 19[Bit]



In this case, it is straightforward to enter a distance value to make 1 [turn] of a motor.

**a. Necessity to apply gear ratio when setting a custom position unit**

If a ball screw linear motor which moves 1 [mm] per 1 [turn] has been attached to the user's 19 [bit] motor, you need to enter "524288" for Distance [UU] in order to move the linear motor by 1 [mm].

Index 0	
Index Type	Relative
Distance [UU]	524288
Velocity [UU/s]	262144
Acceleration [UU/s <sup>2</sup> ]	262144
Deceleration [UU/s <sup>2</sup> ]	262144
Registration Distance [UU]	0
Registration Velocity [UU/s]	0
Repeat Count	0
Dwell Time [ms]	Wait for Start
Next Index	
Action	Copy Paste

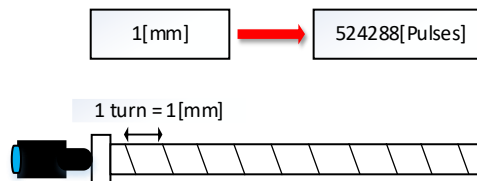

To move it by 10 [mm], you need to input "5242880."

Index 0	
Index Type	Relative
Distance [UU]	5242880
Velocity [UU/s]	262144
Acceleration [UU/s <sup>2</sup> ]	262144
Deceleration [UU/s <sup>2</sup> ]	262144
Registration Distance [UU]	0
Registration Velocity [UU/s]	0
Repeat Count	0
Dwell Time [ms]	Wait for Start
Next Index	
Action	Copy Paste

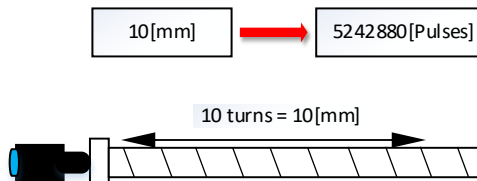

As you can see, movements by short distance like 1 [mm] and 10 [mm] can be made intuitively.

However, to move the motor 5621 [mm], for example, we need a calculation.

$$5621[mm] = 5621[turn] = 5621[turn] \times 524288[Pulses] = 2947022848[Pulses]$$

For the linear motor to move 5621 [mm], the motor needs to make 5621 [turns].

Since 1 [turn] requires 524288 [pulses], we need to enter 2947255848 [pulses] to make 5621 [turns].

Index 0	
Index Type	Relative
Distance [UU]	2947022848
Velocity [UU/s]	262144
Acceleration [UU/s <sup>2</sup> ]	262144
Deceleration [UU/s <sup>2</sup> ]	262144
Registration Distance [UU]	0
Registration Velocity [UU/s]	1000000
Repeat Count	1
Dwell Time [ms]	0
Next Index	Wait for Start
Action	

5621 [mm] → 2947022848 [Pulses]

5621 turns = 5621 [mm]

Not only has the calculation become more complex, but also the value is out of the available distance input range.

$$[\text{UU}] = [\text{Pulses}]$$

The difficulty here is due to the fact that the linear motor's unit [mm] and the 19 [bit] motor's unit [Pulses] are different, making conversion necessary.

$$[\text{UU}] \Rightarrow [\text{Pulses}] \Rightarrow [\text{mm}]$$

To make the process easier, the [UU] can be changed from [Pulses] to [mm]. This is where gear ratio becomes necessary.

**b. Necessity to apply gear ratio when setting a custom speed unit**

$$[\text{UU}/\text{sec}] = [\text{Pulses}/\text{sec}]$$

When gear ratio is not used, the index speed unit is [Pulses/sec].

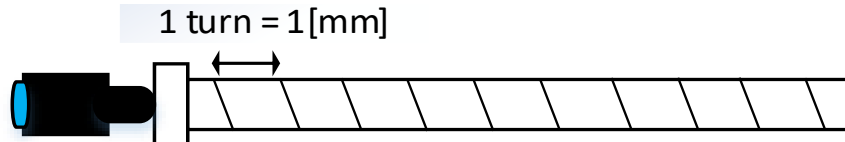

Let's assume that you have set up a ball screw linear motor that moves 1 [mm] per 1 [turn] on the rotary motor attached with the 19 [bit] encoder.

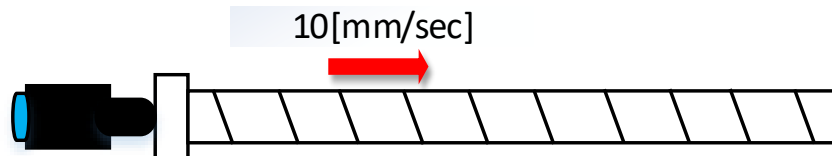

If you want the linear motor to move at a speed of 10 [mm] per second, you can calculate the index speed value as follows.

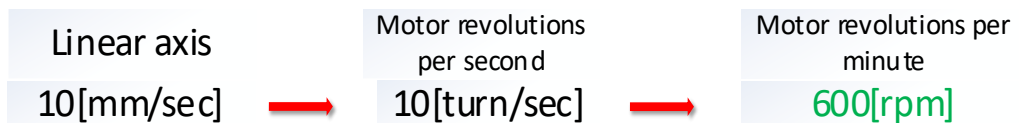

For the linear motor to move 10 [mm] per second, the motor needs to make 10 [turns] per second. For the motor to make 10 [turns] per second, the rotation frequency needs to be 600 [rpm].

$$60 [\text{rpm}] : 524288 [\text{ppr}] = 600 [\text{rpm}] : X [\text{pulses}/\text{sec}]$$

Thus, if the motor rotates at a speed of 600[rpm], the linear motor operates at 10 [mm/sec]. However, since the unit of index velocity is [pulses/sec], it is necessary to obtain the number of pulses per second X using the above proportional expression. Calculation yields 5242880 [pulses/sec]. If you input this value for velocity, the motor runs at 600 [rpm].

Index 0	
Index Type	Relative
Distance [UU]	5621
Velocity [UU/s]	5242880
Acceleration [UU/s <sup>2</sup> ]	10
Deceleration [UU/s <sup>2</sup> ]	10
Registration Distance [UU]	0
Registration Velocity [UU/s]	1000000
Repeat Count	1
Dwell Time [ms]	0
Next Index	Stop
Action	Copy Paste

As you can see, it is quite complicated to convert the linear motor's speed in [mm/sec] into the rotary motor's unit [Pulses/sec].

$$[\text{UU/sec}] = [\text{Pulses/sec}]$$

To make the process easier, it is necessary to change [Pulses/sec] to the linear motor's unit [mm/sec].

$$[\text{UU/sec}] \Rightarrow [\text{Pulses/sec}] \Rightarrow [\text{mm/sec}]$$

**c. How to apply gear ratio**

0x300C	0x0	Electric Gear Numerator 1	1	1	UDINT	rw	1	2147483647
0x300D	0x0	Electric Gear Numerator 2	1	1	UDINT	rw	1	2147483647
0x300E	0x0	Electric Gear Numerator 3	1	1	UDINT	rw	1	2147483647
0x300F	0x0	Electric Gear Numerator 4	1	1	UDINT	rw	1	2147483647
0x3010	0x0	Electric Gear Denomiator 1	1	1	UDINT	rw	1	2147483647
0x3011	0x0	Electric Gear Denomiator 2	1	1	UDINT	rw	1	2147483647
0x3012	0x0	Electric Gear Denomiator 3	1	1	UDINT	rw	1	2147483647
0x3013	0x0	Electric Gear Denomiator 4	1	1	UDINT	rw	1	2147483647
0x3014	0x0	Electric Gear Mode	0	0	UINT	rw	0	1

There are four available electric gears, and you can select one of them to use.

When gear ratio is applied, the servo uses the index distance and gear ratio to automatically calculate the internal command pulse in [Pulses].

$$Index\ Distance\ [UU] \times \frac{Electric\ Gear\ Numerator\ X}{Electric\ Gear\ Denomiator\ X} = Internal\ command\ pulse[Pulses]$$

The servo runs the motor as per the number of internal command pulses.

Let's look at an example of ball screw linear motor that moves 1 [mm] per 1 [turn].

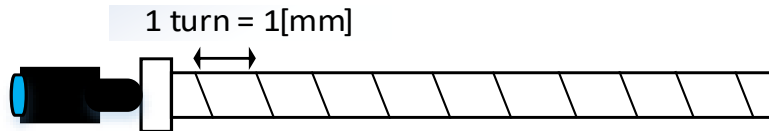

If you want to move the linear motor 1 [mm] by entering 1 into Index Distance, you can enter 524288 for encoder resolution into Gear Numerator 1 [0x300C] and 1 into Electric Gear Denomiator 1 [0x3010].

0x300C	0x0	Electric Gear Numerator 1	524288	1	UDINT	rw	1	2147483647
0x3010	0x0	Electric Gear Denomiator 1	1	1	UDINT	rw	1	2147483647

If you set the gear ratio like above, the internal command pulse can be calculated as follows.

$$Index\ Distance[UU] \times \frac{524288}{1} = Internal\ command\ pulse[Pulses]$$



If you enter 1 for Index Distance,

Index Type	Relative
Distance [UU]	1

$$1[UU] \times \frac{524288}{1} = 524288[\text{Pulses}]$$

an internal command pulse of 524288 [Pulses] is automatically yielded. The servo completes 1 [turn] of the motor in proportion to the pulse value 524288 [Pulses]. If the motor makes 1 [turn], the linear motor moves 1 [mm].

Index Type	Relative
Distance [UU]	1

 Same units

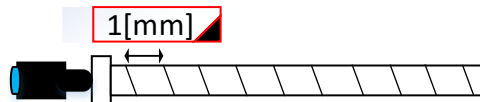

Thus, you just have to input 1 [UU] for Distance to move the linear motor 1 [mm].

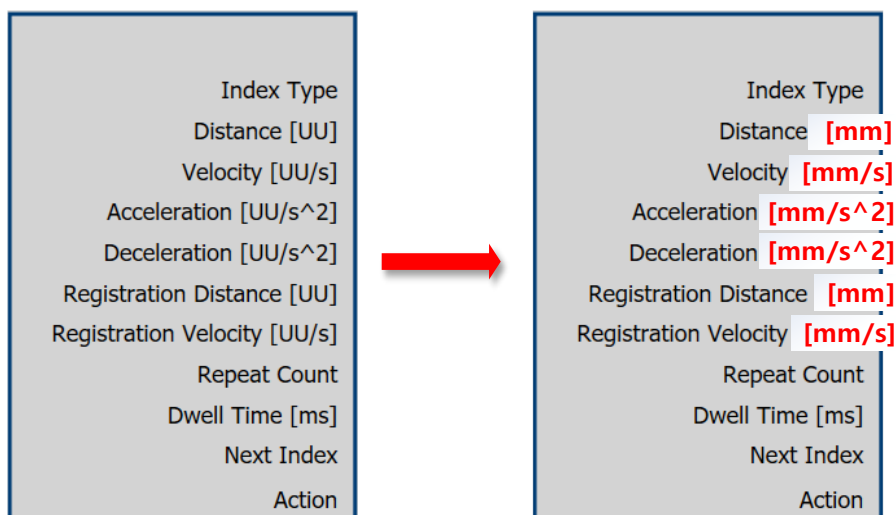

This is how we can change [UU] to [mm] for easier operation.

Also, the changed unit is applied to velocity, acceleration, and deceleration.

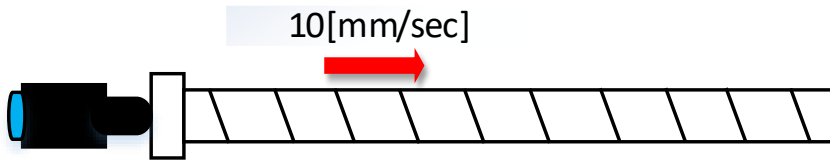

Let's say you have a linear motor that moves 1 [mm] per 1 [turn] and want to move it at the speed of 10 [mm] per second.

Index Type		Index 0
Distance [mm]		1000
Velocity [mm/s]		10

If you enter 10 for Velocity, the linear motor will move 1000 [mm] for 100 [sec] at the speed of 10 [mm/sec].

Velocity [mm/s]	1000
Acceleration [mm/s <sup>2</sup> ]	10000
Deceleration [mm/s <sup>2</sup> ]	10000

Acceleration and deceleration are also converted to [mm]. Travel time [sec] can be calculated according to the equation below.

$$\text{Travel time[sec]} = \frac{\text{Velocity}[\mu\text{u/s}]}{\text{Acceleration or Deceleration}[\mu\text{u/sec}^2]}$$

If velocity is 1000 [mm/sec] and acceleration or deceleration is 10000 [mm/s<sup>2</sup>],

$$0.1[\text{sec}] = \frac{1000[\text{mm/s}]}{10000[\text{mm/sec}^2]}$$

it will take the linear motor 0.1 [sec] to accelerate from 0 [mm/sec] to 1000 [mm/sec]. Like this, value input can become much easier if you change the user unit [UU] to a custom load unit.

## (2) When building a device that requires precision

Using gear ratio also makes it possible to make movements in precise units.

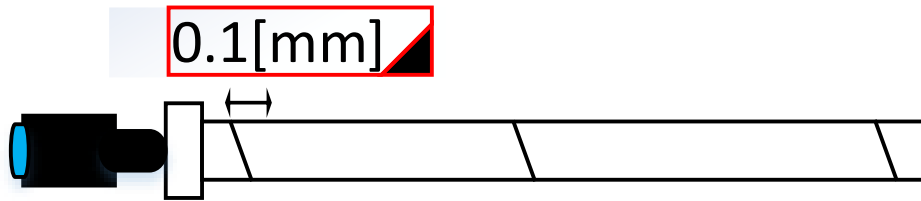



For example, let's say you have a motor attached with a 19 [bit] encoder and a ball screw linear motor that moves 1 [mm] per 1 [turn] installed on it.

If you want to make the ball screw move by 0.1 [mm] by inputting 1 [UU], the gear ratio formula is as follows.

$$\begin{aligned} \text{Index Distance [UU]} \times \frac{\text{Electric Gear Numerator1}}{\text{Electric Gear Denominator1}} &= \text{Internal command pulse [Pulses]} \\ &= 1[\text{UU}] \times \frac{524288}{10} = 52428[\text{Pulses}] \end{aligned}$$

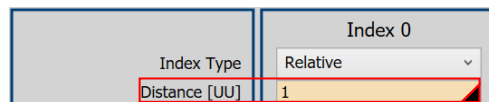
For the linear motor to move 0.1 [mm], the motor must make 0.1 [turn]. Therefore, you must enter 10 into Electric Gear Denominator 1[0x3010]. Then, the internal command pulse becomes 52428 [Pulses], and the motor makes 0.1 [turn] while the linear motor moves by 0.1 [mm].



 Same units

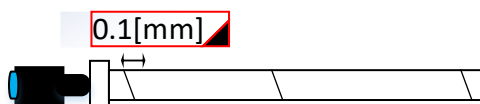

Here, the input distance unit becomes 0.1 [mm]. In the same way, if you need to make a movement of 0.01 [mm] or 0.001 [mm], you can enter a larger value into Electric Gear Denominator 1[0x3010] to increase precision.

### (3) When it is necessary to unify the units of encoders with different resolutions

By applying gear ratio, you can give commands based on the user unit, regardless of the encoder (motor) type. The following example is for a movement of 12mm for the ball screw type with a 10mm pitch.

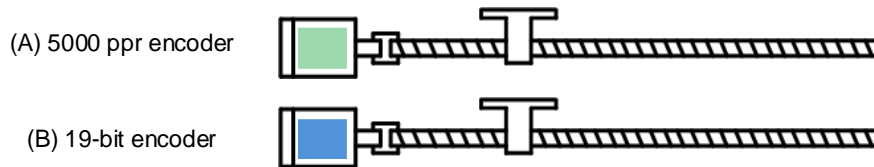

	(A) 5000 ppr encoder	(B) 19-bit (524288 ppr) encoder
When the electric gear is not used	$5000 \times 12 / 10 = 6000$	$524288 \times 12 / 10 = 629145.6$
	Different commands should be given to the encoders (motor) used for the same distance movement.	
<b><u>For a command given in the minimum user unit of 1 <math>\mu\text{m}</math> (0.001 mm)</u></b>		
Electric gear setting	Electric Gear Numerator 1 = 5000 Electric Gear Denominator 1 = 10000	Electric Gear Numerator 1 = 524288 Electric Gear Denominator 1 = 10000
If the electric gear is used	Movements can be made under the same command of 12000 ( $12\text{mm} = 12000 \times 1\mu\text{m}$ ) regardless of the encoder (motor) used.	

### (4) When the output frequency of the upper level controller (master) or input frequency of the drive is limited for driving a high-resolution encoder at a high speed

The output frequency of a general high-speed line drive pulse output unit is approximately 500Kpps, and the possible input frequency of the drive is approximately 1Mpps. For this reason, when driving a high-resolution encoder at a high speed, it is necessary to use an electric gear for proper operation due to the limitations on the output frequency of the upper level controller and the input frequency of the drive.

## 11.3.2 Example of Indexing Position Operation Electric Gear Setting

### ■ Ball Screw Load

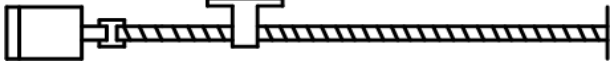
Apparatus specification	 <p>Pitch: 10mm, Deceleration ratio: 1/1</p>
User unit	1um (0.001mm)
Encoder specification	19-bit (524288 PPR)
Load movement amount/revolution	10 [mm]= 10000 [User Unit]
Electric gear setting	Electric Gear Numerator 1 : 524288 Electric Gear Denomiator 1 : 10000

### ■ Turntable Load

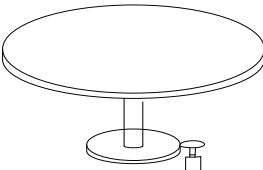
Apparatus specification	 <p>Deceleration ratio: 100/1</p>
User unit	0.001°
Encoder specification	19-bit (524288 PPR)
Load movement amount/revolution	360/100/0.001= 3600
Electric gear setting	Electric Gear Numerator 1 : 524288 Electric Gear Denomiator 1 : 3600

### ■ Belt + Pulley System

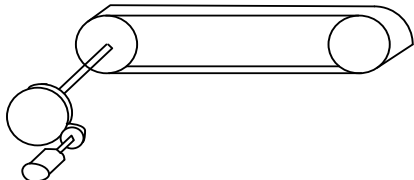
Apparatus specification	 <p>Deceleration ratio: 10/1, Pulley diameter: 100mm</p>
User unit	1um (0.001mm)
Encoder specification	19-bit (524288 PPR)
Load movement amount/revolution	$\pi * 100/10/0.001 = 31416$
Electric gear setting	Electric Gear Numerator 1 : 524288 Electric Gear Denomiator 1 : 31416

## 11.3.3 Calculation of Velocity and Acceleration/Deceleration for Use of Electric Gear

- How to Set Index Velocity

When the gear ratio is 1:1, the following proportional expression for velocity and acceleration/deceleration applies.

$$\begin{aligned} \text{Encoder Pulse per Resolution}[ppr] : 60[rpm] \\ = \text{Index Velocity}[uu/s] : \text{Demand Speed}[rpm] \end{aligned}$$

To drive a 19-bit motor at 3000 [rpm], you can calculate the index velocity as follows.

$$\begin{aligned} 524288[ppr] : 60[rpm] = \text{Index Velocity}[uu/s] : 3000[rpm] \\ \text{Index Velocity}[uu/s] = 26214400[uu/s] \end{aligned}$$

If the gear ratio is other than 1:1, it affects the velocity. Thus, use the following formula taking the gear ratio into consideration.

$$\begin{aligned} \text{Index Velocity}[UU/sec] \\ = \text{Demand Speed}[rpm] \times \frac{\text{Encoder Pulse per Resolution}}{\text{Electric Gear Numerator 1}} \times \frac{\text{Electric Gear Denominator 1}}{60[rpm]} \end{aligned}$$

\* Application example

Calculation of index velocity input value when you want to drive a 19 bit motor at 3000 [rpm] by applying the gear ratio of electric gear numerator 1 : 524288 and electric gear denominator 1 : 20

$$\begin{aligned} \text{Index Velocity}[UU/sec] = 3000[rpm] \times \frac{524288}{524288} \times \frac{20}{60[rpm]} \\ \text{Index Velocity}[uu/s] = 1000[UU/sec] \end{aligned}$$

Index 0	
Index Type	Relative
Distance [UU]	524288
Velocity [UU/s]	1000
Acceleration [UU/s <sup>2</sup> ]	10000
Deceleration [UU/s <sup>2</sup> ]	10000
Registration Distance [UU]	100000
Registration Velocity [UU/s]	1000000
Repeat Count	1
Dwell Time [ms]	200
Next Index	1
Action	Next Index
	Copy Paste

If you enter 1000 [UU/s] for index velocity, the motor runs at 3000 [rpm].

- How to Set Index Acceleration/Deceleration

You can calculate acceleration and deceleration by the following formula using time of concentration and index velocity.

$$\text{Time of concentration[sec]} = \frac{\text{Velocity[uu/s]}}{\text{Acceleration or Deceleration[uu/sec}^2\text{]}}$$

Time of concentration is the time required to reach the target, that is, the time required for the feedback speed to reach the registered velocity.

\* Application example

When you want the feedback speed to reach 3000 [rpm] in 0.1 second for a 19 bit motor with the gear ratio of electric gear numerator 1 : 524288/electric gear denominator 1 : 20

$$0.1[\text{sec}] = \frac{1000[\text{uu/s}]}{\text{Acceleration or Deceleration}[\text{uu/sec}^2]}$$

$$\text{Acceleration or Deceleration}[\text{uu/sec}^2] = 10000[\text{UU/sec}^2]$$

Index 0	
Index Type	Relative
Distance [UU]	524288
Velocity [UU/s]	1000
Acceleration [UU/s <sup>2</sup> ]	10000
Deceleration [UU/s <sup>2</sup> ]	10000
Registration Distance [UU]	100000
Registration Velocity [UU/s]	1000000
Repeat Count	1
Dwell Time [ms]	200
Next Index	1
Action	Next Index
<input type="button" value="Copy"/> <input type="button" value="Paste"/>	

You can set acceleration and deceleration as shown above.



## 11.3.4 Electric Gear for Pulse Input Position Operation

While Index Position operation only uses 1 electric gear, pulse input position operation can use up to 4 electric gears by using the EGEAR1 and EGEAR2 signals among input contacts.

EGEAR1	EGEAR2	Electric Gear Ratio Numerator/Denominator	Electric Gear Ratio
OFF	OFF	Electric Gear Numerator 1 [0x300C]	Electric gear ratio 1
		Electric Gear Denominator 1 [0x3010]	
ON	OFF	Electric Gear Numerator 2 [0x300D]	Electric gear ratio 2
		Electric Gear Denominator 2 [0x3011]	
OFF	ON	Electric Gear Numerator 3 [0x300E]	Electric gear ratio 3
		Electric Gear Denominator 3 [0x3012]	
ON	ON	Electric Gear Numerator 4 [0x300F]	Electric gear ratio 4
		Electric Gear Denominator 4 [0x3013]	

## 11.4 Velocity Control Settings

### 11.4.1 Smooth Acceleration and Deceleration

For smoother acceleration and deceleration during velocity control, you can generate an acceleration/deceleration profile of a trapezoidal or S-curved shape. Here, You can enable S-curve operation by setting the speed command S-curve time to 1 [ms] or higher.

The velocity command acceleration/deceleration time (0x2301, 0x2302) is the time needed to accelerate the drive from the zero speed to the rated speed or to decelerate it from the rated speed to the zero speed.

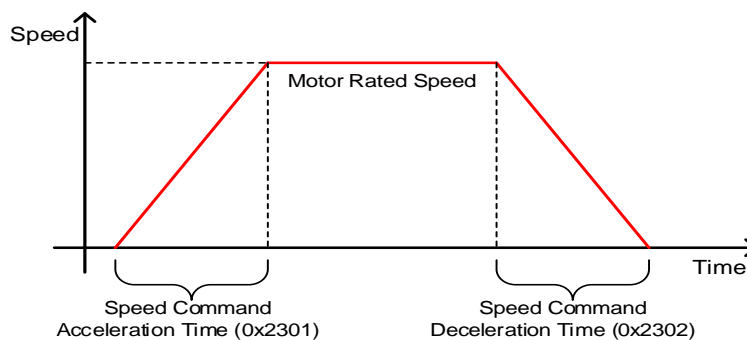

You can calculate the actual acceleration/deceleration time as below.

Acceleration time= speed command/rated speed x speed command acceleration time (0x2301)

Deceleration time= speed command/rated speed x speed command deceleration time (0x2302)

As shown in the figure below, you can generate an S-curve shape acceleration/deceleration profile by setting the speed command S-curve time (0x2303) to 1 or a higher value. Make sure to verify the relationship between the acceleration/deceleration time and S-curve time.

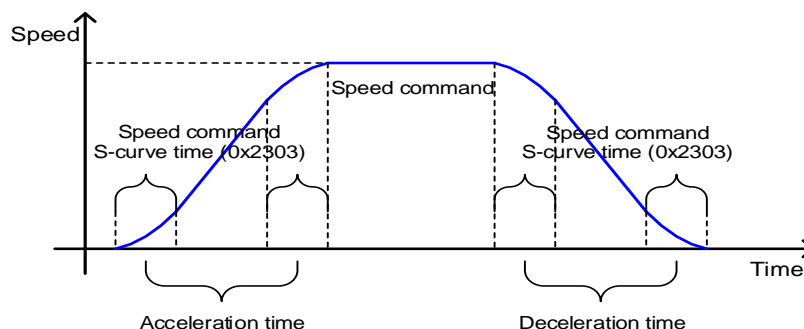

## 11.4.2 Smooth Acceleration and Deceleration Through Step Analog Voltage Input

When controlling speed using analog input voltage, you can use step voltage input to achieve smooth acceleration and deceleration. For proper operation, you must enter 1 [msec] or lower for step voltage change time.

<CH1: Input voltage>

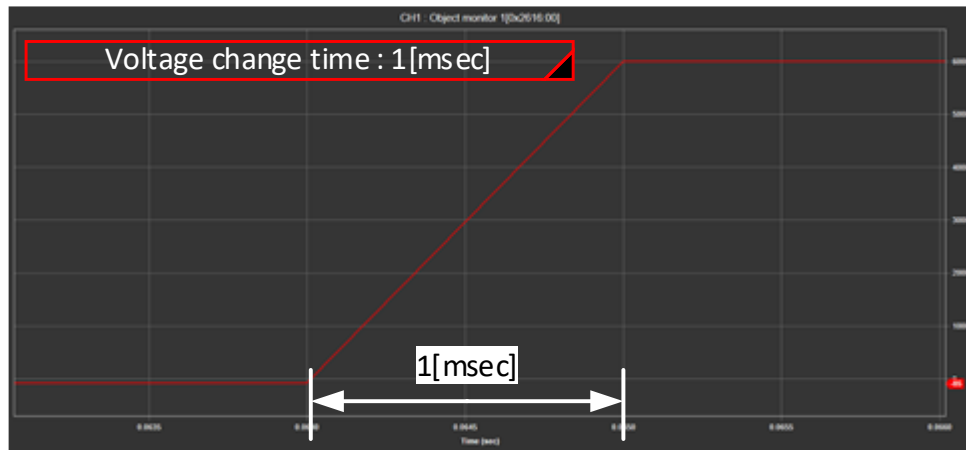

Index	SubIndex	Name	Value	Default
0x2301	0x0	Speed Command Acceleration Time	200	200
0x2302	0x0	Speed Command Deceleration Time	200	200
0x2303	0x0	Speed Command S-curve Time	0	0

As shown above, if you input 200 [msec] for Speed Command Acceleration Time [0x2301] and Speed Command Deceleration Time [0x2302] and input a step analog voltage, the speed command reflects the acceleration/deceleration time and is output in a trapezoidal shape.

<CH1: Input voltage/CH2: Speed command>

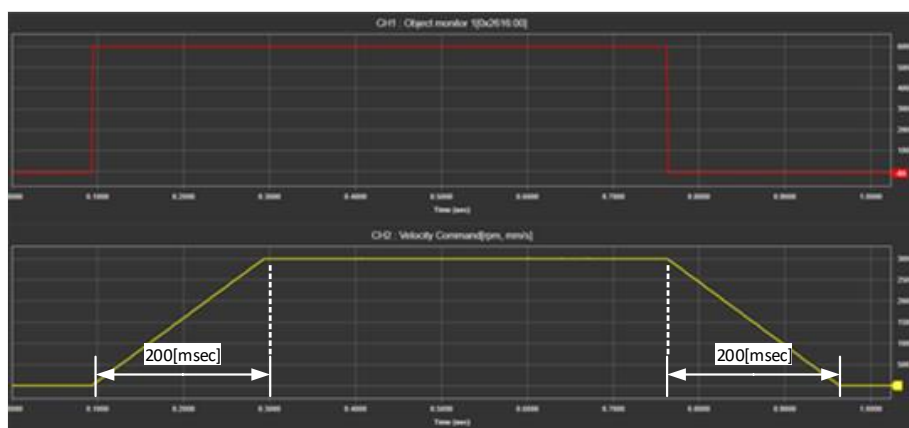

Index	SubIndex	Name	Value	Default
0x2301	0x0	Speed Command Acceleration Time	200	200
0x2302	0x0	Speed Command Deceleration Time	200	200
0x2303	0x0	Speed Command S-curve Time	100	0

If you input 100 for Speed Command S-curve Time[0x2303] and input a step voltage, the voltage command reflects the acceleration/deceleration time and S-curve time and is output in a smooth curve.

<CH1: Input voltage/CH2: Velocity command>

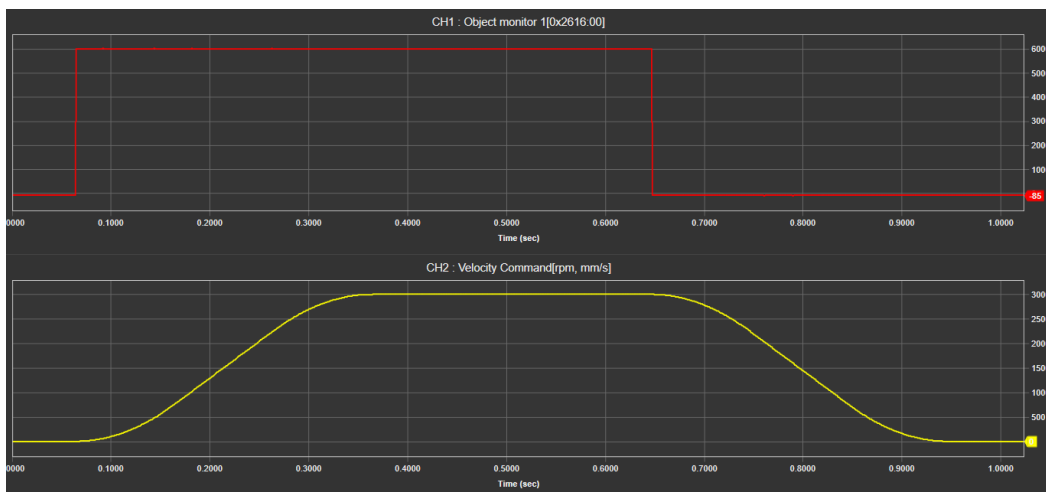

## 11.4.3 Servo-lock Function

During velocity control operation, the servo position cannot be locked even when 0 is entered for the velocity command. This is due to the characteristic of velocity control. Here, you can lock the servo position by enabling the servo-lock function (0x2311).

Setting Values	Setting Details
0	Servo-lock function disabled
1	Servo-lock function enabled

Using the servo-lock function, you can internally control the positions based on the position of 0 velocity command input. If you input a velocity command other than 0, the mode switches to normal velocity control.

## 11.4.4 Velocity Control Signals

As shown in the figure below, when the value of speed feedback is below the ZSPD output range (0x2404), a ZSPD (zero speed) signal is output; and when it is above the TGON output range (0x2405), a TGON (motor rotation) signal is output.

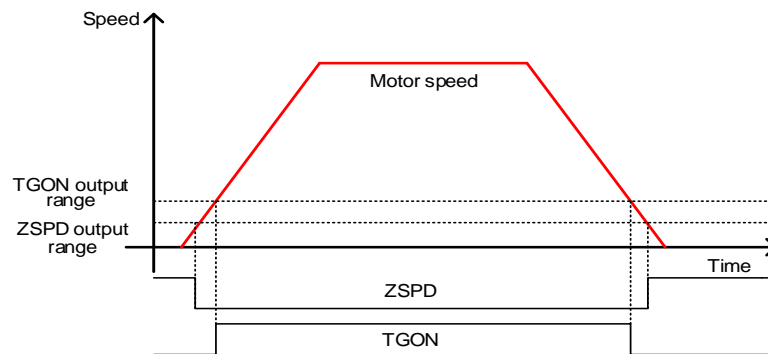

In addition, if the difference between the command and the speed feedback (i.e., velocity error) is below the INSPD output range (0x2406), an INSPD (velocity match) signal is output.

### ■ Related Objects

Index	Sub Index	Names	Variable Types	Accessibility	PDO Assignment	Unit
0x2404	-	ZSPD Output Range	UINT	RW	Yes	rpm
0x2405	-	TGON Output Range	UINT	RW	Yes	rpm
0x2406	-	INSPD Output Range	UINT	RW	Yes	rpm

## 11.5 Position Control Settings

### 11.5.1 Position Command Filter

You can apply filters to position commands to operate the drive more smoothly. For filtering, you can set position command filter time constant (0x2109) using the primary low pass filter and position command average filter time constant (0x210A) using the movement average.

You can use a position command filter in the following cases.

- (1) When the electric gear ratio is x10 or above
- (2) When the acceleration/deceleration profile cannot be generated from the upper level controller

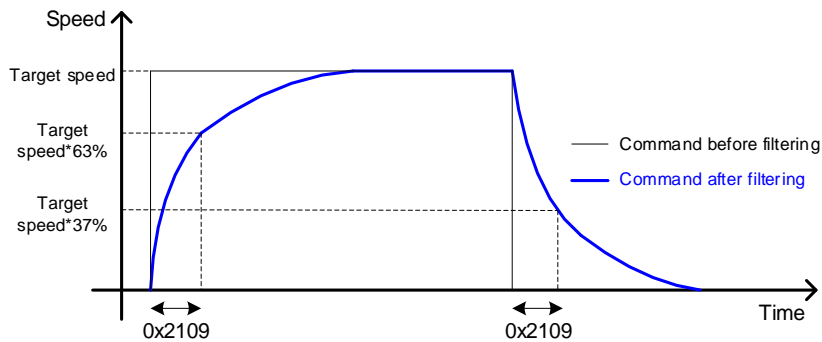

Position command filter using position command filter time constant (0x2109)

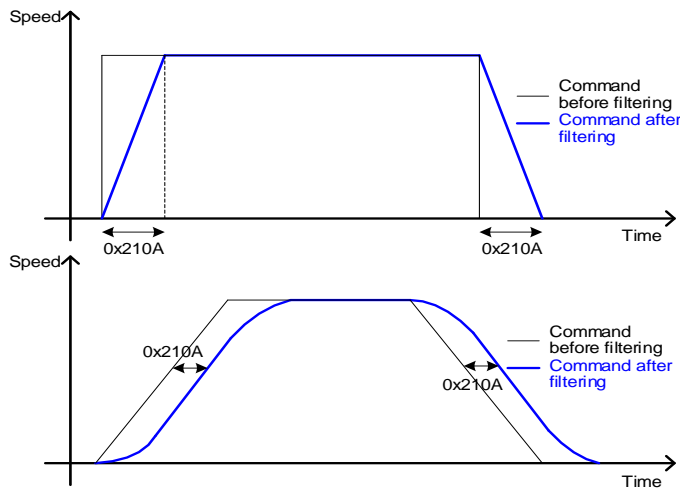

Position command filter using position command average filter time constant (0x210A)

**■ Related Objects**

Index	Sub Index	Names	Variable Types	Accessibility	PDO Assignment	Unit
0x2109	-	Position Command Filter Time Constant	UINT	RW	Yes	0.1ms
0x210A	-	Position Command Average Filter Time Constant	UINT	RW	Yes	0.1ms

## 11.5.2 Position Control Signals

As shown in the figure below, if the position error value (i.e., the difference between the position command value input by the upper level controller and the position feedback value) is below the INPOS1 output range (0x2401) and is maintained for the INPOS1 output time (0x2402), the INPOS1 (Positioning completed 1) signal is output. However, the signal is output only when the position command is not renewed.

Here, if the position error value goes below the INPOS2 output range (0x2403), the INPOS2 (Positioning completed 2) signal is output regardless of whether or not the position command has been renewed.

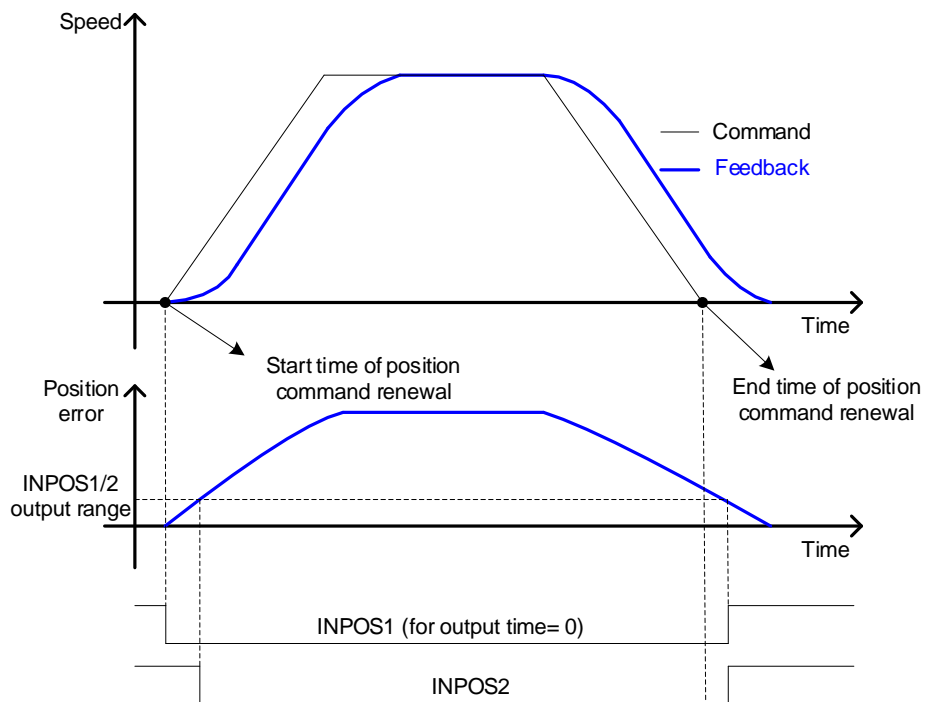

### ■ Related Objects

Index	Sub Index	Names	Variable Types	Accessibility	PDO Assignment	Unit
0x2401	-	INPOS1 Output Range	UINT	RW	Yes	UU
0x2402	-	INPOS1 Output Time	UINT	RW	Yes	ms
0x2403	-	INPOS2 Output Range	UINT	RW	Yes	UU



## 11.6 Positive/Negative Limit Setting

This function is used to safely operate the drive within the movable range of the apparatus using the positive/negative limit signals of the drive. Be sure to connect and set the limit switch for safe operation. For more information about the settings, refer to Section 10.2.1, “Digital Input Signal Assignment.”

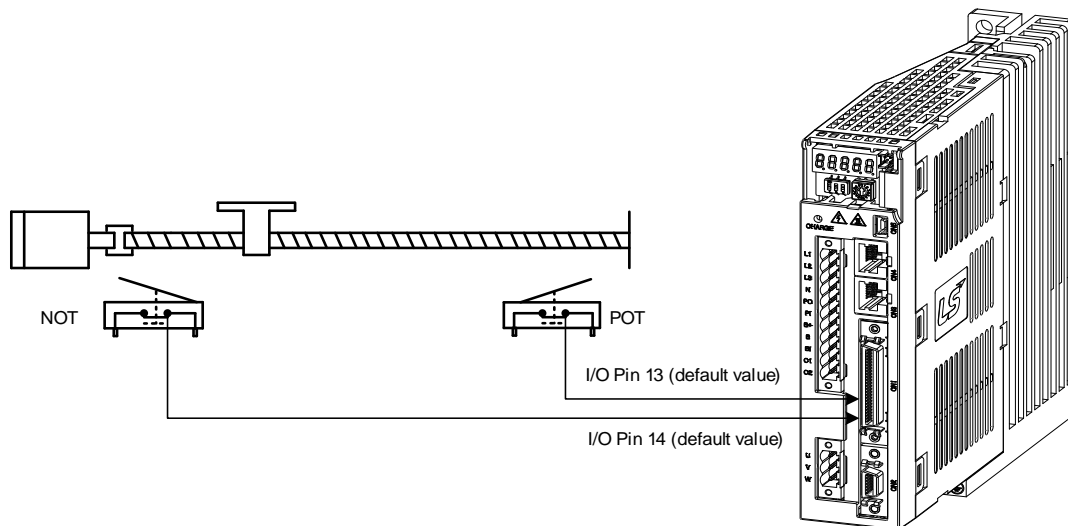

When a positive/negative limit signal is input, the motor stops according to the emergency stop setting (0x2013).

Setting Values	Description
0	The motor stops according to the method set in Dynamic Brake Control Mode (0x2012). It stops using the dynamic brake and maintains the torque command at 0.
1	The motor decelerates to a stop using the emergency stop torque (0x2113).

### ■ Related Objects

Index	Sub Index	Names	Variable Types	Accessibility	PDO Assignment	Unit
0x2012	-	Dynamic Brake Control Mode Configuration	UINT	RW	No	-
0x2013	-	Emergency Stop Configuration	UINT	RW	No	-
0x2113	-	Emergency Stop Torque	UINT	RW	Yes	-

## 11.7 Brake Output Signal Function Setting

If the motor stops due to the servo off state or servo alarm during rotation, you can set the velocity (0x2407) and delay time (0x2408) for brake signal output in order to set the output timing.

The brake signal is output if the motor rotation velocity goes below the set value (0x2407) or the output delay time (0x2408) has been reached after the servo off command.

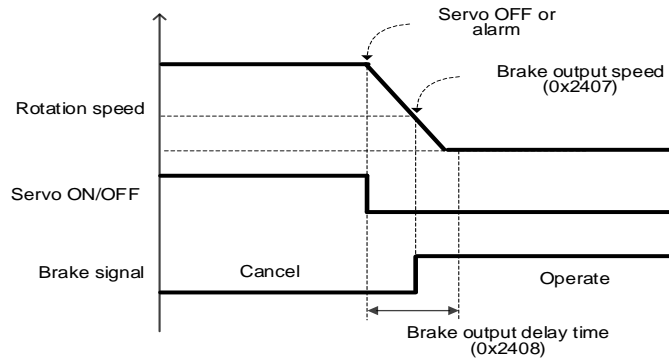

Timing diagram for signal output by the brake output speed (0x2407)

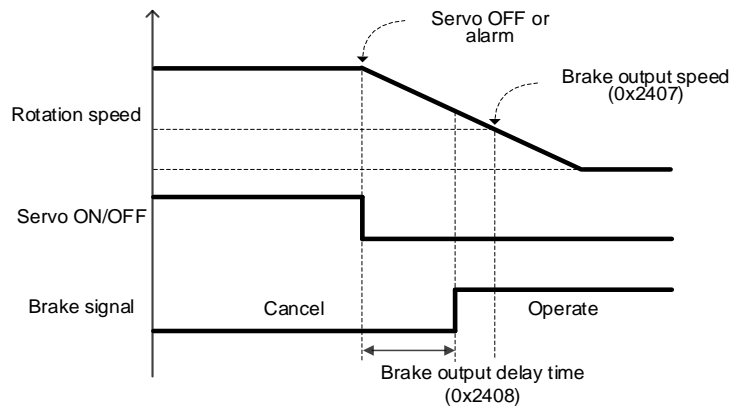

Timing diagram for signal output by the brake output delay time (0x2408)

You can set the delay time until the actual PWM output goes off when the servo is turned off or a servo alarm occurs.

When using a motor with a brake installed on the vertical axis, you can output the brake signal first and turn off PWM after the set time in order to prevent it from running down along the axis.

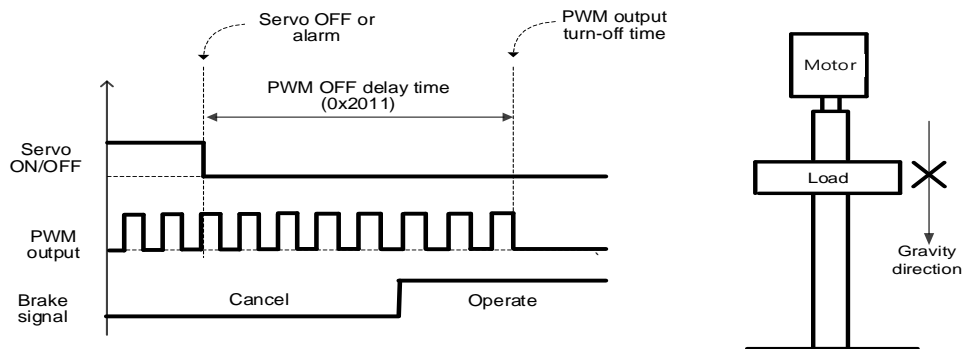

(1) When the brake signal is output before PWM output is turned off

You can output the brake signal first before PWM output is turned off to prevent the drop along the vertical axis due to gravity.

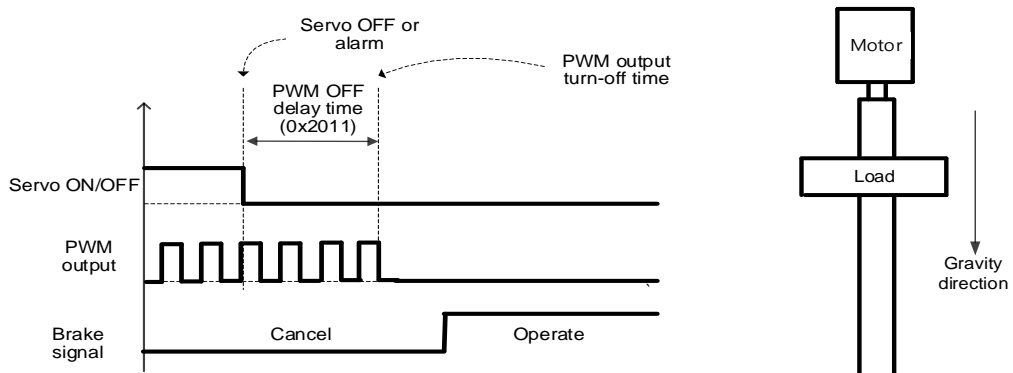

(2) If PWM output is turned off before the brake signal output

PWM output is turned off before the brake signal output, allowing the drop along the vertical axis due to gravity.

# 11.8 Torque Limit Function

You can limit the drive's output torque to protect the machine. You can set the limit on torque output in torque limit function setting (0x2110). The setting unit of torque limit value is [0.1%].

- Description of torque limit function setting (0x2110)

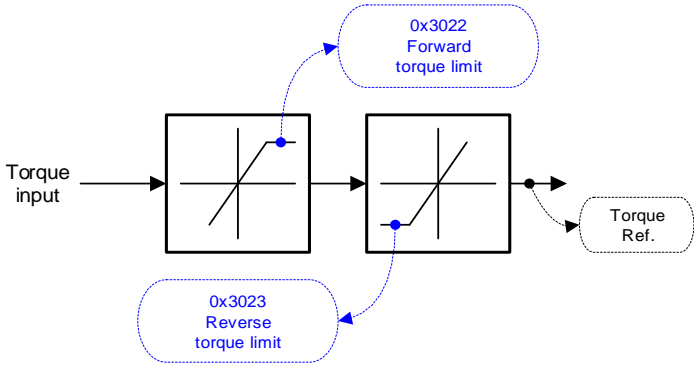
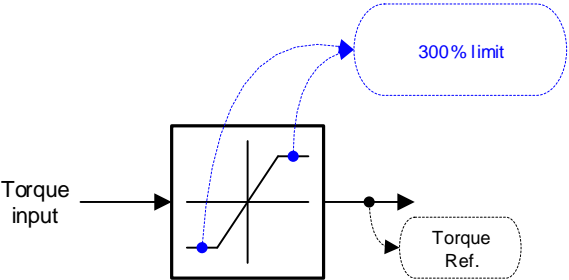
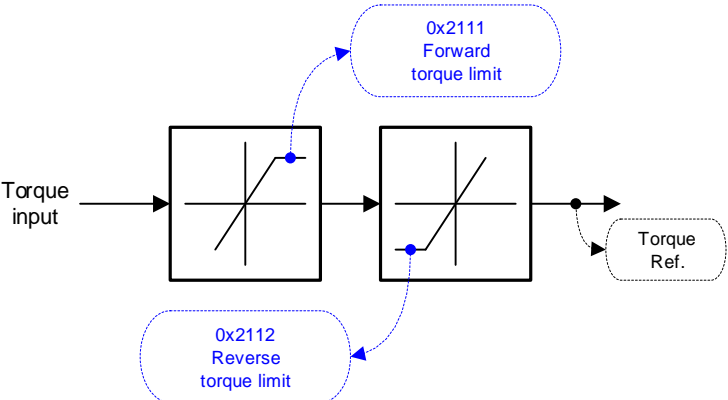
Limit function	Description
Internal Torque Limit 1 (Setting value 0)	 <p>Limits the torque value using positive/negative torque limits according to the driving direction                      - Forward: 0x3022, reverse: 0x3023</p>
Internal Torque Limit 2 (Setting value 1)	 <p>Limited to 300% regardless of the driving direction</p>
External Torque Limit (Setting value 2)	 <p>Limits the torque value using external positive/negative torque limits according to the driving direction                      - Forward: 0x2111, Reverse: 0x2112</p>

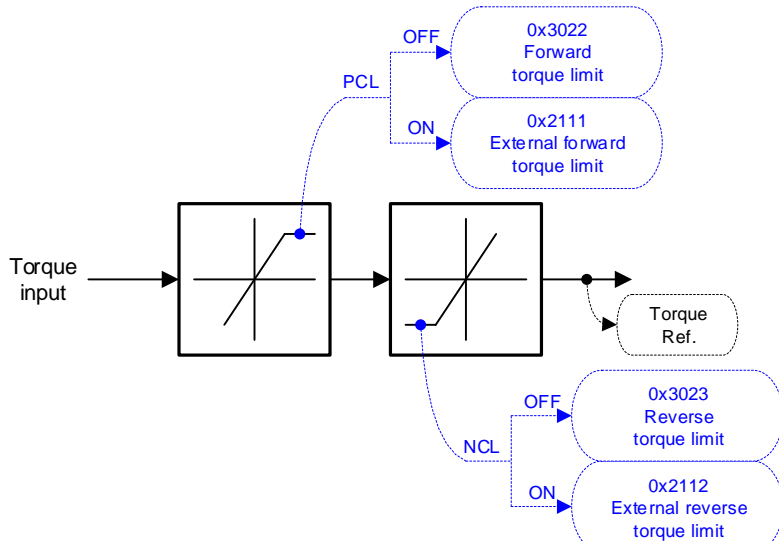
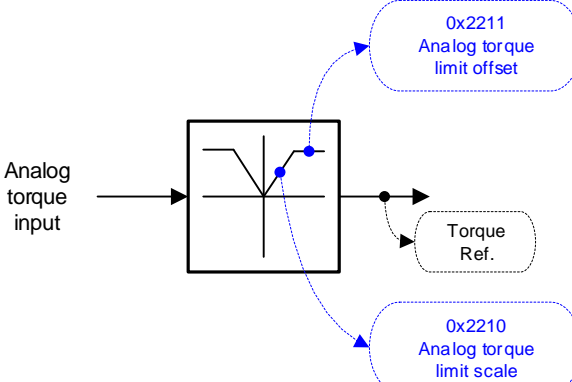
<p>Internal + External Torque Limits (Setting value 3)</p>	 <p>Limits the torque value using internal and external torque limits according to the driving direction and the torque limit signal</p> <ul style="list-style-type: none"> <li>- Forward: 0x3022 (no PCL input), 0x2111 (PCL input)</li> <li>- Reverse: 0x3023 (no NCL input), 0x2112 (NCL input)</li> </ul>
<p>Analog Torque Limit (Setting value 4)</p>	 <p>The torque limits are set according to analog input voltage</p> <ul style="list-style-type: none"> <li>-The torque limit values in the forward and reverse directions are set in proportion to the absolute values of input voltage, regardless of the signals of analog input voltage. .</li> <li>- The torque limit and the analog input voltage have the following relationship.</li> <li>- The limit value can be determined by using the following formula.</li> </ul> $\text{Torque limit value}\% = \left( \frac{ \text{Input voltage [mV]}  - \text{Torqueinput offset}(0x2211)[\text{mV}]}{\text{Torque command scale}[0x2210]} \right) \times \frac{1000}{10}$ <p>ex) the command scaler is set to 100 and the offset is set to 0</p> <p>When the input voltage is -10[V],</p> $\text{Torque limit value}\% = \left( \frac{ -10000[\text{mV}]  - 0[\text{mV}]}{1000} \right) \times \frac{100}{10} = 100\%$ <p>The torque values in the forward and reverse directions are set up to 100[%]. If you enter an input voltage of 10[V], the torque values in the forward and reverse directions are also set up to 100[%]</p>

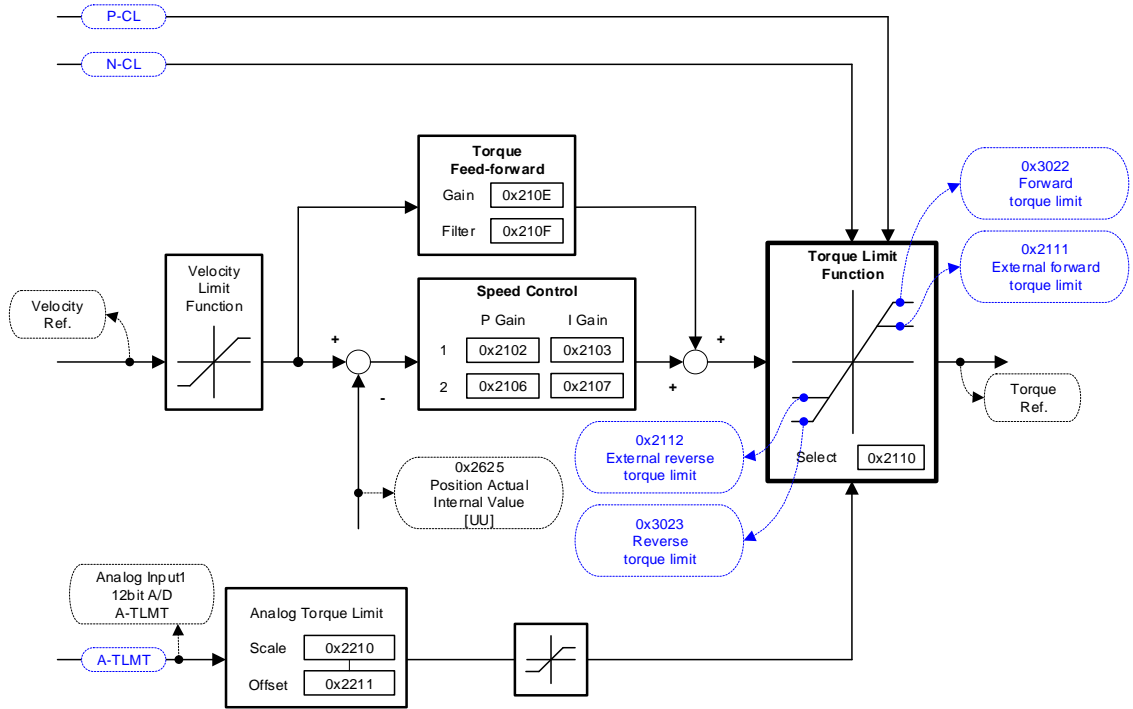

■ Related Objects

Index	Sub Index	Names	Variable Types	Accessibility	PDO Assignment	Unit
0x2110	-	Torque Limit Function Select	UINT	RW	Yes	-
0x2111	-	External Positive Torque Limit Value	UINT	RW	Yes	0.1%
0x2112	-	External Negative Torque Limit Value	UINT	RW	Yes	0.1%
0x3022	-	Positive Torque Limit Value	UINT	RW	Yes	0.1%
0x3023	-	Negative Torque Limit Value	UINT	RW	Yes	0.1%

## 11.9 Gain Conversion Function

### 11.9.1 Gain Group Conversion

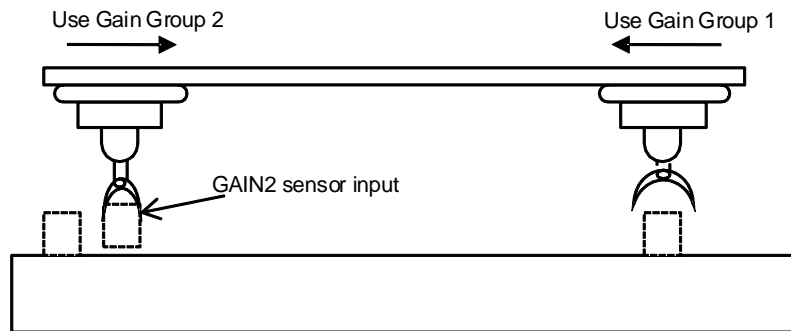

This is one of the gain adjustment functions and is used to switch between Gain Groups 1 and 2. You can reduce the time required for positioning through gain conversion.

A gain group consists of position loop gain, speed loop gain, Speed Loop Integral Time Constant, and torque command filter time constant. You can set the gain conversion function (0x2119) as follows.

- Description of Gain Conversion Function (0x2119)

Setting Values	Setting Details
0	Only Gain Group 1 is used
1	Only Gain Group 2 is used
2	Gain is switched according to the GAIN2 input status - 0: Use gain group 1 - 1: Use gain group 2
3	Reserved
4	Reserved
5	Reserved
6	Gain is switched according to the ZSPD output status - 0: Use gain group 1 - 1: Use gain group 2
7	Gain is switched according to the INPOS1 output status - 0: Use gain group 1 - 1: Use gain group 2

Waiting time and switching time for gain conversion are as follows.

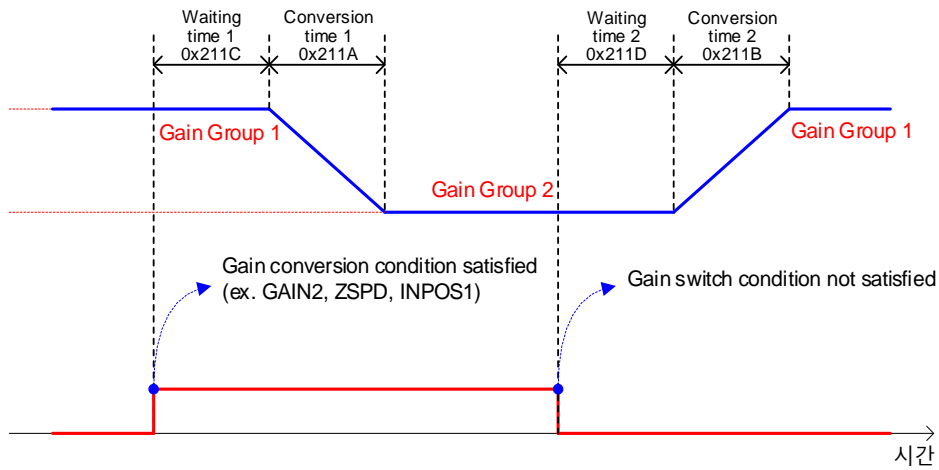
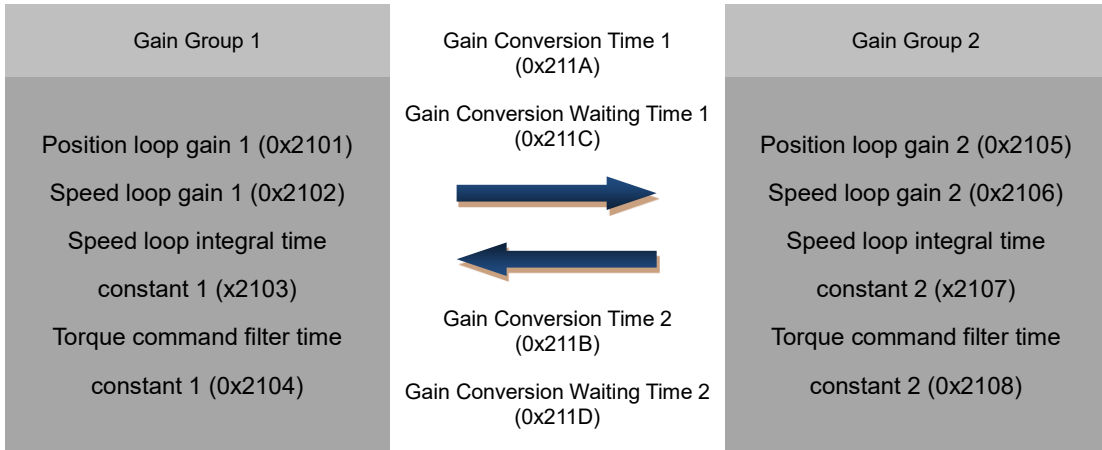

■ Related Objects

Index	Sub Index	Names	Variable Types	Accessibility	PDO Assignment	Unit
0x2119	-	Gain Conversion Mode	UINT	RW	Yes	-
0x211A	-	Gain Conversion Time 1	UINT	RW	Yes	ms
0x211B	-	Gain Conversion Time 2	UINT	RW	Yes	ms
0x211C	-	Gain Conversion Waiting Time 1	UINT	RW	Yes	ms
0x211D	-	Gain Conversion Waiting Time 2	UINT	RW	Yes	ms



## 11.9.2 P/PI control switch

PI control uses both proportional (P) and integral (I) gains of the velocity controller, while P control uses only proportional gain.

The proportional gain determines the responsiveness of the entire controller, and the integral gain is used to eliminate errors in the steady state. Too high of an integral gain will result in an overshoot during acceleration or deceleration.

The P/I control switch function is used to switch between the PI and P controls under the condition of the parameters within the servo (torque, velocity, acceleration, position deviation); specifically, they are used in the following situations.

Velocity control: To suppress any overshoot or undershoot during acceleration/deceleration

Position control: To suppress undershoots during positioning in order to reduce the positioning time

You can accomplish similar effects by setting acceleration/deceleration of the upper level controller, soft start of the servo drive, position command filter, etc.

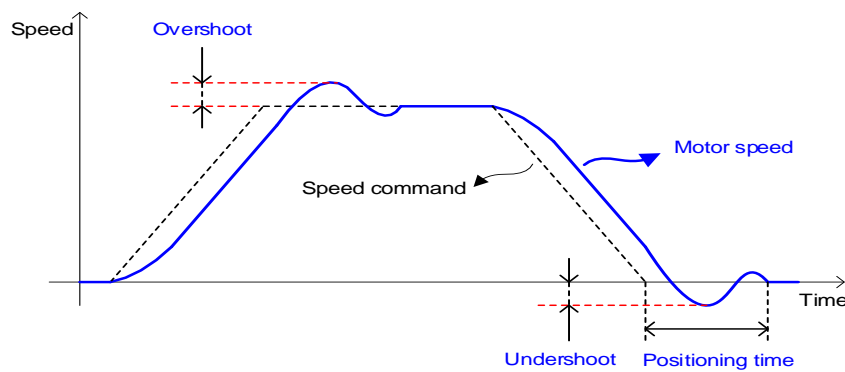

You make these settings in the P/PI control switch mode (0x2114). See the details below. Switching to P control by PCON input takes precedence over this setting.

Setting Values	Setting Details
0	Always use PI control
1	Switch to P control if the command torque is larger than the P control switch torque (0x2115)
2	Switch to P control if the command speed is larger than P control switch speed (0x2116)
3	Switch to P control if the acceleration command is larger than P control switch acceleration (0x2117)
4	Switch to P control if the position error is larger than P control switch position error (0x2118)

■ Related Objects

Index	Sub Index	Names	Variable Types	Accessibility	PDO Assignment	Unit
0x2114	-	P/PI Control Conversion Mode	UINT	RW	Yes	-
0x2115	-	P Control Switch Torque	UINT	RW	Yes	0.1%
0x2116	-	P Control Switch Speed	UINT	RW	Yes	rpm
0x2117	-	P Control Switch Acceleration	UINT	RW	Yes	rpm/s
0x2118	-	P Control Switch Following Error	UINT	RW	Yes	pulse

■ Example of P/PI Switching by Torque Command

When using PI control for all situations rather than using P/PI control switch for velocity control, the integral term of acceleration/deceleration error is accumulated, which results in an overshoot and an extended positioning time. Here, you can reduce overshoot and positioning time using an appropriate P/PI switching mode. The figure below shows an example of mode switching by torque commands.

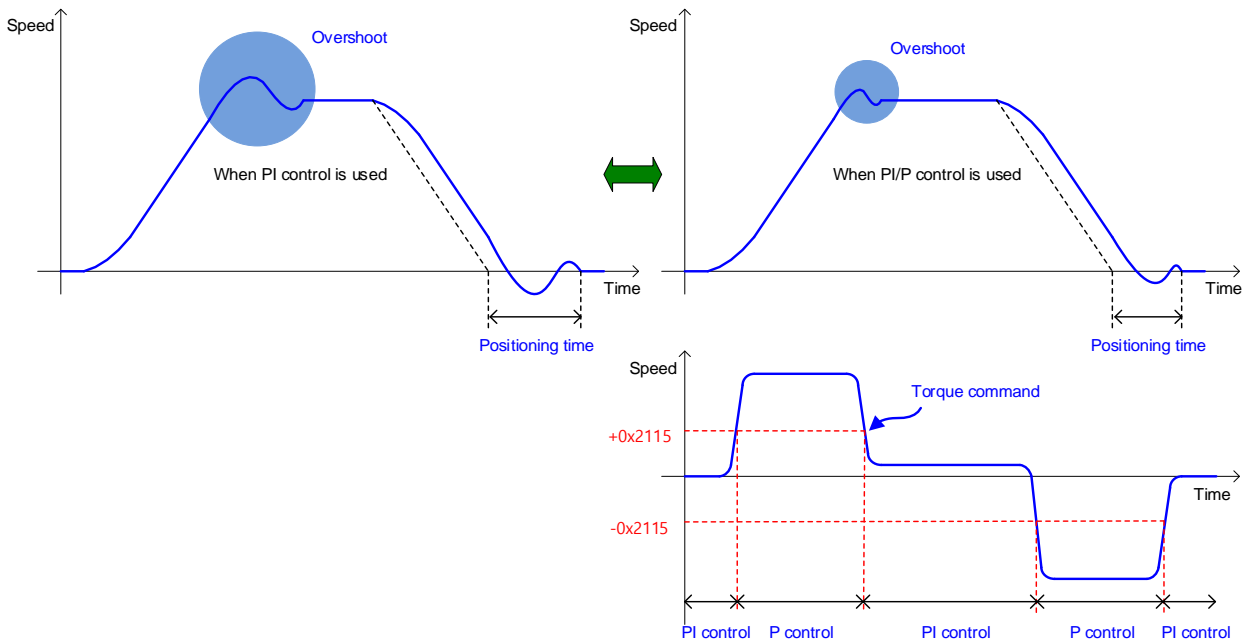

## 11.10 Dynamic Brake

What is dynamic brake?

: It is a method of rapidly stopping the motor by causing an electrical short-circuit to the phases of the servo motor.

Circuits of to the dynamic brake are integrated into the drive.

The drive can apply short-circuits to only two phases or to all three phases depending on the model type.

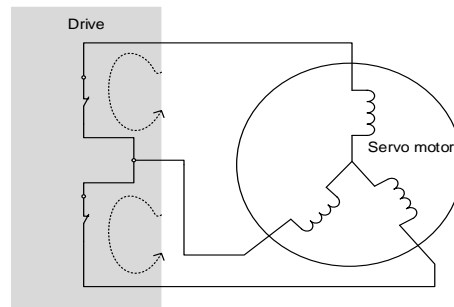

You can set various stop modes as shown below, in dynamic brake control mode setting (0x2012).

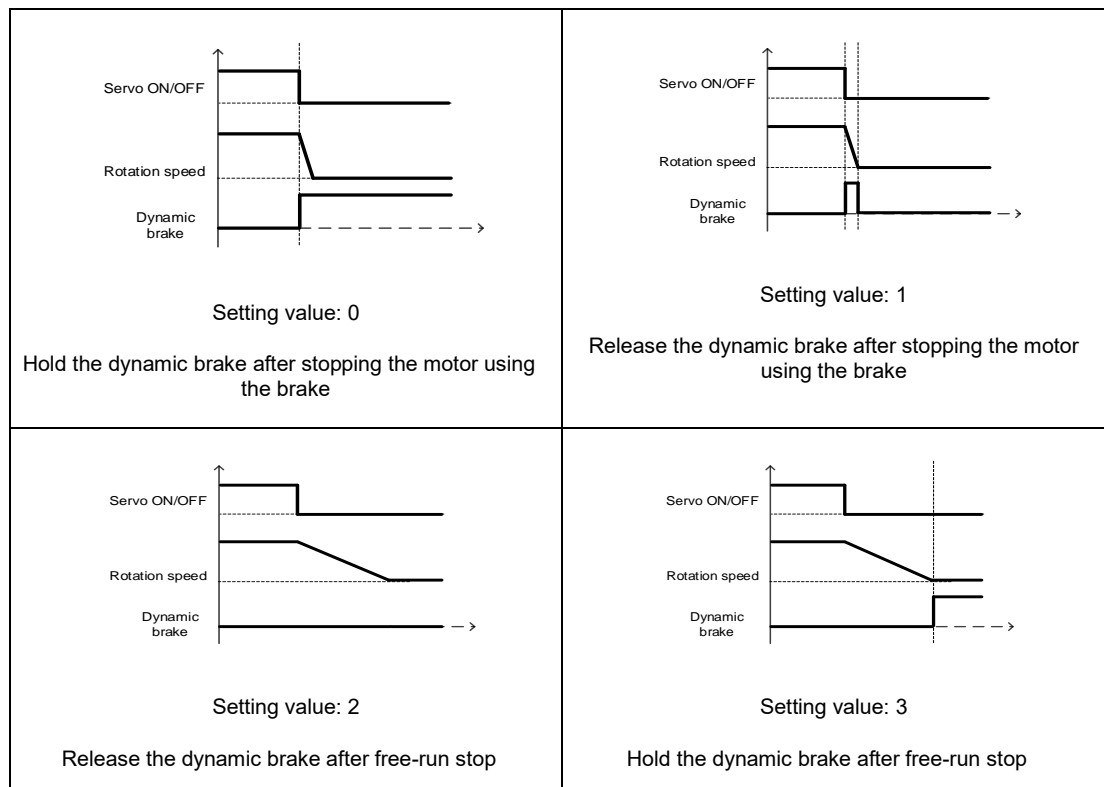

**■ Related Objects**

Index	Sub Index	Names	Variable Types	Accessibility	PDO Assignment	Unit
0x2012	-	Dynamic Brake Control Mode Configuration	UINT	RW	No	-
0x2013	-	Emergency Stop Configuration	UINT	RW	No	-

**⚠ Caution**

- DB is a function used for Servo Off or emergency stop (EMG). Do not use this function to turn off operation in a normal situation.

## 11.11 Regenerative Brake Resistor Setting

Regeneration refers to a phenomenon where kinetic energy of the motor is converted to electric energy and input into the drive because of the high inertia or sudden deceleration of the load driven. Here, a regenerative resistance is used to suppress the rise of the drive's internal voltage ( $V_{DC}$ ) caused by regeneration and prevent burnout of the drive.

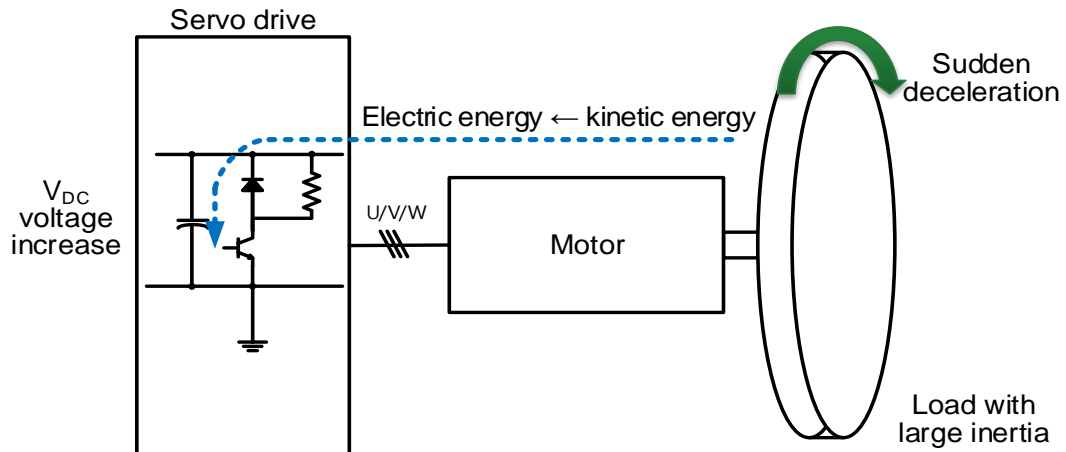

### ■ Related Objects

Index	Sub Index	Names	Variable Types	Accessibility	PDO Assignment	Unit
0x2009	-	Regeneration Brake Resistor Configuration	UINT	RW	No	-
0x200A	-	Regeneration Brake Resistor Derating Factor Setting	UINT	RW	No	%
0x200B	-	Regeneration Brake Resistor Value Setting	UINT	RW	No	$\Omega$
0x200C	-	Regeneration Brake Resistor Power Setting	UINT	RW	No	Watt
0x200D	-	Peak Power of Regeneration Brake Resistor Setting	UINT	RW	No	Watt
0x200E	-	Duration Time @ Peak Power of Regeneration Brake Resistor	UINT	RW	No	ms

## 11.11.1 Use of External regenerative resistance

When using the external regenerative resistance for different driving conditions, make sure to observe the order below for configuration.

### 1. Wiring external regenerative resistance

- Connect the external regenerative resistance to the terminals B and B+.

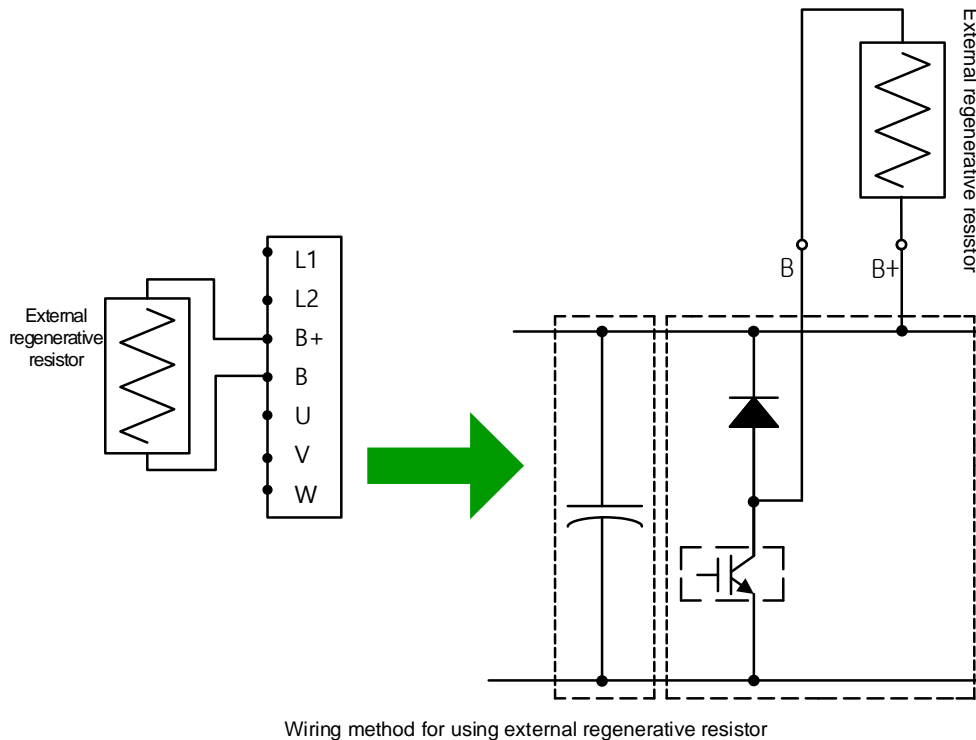

### 2. Setting regenerative resistance (0x2009)

- Configure the regenerative resistance installed separately outside the drive (0x2009=1)
- Initial value: 1

### 3. Setting regenerative resistance value (0x200B)

- Set regenerative resistance of the resistor installed separately outside the drive in the unit of [ $\Omega$ ]
- This setting is required when you have set regenerative resistance (0x2009) to 1
- Initial Value: 0

### 4. Setting regenerative resistor capacity (0x200C).

- Set the capacity of the regenerative resistance installed separately outside the drive in the unit of [W]
- This setting is required when you have set regenerative resistance (0x2009) to 1

- Initial Value: 0
5. Setting maximum capacity and allowed time of the regenerative resistance (0x200D, 0x200E)
- Set the maximum capacity and use time at the capacity by using the data sheet of the externally installed regenerative resistance
  - If there are no specific values provided, set the maximum capacity to a value 5 times the regenerative resistance capacity(0x200C) and the allowed time to 5000[ms](The values may differ according to the general regenerative resistance specifications or the resistance value)
  - This setting is required when you have set regenerative resistance (0x2009) to 1

Our company provides the following regenerative resistance specifications as options for the use of external regenerative resistances.

Drive Capacity	Resistance Values	Resistance Capacity	Model Name
100 W	50Ω	140W	APCS-140R50
200W			
400W			
1KW	30Ω	300W	APCS-300R30

### 11.11.2 Regenerative Overload

When regenerative actions occur continuously, the drive consumes regenerative energy in the form of regenerative resistance through regenerative actions. Since L7C does not have internal regenerative resistance, to apply it to a device with regeneration you must connect it to an appropriate resistor for the capacity range and input the appropriate parameter.

The following is an example of parameter input and AL-23 generation when a resistor of 300 W/30 Ω is attached to a 1 [kW] drive.

First, you must obtain the regenerative consumption capacity. 385[V] is the voltage point at which regenerative actions get activated.

$$\begin{aligned} \text{Regenerative consumption capacity} = P_c &= \frac{385[V]^2}{\text{Regen.Brake Resistor Value}[0x200B][\Omega]} \\ &= \frac{385^2}{30} = 4940.83[W] \end{aligned}$$

Regen. Brake Resistor Value [0x200B] affects the regenerative consumption capacity, so insert precisely.

Next, you need to obtain the regenerative resistance capacity.

Peak Power of Regen. If Brake Resistor [0x200D] value is not set, enter the value five times the Brake Resistor Power [0x200C] value. Also, if there is no mention of allowed time for regenerative resistance, enter 5 [sec].

$$\begin{aligned}
 & \text{Regenerative consumption capacity} = P_L \\
 & = \text{Peak Power of Brake Resistor}[0x200D] \text{ [W]} \\
 & \times \text{Brake Resistor Derating Factor}[0x200A] \text{ [%]} \times 0.01 \\
 & \quad \times \text{Duration Time}[0x200E] \text{ [msec]} \\
 & = 1500 \text{ [W]} \times 100 \text{ [%]} \times 0.01 \times 5 \text{ [sec]} = 7500 \text{ [W]}
 \end{aligned}$$

The maximum regenerative resistance capacity will be calculated as 7500 [W] as above. The greater the possible continuous operation time [0x200E] gets, the greater the maximum regenerative resistance capacity becomes.

AL-23 occurs if the regenerative consumption capacity accumulated during regenerative actions exceeds the maximum regenerative resistance capacity.

$$\begin{aligned}
 \text{Possible continuous operation time} = T_c = \frac{P_L}{P_c} = \frac{7500}{4940.83} = \\
 1.51 \text{ [sec]}
 \end{aligned}$$

If the continuous regenerative actions exceed 1.51[sec], the regenerative overload alarm (AL-23) occurs.

### 11.11.3 Other Considerations

You can set the regenerative resistance's Derating Factor (0x200A) by considering the ambient environment and heat radiation conditions for drive installation. If the heat radiation condition is poor, use a derated (with lowered capacity) resistor.

When it is derated for use (value set to 100 or lower), the less the set value of the regeneration overload alarm (AL-23), the faster its trigger.

When you wish to set the derating factor to 100% or higher, be sure to fully consider the heat radiation condition of the drive installed.



## 11.12 Encoder Signal Output

The drive internally processes the encoder signals and outputs them in the form of a pulse. It outputs the signals in the line drive method through the pins assigned to the CN1 connector by default.

You can set the count of the encoder pulse output per revolution of the motor by the encoder output pulse [0x3006] value.

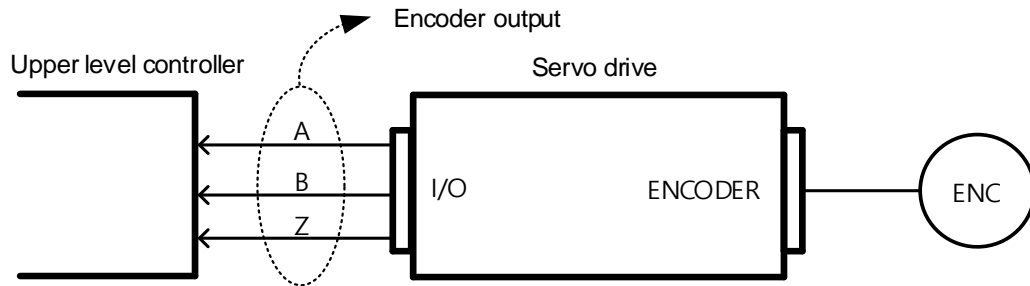

The encoder signal output frequency of the drive is 4 [Mpps] at the maximum for the line drive method.

### ■ Encoder Output Signal for the Line Drive Method

Pin Numbers	Names	Assignment	Description	Functions
1	AO	-	Encoder Signal A	Outputs demultiplied encoder signals in A, B, and Z phases by the line drive method. Output demultiplication can be set in [0x3006].
2	/AO	-		
3	BO	-	Encoder Signal B	
4	/BO	-		
5	ZO	-	Encoder Signal Z	
6	/ZO	-		

### ■ Related Objects

Index	Sub Index	Name	Variable Type	Accessibility	PDO Assignment	Unit
0x3006	-	Encoder Output Pulse	UDINT	RW	No	Pulse/rev.

## 11.13 Absolute Encoder Data Transmission (ABS\_RQ)

Upon request, the absolute encoder's data are transmitted to the upper level controller in the form of quadrature pulses through AO, BO outputs, which are the encoder's output signals. In this case, pulses are output at the velocity of 500 [Kpps].

The drive transmits multi-turn data first among the absolute data upon ABSRQ signal input, then transmits single-turn data within a single revolution. (For assignment of sequence input signal ABSRQ, refer to Section 7.2, "Input/Output Signals.")

### ■ Transmission/Reception Sequence of Absolute Data

When the upper level controller is ready for data reception, turn on the ABSRQ signal.

Here, you can input the ANSRQ signals through the ABSRQ bits of digital input or drive control input 2 [0x2120].

(Refer to Section 15.4, "L7C Indexer Servo Drive Transmission Address Table" for the Modbus RTU transmission address.)

When the drive receives an ABSRQ signal input, it prepares for transmission of the encoder data after a delay time of 100 [ms].

The drive transmits multi-turn data for up to 200 [ms]. The drive prepares for transmission of single-turn data for 200 [ms] from the start of multi-turn data transmission.

The drive transmits single-turn data within one revolution for up to 1200 [ms]. Here, the output data take into account the encoder output pulse count (demultiplication ratio). The data operate as normal encoder output signals 1200 [ms] after the starting point of data transmission within one revolution.

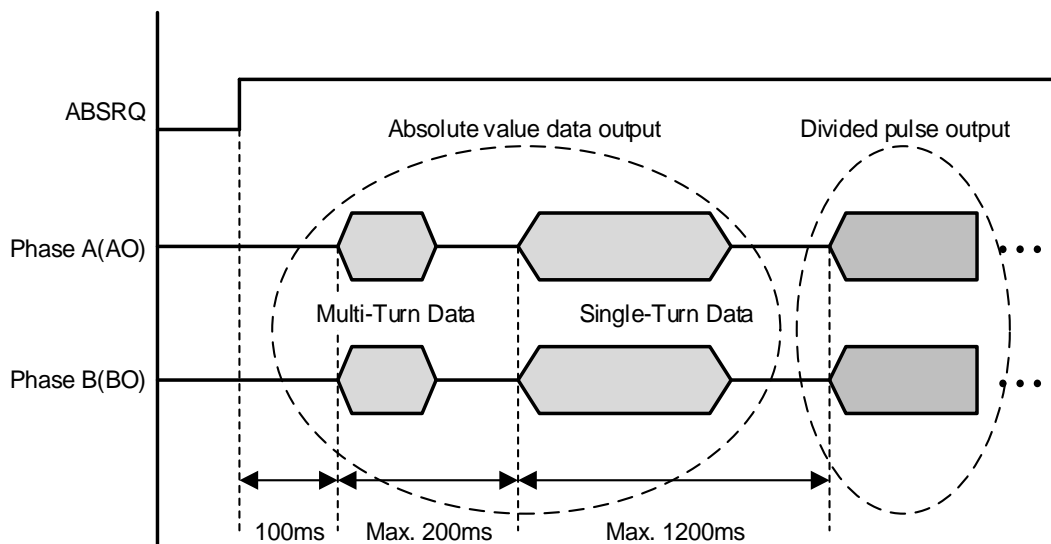

## 12. Tuning

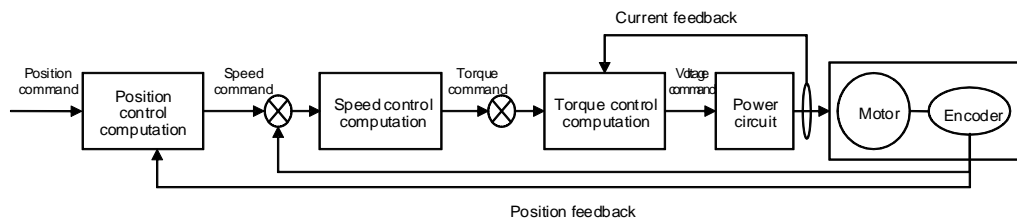

The drive is set to the torque control, velocity control, or position control mode for use, depending on the method of connecting with the upper level controller. This drive has a control structure where position control is located at the outermost part and current control at the innermost, forming a cascade. You can tune the operation according to the purpose by setting gain parameters for the torque controller, velocity controller, and position controller for the drive's operation modes.

### 12.1 Automatic Gain Adjustment (Off-Line Auto Tuning)

You can automatically set gain according to the load conditions by using the commands generated by the drive itself. The following gain parameters are changed.

- Inertia ratio, position loop gain, speed loop gain, speed integral time constant, torque command filter time constant, notch filter 3 frequency, and notch filter 4 frequency

The entire gains are set higher or lower depending on the system rigidity setting (0x250E) during gain tuning. Set the appropriate value depending on the rigidity of the load driven.

As shown in the figure below, sinusoidal type commands are generated in the forward or reverse direction according to the off-line gain tuning direction (0x2510) setting. You can set the movement distance for tuning by the off-line gain tuning distance (0x2511). Since the movement distance becomes higher as the setting value increases, it is necessary to set the distance appropriately for the situation. Make sure to secure an enough distance (higher than one revolution of the motor) prior to gain tuning.

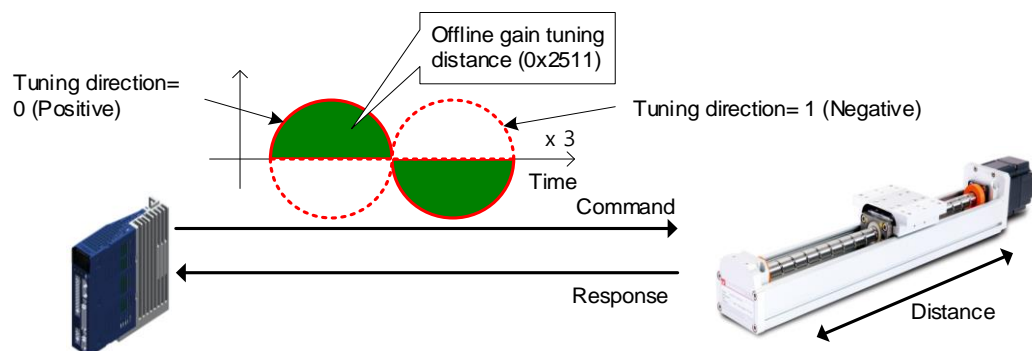

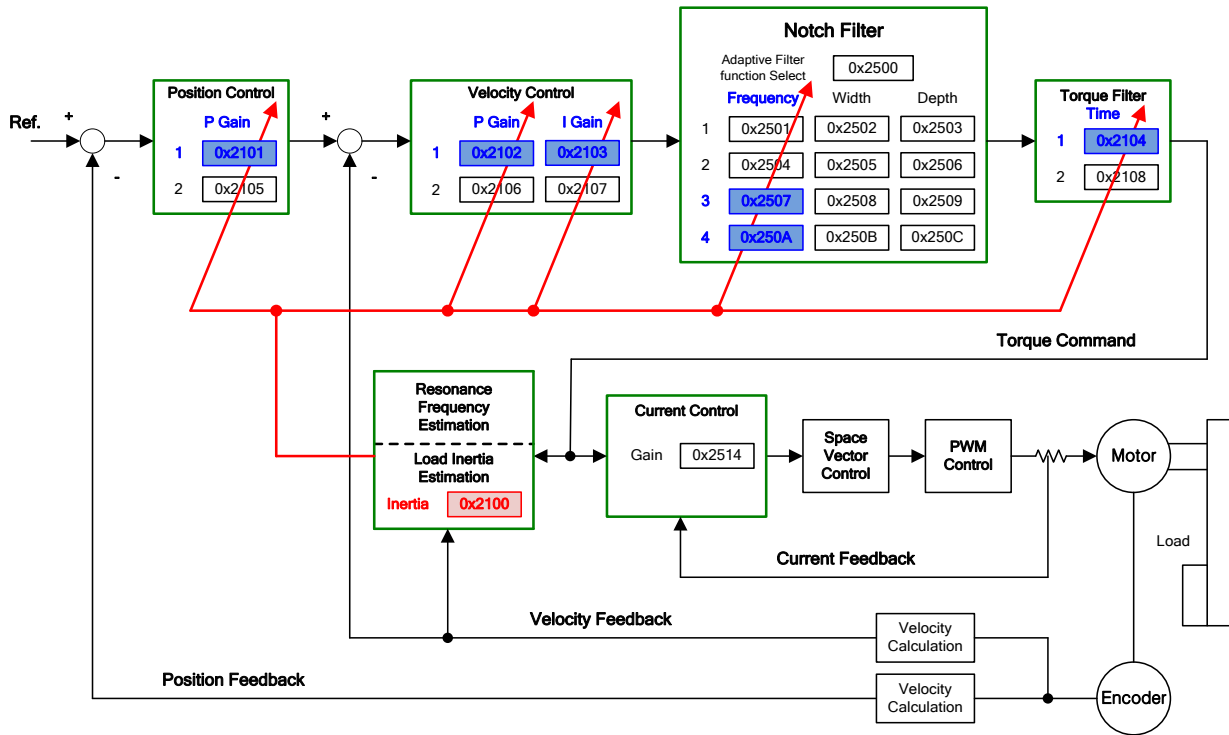

■ Related Objects

Index	Sub Index	Names	Variable Types	Accessibility	PDO Assignment	Unit
0x250E		System Rigidity for Gain Tuning	UINT	RW	No	-
0x2510	-	Off-line Gain Tuning Direction	UINT	RW	No	-
0x2511		Off-line Gain Tuning Distance	UINT	RW	No	-

## 12.2 Automatic Gain Adjustment (On-line Auto Tuning)

This is a function of automatically setting proportional gain, velocity proportional gain, speed integral time constant, and torque command filter according to the general rules and rigidity set by the user, based on estimations of the system inertia and commands received from the upper devices and not using off-line auto tuning generated by the drive itself.

- Inertia ratio, position loop gain, speed loop gain, speed integral time constant, torque command filter time constant

The function performs on-line tuning by referring to the values in the gain table in 20 levels of rigidity, regularly reflects the tuning results, and saves changed gain values every 2 minutes in EEPROM.

It can reflect the estimation values either slowly or fast according to the adaptation speed setting value, and determine the overall responsiveness of the system by using only a single rigidity setting parameter.

In the below cases, inertia ratio estimation may be incorrect by on-line auto tuning.

- Load variation is too high
- Load rigidity is too low or the system's backlash is severe
- Load is too small (lower than x3) or too big (higher than x20)
- Acceleration or deceleration is too low, resulting in insufficient acceleration/deceleration torque (lower than 10% of the rated value)
- Rotation velocity is low (lower than 10% of the rated value)
- Friction torque is high

In the above conditions or when auto-tuning does not improve operation, perform off-line gain tuning.

#### ■ Parameters Changed by Tuning

- Inertia ratio (0x2100), position loop gain 1 (0x2101), speed loop gain 1 (0x2102), speed integral time constant 1 (0x2103), torque command filter time constant 1 (0x2104)

- notch filter 3, 4 frequency (0x2507, 0x250A) → Refer to the descriptions on automatic notch setting function

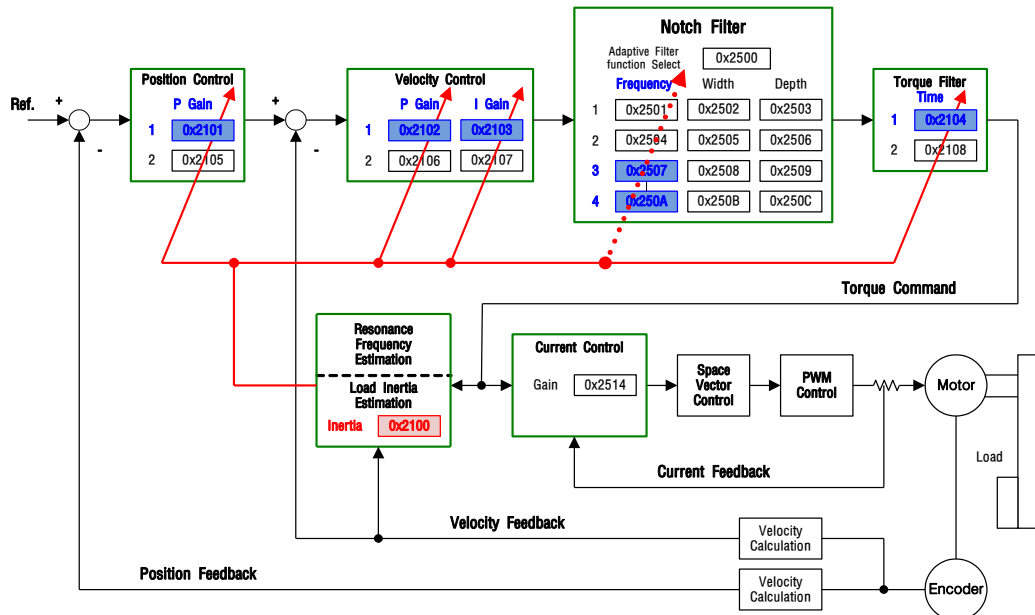

■ On-line Automatic Tuning Objects

Index	Sub Index	Name	Variable Type	Accessibility	PDO Assignment	Unit
0x250D	-	On-line Gain Tuning Mode	UINT	RW	No	-

Setting Values	Setting Details
0	On-line gain tuning not used
1	On-line gain tuning used

The factory setting is 0, which is selected when on-line automatic tuning is impossible or the gain values are already known. If you set the setting value to 1, on-line automatic tuning starts. Select this option when load inertia variation is small or when the inertia ratio is unknown. The estimated gain values from on-line automatic tuning are saved in EEPROM every 2 minutes.

■ System Rigidity Setting During On-line Automatic Tuning

Index	Sub Index	Name	Variable Type	Accessability	PDO Assignment	Unit
0x250E	-	System Rigidity for Gain Tuning	UINT	RW	No	-

There are 20 different settings for on-line automatic tuning system's rigidity, which are shown below.

If you select a system rigidity setting value, gain values (Position Loop Gain 1, Speed Loop Gain2, Speed Loop Integral Time Constant 1, Torque Command Filter Time Constant 1) are automatically determined. The factory setting value of system rigidity is 5.

Increasing the system rigidity setting value increases the gain values and shortens the positioning time. However, if the setting value is too high, vibrations may occur depending on the machine configuration. The system rigidity values need to be set from low to high values within the range in which there is no vibration.

[0x250E] System Rigidity	1	2	3	4	5	6	7	8	9	10
[0x2101] Position Loop Gain 1	2	5	10	15	22	30	40	50	60	73
[0x2102] Speed Loop Gain 1	3	8	15	23	33	45	60	75	90	110
[0x2103] Speed Loop Integral Time Constant 1	190	70	50	40	30	22	15	13	10	9
[0x2104] Torque Command Filter Time Constant 1	80	30	20	10	8	6	4	3	3	2

[0x250E] System Rigidity	11	12	13	14	15	16	17	18	19	20
[0x2101] Position Loop Gain 1	87	100	117	133	160	173	200	220	240	267
[0x2102] Speed Loop Gain 1	130	150	175	200	240	260	300	330	360	400
[0x2103] Speed Loop Integral Time Constant 1	8	7	6	6	5	5	4	4	3	3
[0x2104] Torque Command Filter Time Constant 1	2	2	2	2	1	1	1	1	1	1

#### ■ On-line Gain Tuning Adaptation Speed During On-line Automatic Tuning

Index	Sub Index	Name	Variable Type	Access ibility	PDO Assignment	Unit
0x250F	-	On-line Gain Tuning Adaptation Speed	UINT	RW	No	-

This specifies the speed of reflecting gain changes from on-line automatic tuning. The larger the setting value is, the faster the gain changes are reflected.

## 12.3 Manual Gain Tuning

### 12.3.1 Gain Tuning Sequence

For a cascade-type controller, tune the gain of the velocity controller located at an inner position first, then tune the gain of the position controller located at an outer position.

In other words, perform tuning in the order of proportional gain → integral gain → feedforward gain.

The role of each individual gain is as follows.

- Proportional gain: Determines controller BW
- Integral gain: Determines error of the steady state and generates an overshoot
- Feedforward gain: Enhances on the system lag characteristic
- Differential gain: Plays the role of a damper for the system (not provided)

#### ■ Speed Controller Tuning

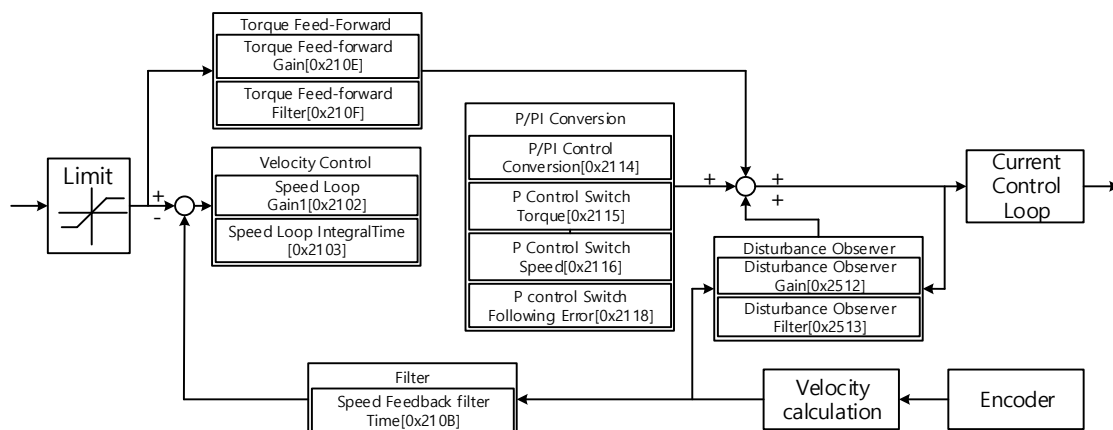

#### (1) Inertia ratio setting

- Use the automatic inertia estimation function or carry out manual setting

#### (2) Proportional gain setting

- Monitor for torque and noise before any vibration occurs



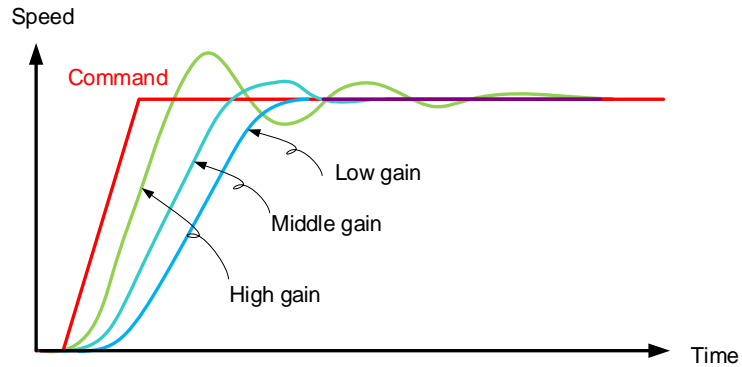

- The higher the speed proportional gain value, the feedback speed's responsiveness to the command speed becomes better. However, if the value is too high, an overshoot or ringing may occur. In contrast, if the value is too low, the responding speed becomes low, which slows down system operation.

### (3) Integral gain setting

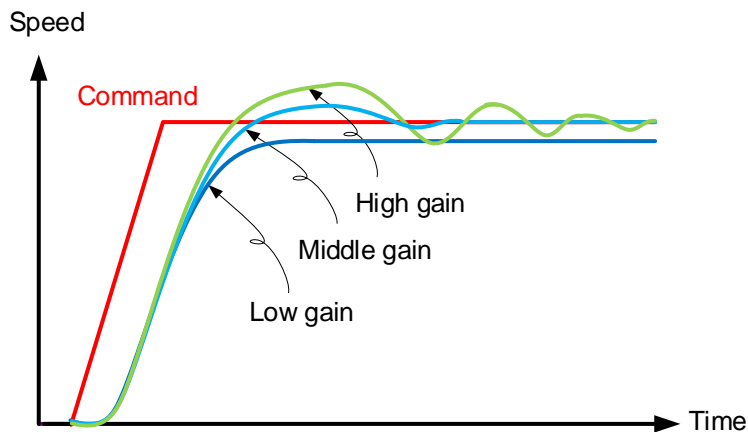

- The value and the responsiveness have an inverse proportion relationship where a higher value results in a lower responding speed. Too high of the integral gain increases the overshoot. In this case, P/PI conversion can manage the overshoot.

## ■ Position Controller Tuning

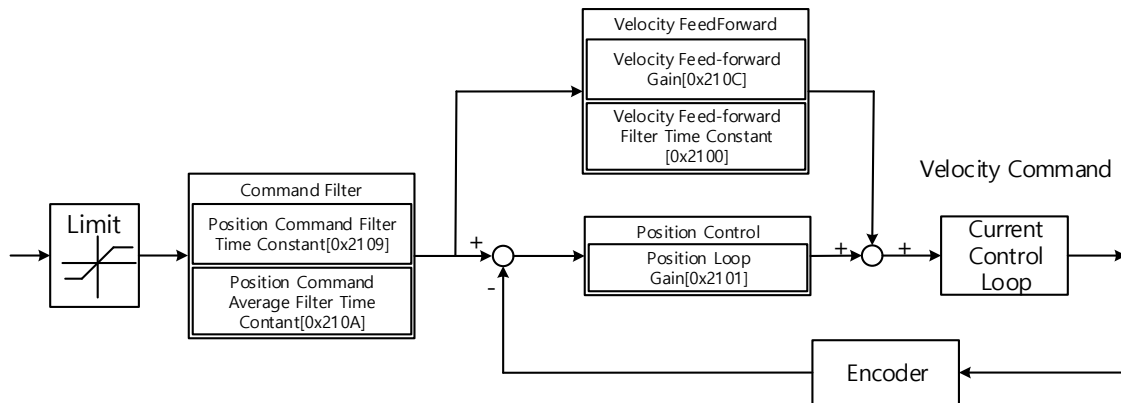

### (1) Proportional gain setting

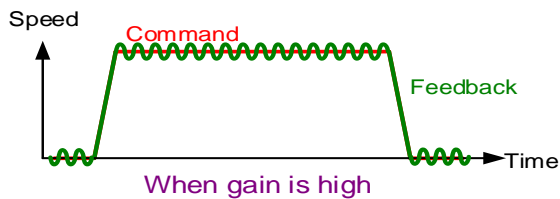
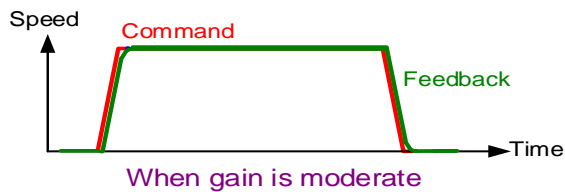
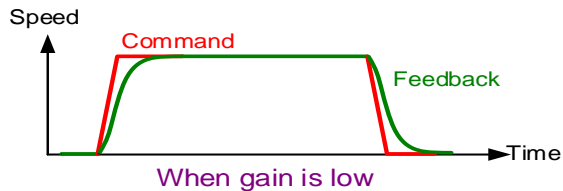

- The error between the position command and the current position is multiplied by the proportional gain, and the result is converted to a velocity command. The higher the gain, the better the responsiveness of position control. In many cases, a value that is 0.2~0.5 times of the speed proportional gain is applied for a stable structure.

### (2) Feedforward setting

- Positional error monitoring
- Feedforward filter setting possible
- Set the filter if you want to increase the feedforward value but noise occurs.
- You can set feedforward to a value from 0% to 100%, which is the deviation ratio of the position command value being entered currently.

### (3) Position command filter setting possible

- You can smooth a position command. As the value increases, the position operation is shaped into an S curve and reduces shock waves such as Jerk.

## 12.4 Vibration Control

### 12.4.1 Notch Filter

The notch filter is a sort of band stop filter that eliminates specific frequency components. You can use a notch filter to eliminate resonant frequency components of an apparatus, which allows vibration avoidance and higher gain setting.

This drive provides notch filters in 4 levels, and you can set frequency, width, and depth for each filter. You can use one or two notch filters as adaptive filters, which set the frequency and width automatically through real-time frequency analysis (FFT).

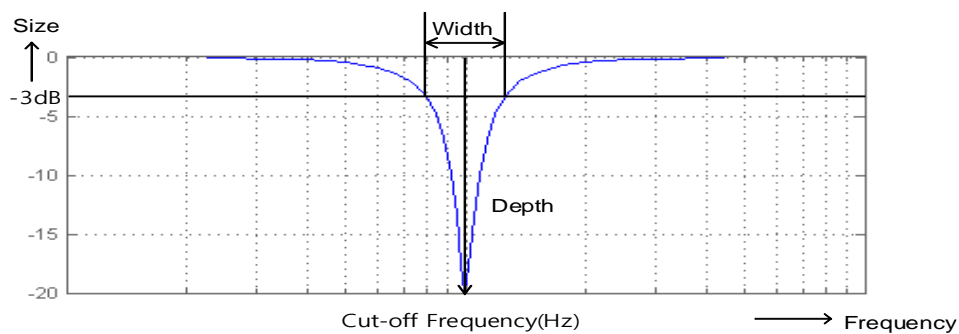

#### ■ Related Objects

Index	Sub Index	Names	Variable Types	Accessibility	PDO Assignment	Unit
0x2501	-	Notch Filter 1 Frequency	UINT	RW	No	Hz
0x2502	-	Notch Filter 1 Width	UINT	RW	No	Hz
0x2503	-	Notch Filter 1 Depth	UINT	RW	No	-
0x2504	-	Notch Filter 2 Frequency	UINT	RW	No	Hz
0x2505	-	Notch Filter 2 Width	UINT	RW	No	Hz
0x2506	-	Notch Filter 2 Depth	UINT	RW	No	-
0x2507	-	Notch Filter 3 Frequency	UINT	RW	No	Hz
0x2508	-	Notch Filter 3 Width	UINT	RW	No	Hz
0x2509	-	Notch Filter 3 Depth	UINT	RW	No	-
0x250A	-	Notch Filter 4 Frequency	UINT	RW	No	Hz
0x250B	-	Notch Filter 4 Width	UINT	RW	No	Hz
0x250C	-	Notch Filter 4 Depth	UINT	RW	No	-

## 12.4.2 Adaptive Filter

Using speed feedback signals, the adaptive filter provides real-time analyses of the vibration frequency generated from the load during drive operation, and configures the notch filter automatically to reduce vibration.

It can detect vibration frequencies through frequency analysis in order to automatically configure one or two notch filters. Here, the frequencies and their widths are automatically set and the setting values for the depths are used unchanged.

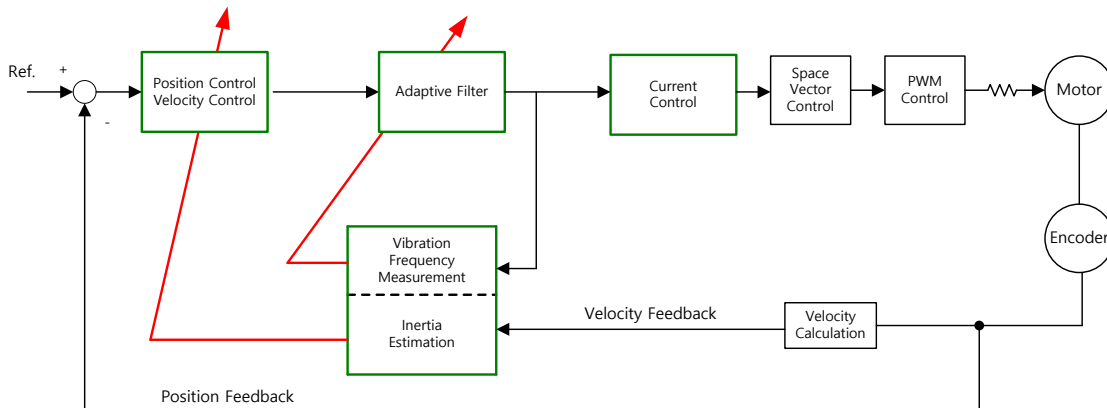

### ■ Related Objects

Index	Sub Index	Name	Variable Type	Accessibility	PDO Assignment	Unit
0x2500	-	Adaptive Filter Function Select	UINT	RW	No	-

- Adaptive Filter Function Setting (0x2500)

Any setting value other than 1 or 2 is reset to 0.

Setting Values	Setting Details
0	The adaptive filter is not used
1	Only one adaptive filter is used. You can check the automatic settings in the notch filter 4 settings (0x250A, 0x250B).
2	Only two adaptive filters are used. You can check the automatic settings in the notch filter 3 (0x2507, 0x2508) and 4 settings (0x250A, 0x250B).
3	Reserved
4	Resets the settings of notch filter 3 (0x2507, 0x2508) and notch filter 4 (0x250A, 0x250B, 0x250C)
5	Reserved

## 12.4.3 Vibration Suppression Filter

The vibration suppression filter is a function used to reduce vibration generated in the load side.

It measures the vibration frequency in the load side using an external sensor, and uses the measurement as object data for the filter. This drive provides a vibration suppression filter in two levels, and you can set the frequency and fluctuation for each filter.

It controls the lower frequency range, i.e. 1 [Hz]~100 [Hz], from the upper part of the device or the entire system, and operates only in the position control mode.

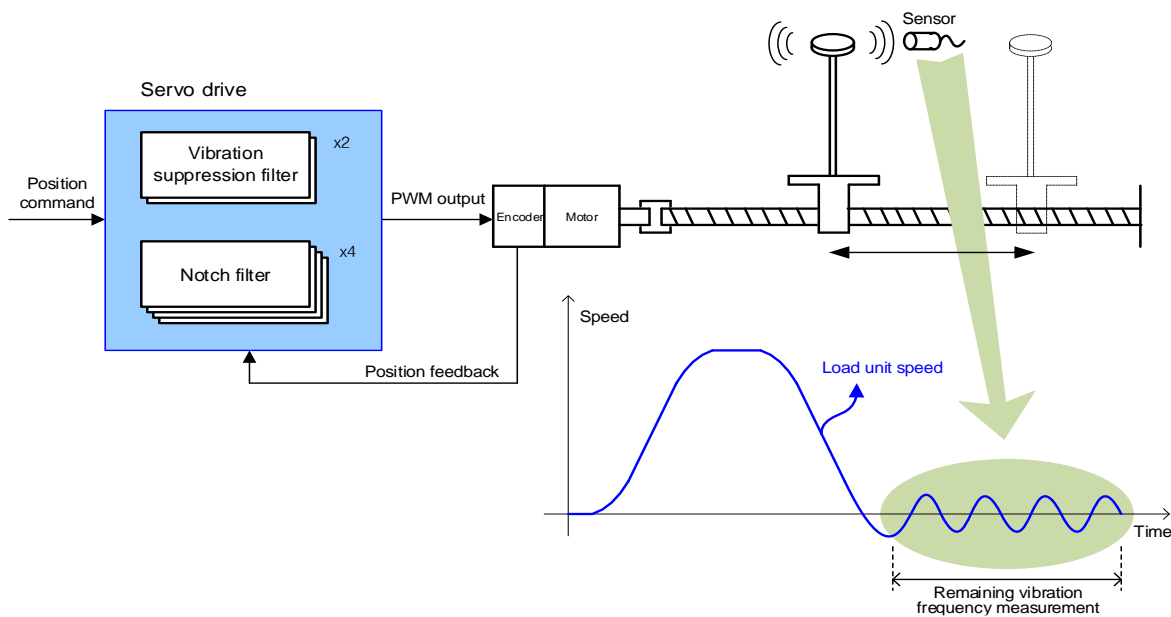

### ■ Related Objects

Index	Sub Index	Names	Variable Types	Accessibility	PDO Assignment	Unit
0x2515	-	Vibration Suppression Filter Configuration	UINT	RW	No	-
0x2516	-	Vibration Suppression Filter 1 Frequency	UINT	RW	No	0.1[Hz]
0x2517	-	Vibration Suppression Filter 1 Damping	UINT	RW	No	-
0x2518	-	Vibration Suppression Filter 2 Frequency	UINT	RW	No	0.1[Hz]
0x2519	-	Vibration Suppression Filter 2 Damping	UINT	RW	No	-

#### ■ Vibration Suppression Filter Function Setting (0x2515)

Setting Values	Setting Details
0	The vibration suppression filter is not used
1	The vibration suppression filters 1 and 2 are applied
2	The vibration suppression filters 1 and 2 are applied according to LVSF1 and LVSF2 input.



# 13. Procedure Function

Procedure function is an auxiliary function provided by the drive as described below. It can be executed by the procedure command code (0x2700) and procedure command factor (0x2701). It can be activated by using the servo setting tool.

Procedure commands	Codes	Details
Manual JOG	0x0001	Operates manual JOG
Program JOG	0x0002	Operates program JOG
Alarm History Reset	0x0003	Deletes alarm history
Off-Line Auto-Tuning	0x0004	Performs off-line auto-tuning
Index Pulse Search	0x0005	Searches for phase Z position
Absolute Encoder Reset	0x0006	Resets the absolute encoder
Max. Load Torque Clear	0x0007	Resets the instantaneous maximum operation overload (0x2604) value
Calibrate Phase Current Offset	0x0008	Performs phase current offset tuning
Software Reset	0x0009	Resets the software
Commutation	0x000A	Performs commutation

## 13.1 Manual Jog Operation

Jog operation is a function that verifies servo motor operation by velocity control without an upper level controller.

Before starting jog operation, confirm the following.

- The main power is turned on
- No alarm is active
- The servo is turned off
- The operation velocity is set in consideration of the state of the apparatus

### ■ Related Objects

Index	Sub Index	Names	Variable Types	Accessibility	PDO Assignment	Units
0x2300	-	Jog Operation Speed	INT	RW	No	rpm
0x2301	-	Speed Command Acceleration Time	UINT	RW	No	ms
0x2302	-	Speed Command Deceleration Time	UINT	RW	No	ms
0x2303	-	Speed Command S-curve Time	UINT	RW	No	ms

## 13.2 Program Jog Operation

Program jog operation is a function that verifies servo motor operation by velocity control at predefined operation velocity and time without an upper level controller.

Before starting jog operation, confirm the following.

- The main power is turned on
- No alarm is active
- The servo is turned off
- Velocity and time are set in consideration of the state and operation range of the apparatus

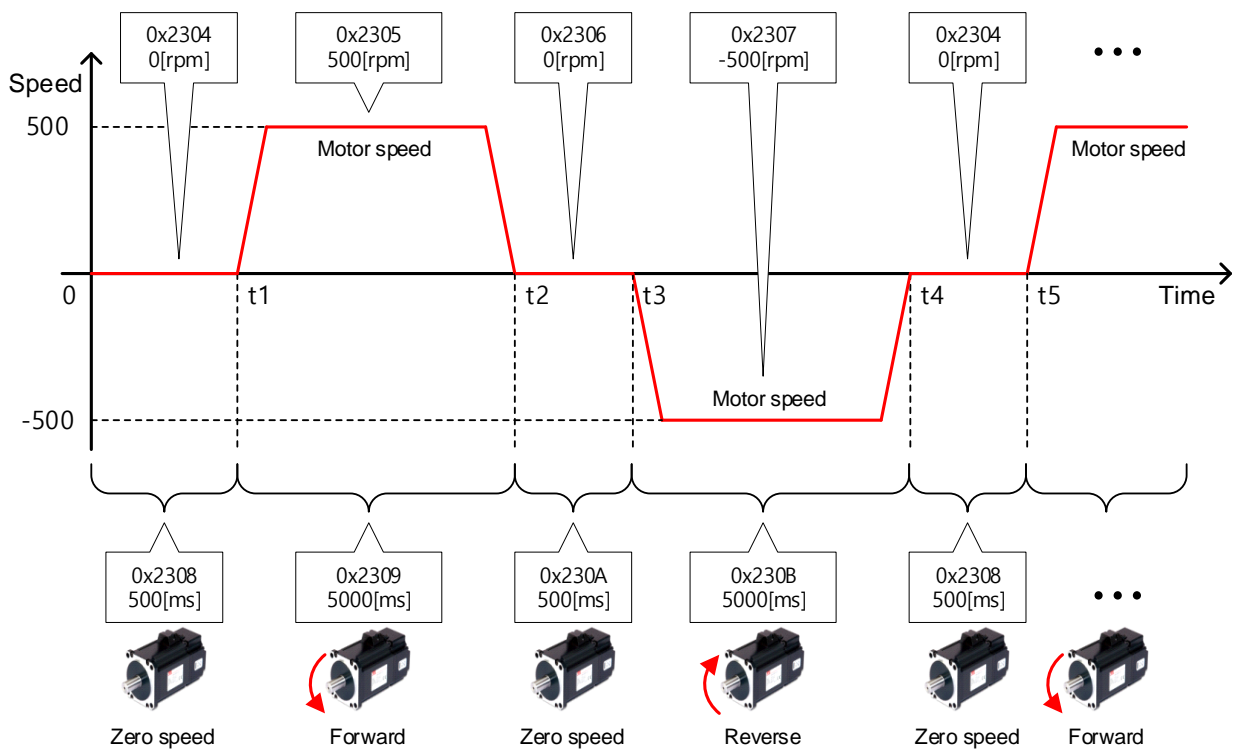

### ■ Related Objects

Index	Sub Index	Names	Variable Types	Accessibility	PDO Assignment	Units
0x2304	-	Program Jog Operation Speed 1	INT	RW	No	rpm
0x2305	-	Program Jog Operation Speed 2	INT	RW	No	rpm
0x2306	-	Program Jog Operation Speed 3	INT	RW	No	rpm
0x2307	-	Program Jog Operation Speed 4	INT	RW	No	rpm
0x2308	-	Program Jog Operation Time 1	UINT	RW	No	ms
0x2309	-	Program Jog Operation Time 2	UINT	RW	No	ms



0x230A	-	Program Jog Operation Time 3	UINT	RW	No	ms
0x230B	-	Program Jog Operation Time 4	UINT	RW	No	ms

## 13.3 Deleting Alarm History

This function deletes all the alarm code histories stored in the drive. Alarm histories including the latest alarm history up to the 16th previous alarm are stored.

You can check the histories as shown below (0x2702:01~16). The latest alarm is listed in 0x2702:01.

2702:0	Servo Alarm History	RO	> 16 <
2702:01	Alarm code 1(Newest)	RO	[51]POS following
2702:02	Alarm code 2	RO	[51]POS following
2702:03	Alarm code 3	RO	[51]POS following
2702:04	Alarm code 4	RO	[51]POS following
2702:05	Alarm code 5	RO	[51]POS following
2702:06	Alarm code 6	RO	[51]POS following
2702:07	Alarm code 7	RO	[51]POS following
2702:08	Alarm code 8	RO	[51]POS following
2702:09	Alarm code 9	RO	[51]POS following
2702:0A	Alarm code 10	RO	[51]POS following
2702:0B	Alarm code 11	RO	[51]POS following
2702:0C	Alarm code 12	RO	[51]POS following
2702:0D	Alarm code 13	RO	[51]POS following
2702:0E	Alarm code 14	RO	[51]POS following
2702:0F	Alarm code 15	RO	[51]POS following
2702:10	Alarm code 16(Oldest)	RO	[51]POS following

### ■ Related Objects

Index	Sub Index	Names	Variable Types	Accessibility	PDO Assignment	Units
	-	Servo Alarm History	-	-	-	-
0x2702	1	Alarm Code 1 (Newest)	STRING	RO	No	-
	2	Alarm Code 2	STRING	RO	No	-
	3	Alarm Code 3	STRING	RO	No	-
	4	Alarm Code 4	STRING	RO	No	-
	5	Alarm Code 5	STRING	RO	No	-
	6	Alarm Code 6	STRING	RO	No	-
	7	Alarm Code 7	STRING	RO	No	-
	8	Alarm Code 8	STRING	RO	No	-
	9	Alarm Code 9	STRING	RO	No	-

10	Alarm Code 10	STRING	RO	No	-
11	Alarm Code 11	STRING	RO	No	-
12	Alarm Code 12	STRING	RO	No	-
13	Alarm Code 13	STRING	RO	No	-
14	Alarm Code 14	STRING	RO	No	-
15	Alarm Code 15	STRING	RO	No	-
16	Alarm code 16(Oldest)	STRING	RO	No	-

## 13.4 Automatic Gain Tuning

For more information, refer to Section 11.1, “Automatic Gain Tuning.”

## 13.5 Index Pulse Search

Index pulse search is a function used to find the index (Z) pulse position of the encoder and bring the index to a stop. You can use this function to roughly locate a position since it searches for a position using the Velocity Mode. To locate exact positions of the index pulse, use homing operation.

You can set the velocity used to search for index pulses in 0x230C [rpm].

Before starting index pulse search, confirm the following.

- The main power is turned on
- No alarm is active
- The servo is turned off
- Operation velocity is set in consideration of the operation range of the machine.

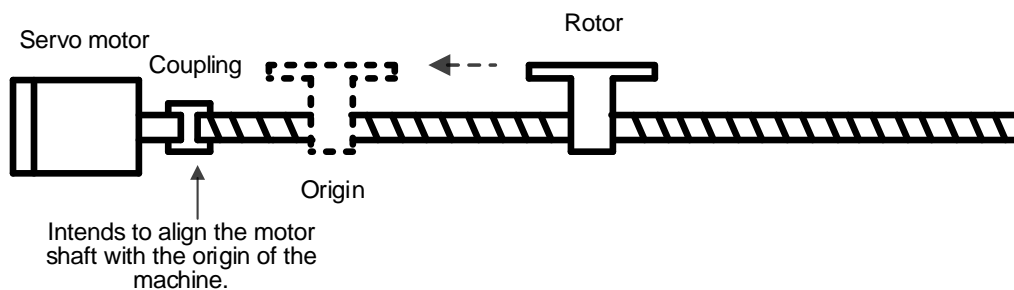

## ■ Related Objects

Index	Sub Index	Name	Variable Type	Accessibility	PDO Assignment	Unit
0x230C	-	Index Pulse Search Speed	INT	RW	No	rpm

## 13.6 Absolute Encoder Reset

This function resets the absolute encoder. The following are the situations where you need to reset the absolute encoder.

- To set up the apparatus for the first time
- When an alarm occurs for low voltage of the encoder
- To set multi-turn data of the absolute encoder to 0

When the absolute encoder reset is completed, the multi-turn data (0x260A) and the single-turn data (0x2607) are reset to 0. After the reset, turn on the power again to change the position actual value (0x262A) to the reset value.

When the power is turned on again, the position actual value (0x262A) reads the position of the absolute encoder and displays the value by applying the home offset (0x3019). Here, even if the home offset (0x3019) is changed during operation, the position actual value (0x262A) remains unchanged.

## ■ Related Objects

Index	Sub Index	Names	Variable Types	Accessibility	PDO Assignment	Units
0x2005	-	Absolute Encoder Configuration	UINT	RW	No	-
0x2607		SingleTurn Data	UDINT	RO	Yes	pulse
0x260A		MultiTurn Data	DINT	RO	Yes	rev

## 13.7 Instantaneous Maximum Torque Reset

This function resets the instantaneous maximum overload rate (0x2604) to 0. The instantaneous maximum operation overload rate represents the maximum value of the operation overload rate output instantaneously from the drive.

It displays the maximum (peak) load between the time when the servo is turned on and the current time in percentage in relation to the rated output. The unit is [0.1%]. Turning on the power again resets the value to 0.

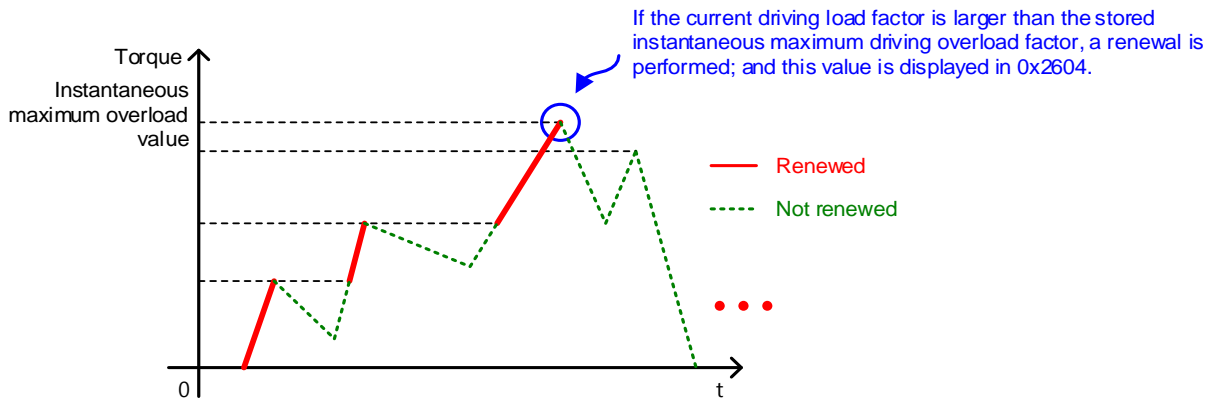

### ■ Related Objects

Index	Sub Index	Name	Variable Type	Accessibility	PDO Assignment	Unit
0x2604	-	Instantaneous Maximum Operation Overload	INT	RO	Yes	0.1%

## 13.8 Phase Current Offset Tuning

This function automatically tunes the current offset of the U/V/W phases. You can tune the phase current offset according to the environmental condition for use. The device is shipped with its factory default setting.

The measured U/V/W-phase offsets are individually stored in 0x2015, 0x2016, and 0x2017. If an offset value is abnormally large, AL-15 is generated.

### ■ Related Objects

Index	Sub Index	Names	Variable Types	Accessibility	PDO Assignment	Unit
0x2015	-	U Phase Current Offset	INT	RW	No	0.1%
0x2016	-	V Phase Current Offset	INT	RW	No	0.1%
0x2017	-	W Phase Current Offset	INT	RW	No	0.1%

## 13.9 Software Reset

This function is used to reset the servo drive by means of software. Software reset means a restart of the drive program, which results in an effect similar to re-applying the power.

You can use this function in the following cases.

- Parameter settings which require re-application of the power have been changed
- The drive needs a re-start due to an alarm which cannot be reset

## 13.10 Commutation

The commutation function is used to get the information of the initial angle of the motor. When using a motor with the hall sensor not installed, you have to get the information on the initial angle through commutation prior to operation, in order to carry out normal operation.

### ■ Related Objects

Index	Sub Index	Names	Variable Types	Accessibility	PDO Assignment	Units
0x2019	-	Linear Scale Resolution	UINT	RW	No	nm
0x201A	-	Commutation Method	UINT	RW	No	-
0x201B	-	Commutation Current	UINT	RW	No	0.1%
0x201C	-	Commutation Time	UINT	RW	No	ms



# 14. Object Dictionary

Object is a data structure which includes parameters, state variables, run commands (procedures), etc. of the drive.

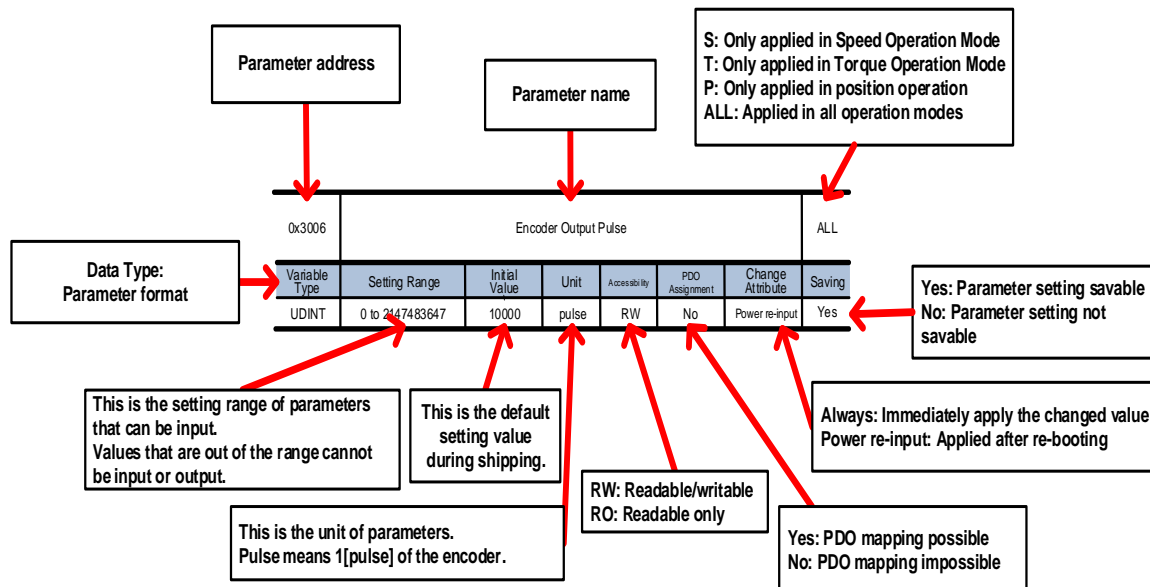

Parameters are categorized into immediately applied ones and ones that can be applied only if the servo power is turned on/off. The above table provides an example of the variable attributes.

## <Caution>

- When turning off the power in order to change parameters, L7C takes a long time to completely block the power source (to turn off the segment display).
- Here, to apply the changed parameters, do not wait until the power source is completely blocked, but simply turn on the power again for a reboot after the setting time in Main Power Fail Check Time[0x2007] +1.5 seconds.
- If you change the parameters which over 0x3000 by using DriveCM, please change the value after 6[sec] at index o object dictionary.(DriveCM need more time due to reading parameters over 0x3000 at object dictionary.)

## 14.1 Data Type

The following table outlines the data types and ranges used in this manual.

Codes	Description	Ranges
SINT	Signed 8-bit	-128~127
USINT	Unsigned 8-bit	0~255
INT	Signed 16-bit	-32768~32767
UINT	Unsigned 16-bit	0~65535
DINT	Signed 32-bit	-21247483648~21247483647
UDINT	Unsigned 32-bit	0~4294967295
FP32	Float 32-bit	Single precision floating point
STRING	String Value	



## 14.2 Basic Setting (0x2000~)

0x2000	Motor ID						ALL
Variable Type	Setting Range	Initial Value	Unit	Accessibility	PDO Assignment	Variable Attribute	Saving
UINT	1 to 9999	13	-	RW	No	Power re-input	Yes

This is a parameter for resetting the motor ID. The company supplies a motor with a default ID and ID input is also possible.

Encoder Type	Motor ID Input Method
Incremental	Direct input
Absolute Singleturn	Automatic recognition
Absolute Multiturn	Automatic recognition

For a motor supplied by the company, you can enable automatic recognition or input a motor ID into the parameter. Motor IDs are provided on the sticker attached on a side of the motor.

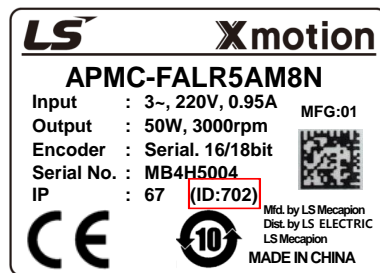

Absolute Multiturn  
(18Bit Singleturn / 16Bit Multiturn)

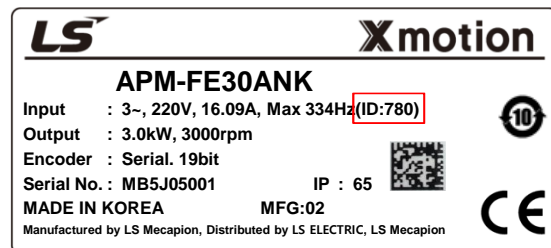

Absolute Singleturn  
(19Bit Singleturn)

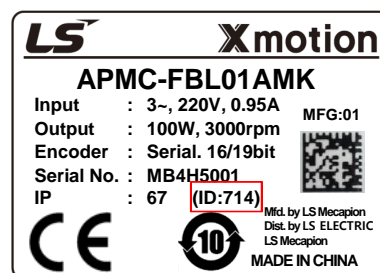

Absolute Multiturn  
(19Bit singleturn / 16Bit Multiturn)

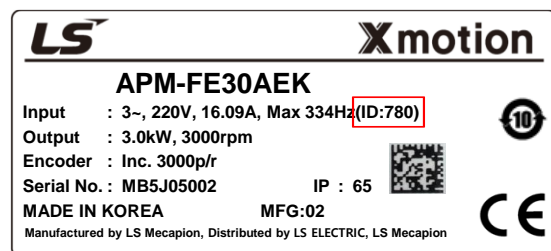

Incremental  
(3000[ppr] Incremental)

Keep in mind that you need to re-supply the power after ID registration. When connecting a motor of another brand, you have to input 9999 and make the setting to 3rd party.

0x2001	Encoder Type						ALL
Variable Type	Setting Range	Initial Value	Unit	Accessibility	PDO Assignment	Variable Attribute	Saving
UINT	0 to 2	1	-	RW	No	Power re-input	Yes

You can set the encoder type. Set it correctly by referencing the table below. Here, the serial encoder provided by our company (3 in the table below) is automatically recognized and set regardless of these settings. You can view the type of the encoder automatically recognized.

Setting Values	Encoder Types
0	Quadrature (Incremental, A lead B)
1	BiSS Serial Absolute (Multi-turn 16-bit)
2	BiSS Serial (Single-turn only)

You can view the encoder type on the name plate attached on the motor. Refer to Section 1.1, "Product Specifications" for the product type of the servo motor.

0x2002	Encoder Pulse per Revolution						ALL
Variable Type	Setting Range	Initial Value	Unit	Accessibility	PDO Assignment	Variable Attribute	Saving
UDINT	1 to 1073741824	524288	pulse	RW	No	Power re-input	Yes

This is a parameter for setting the resolution of the encoder. Set the encoder resolution in the unit of pulse (count) and in multiples of 4. The absolute encoder and single-turn encoder provided by the company recognize the values automatically. However, for the incremental encoder, you need to input the values yourself.

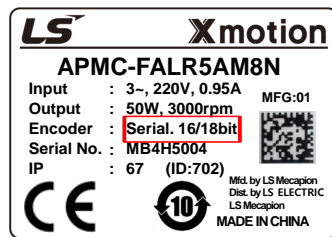

Absolute Multiturn  
(18Bit Singleturn / 16Bit Multiturn)



Absolute Singleturn  
(19Bit Singleturn)

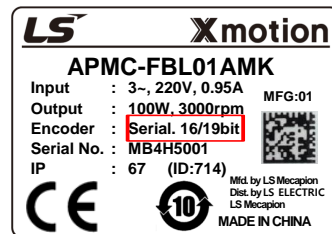

Absolute Multiturn  
(19Bit singleturn / 16Bit Multiturn)

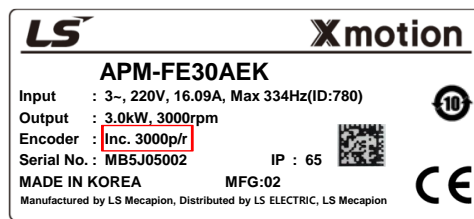

Incremental  
(3000[ppr] Incremental)

The encoder resolution values are provided on the sticker on a side of the motor. Refer to the figures above.

Encoder Types	Input Methods	Input Examples
Incremental	Direct input	Input 8192 if it shows 2048p/r on the sticker on the motor's side
Absolute Singleturn	Automatic recognition	No input necessary for automatic recognition Possible to view the automatic input of 524288
Absolute Multiturn	Automatic recognition	No input necessary for automatic recognition Possible to view the automatic input of 524288

0x2003	Node ID						ALL
Variable Type	Setting Range	Initial Value	Unit	Accessibility	PDO Assignment	Variable Attribute	Saving
UINT	1 to 99	1	-	RW	No	Power re-input	Yes

You can set the node ID of the driver. Any setting value modified after node setting is reflected only when the power is turned on again.

0x2004	Rotation Direction Select						ALL
Variable Type	Setting Range	Initial Value	Unit	Accessibility	PDO Assignment	Variable Attribute	Saving
UINT	0 to 1	0	-	RW	No	Power re-input	Yes

You can set the rotation direction of the motor. You can change the rotation direction with this setting between the positive and negative relative to the user in the final apparatus section.

Setting Values	Description
0	With a command for the positive direction, the motor rotates counterclockwise. Here, the position feedback value increases.
1	With a command for the positive direction, the motor rotates clockwise. Here, the position feedback value increases.

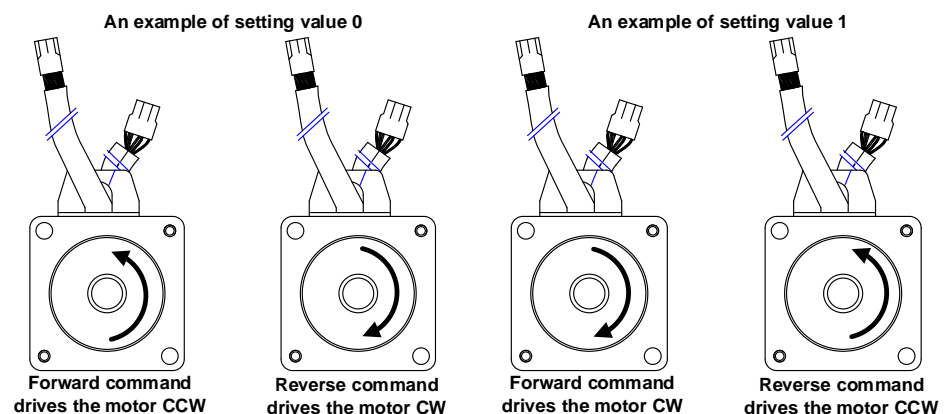

0x2005	Absolute Encoder Configuration						ALL
Variable Type	Setting Range	Initial Value	Unit	Accessibility	PDO Assignment	Variable Attribute	Saving
UINT	0 to 2	1	-	RW	No	Power re-input	Yes

This is parameter for deciding whether or not to use multi-turn data when using the absolute multi-turn encoder.

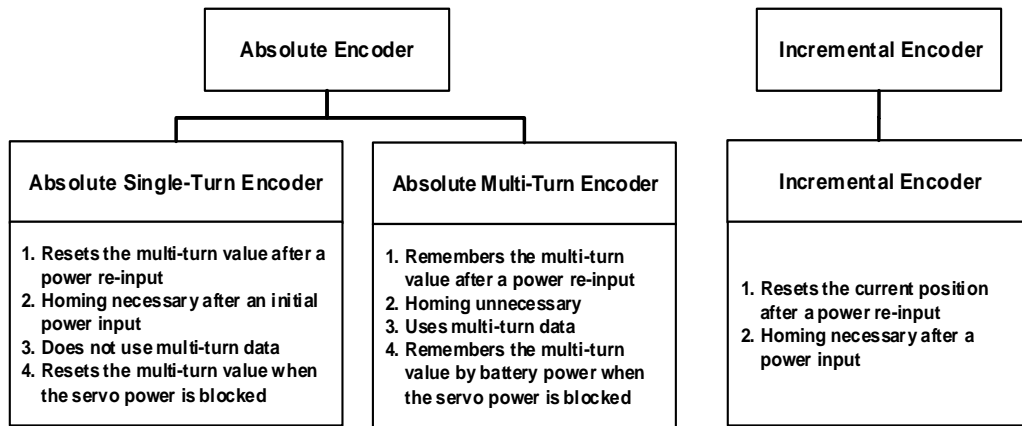

Setting Values	Description
0	Uses multi-turn data of the absolute encoder. When the encoder type [0x2001] setting value is 1, it displays the single turn and multiturn encoder values in Position Actual Value during power on/off.
1	Does not use multi-turn data of the absolute encoder. Displays Position Actual Value as 0 during power on/off.
2	Uses singleturn of the absolute encoder. When the encoder type [0x2001] setting value is 1, it displays the encoder's singleturn values in Position Actual Value during power on/off.

When you set the parameter to 0, the values of multiturn and the current position are maintained even when the power is turned off and on. However, if you set it to 1, the values of multiturn and the current position are all reset when the power is re-supplied.

For Absolute Single-Turn Encoder setting 1:

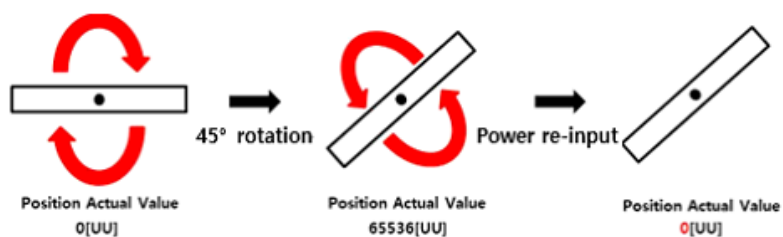

For Absolute Single-Turn Encoder setting 0:

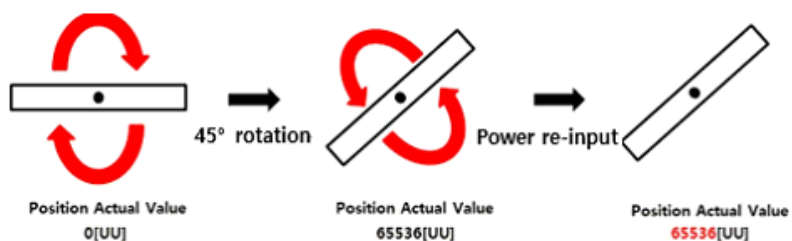

When you set the value to 2, power re-supply resets the multiturn value to 0[revolution] but brings the encoder's singleturn value for the current position and displays it.

#### ⚠ Caution

- If you replace the motor and encoder cable while using an absolute encoder, or replace the battery with the servo power turned off, the encoder's multi-turn data will be lost.
- If the encoder loses multi-turn data, there is a risk of equipment malfunction and accident, so be sure to perform origin operation before driving

0x2006	Main Power Fail Check Mode						ALL
Variable Type	Setting Range	Initial Value	Unit	Accessibility	PDO Assignment	Variable Attribute	Saving
UINT	0 to 255	0	-	RW	No	Always	Yes

You can set the main power input mode and the processing method for phase loss.

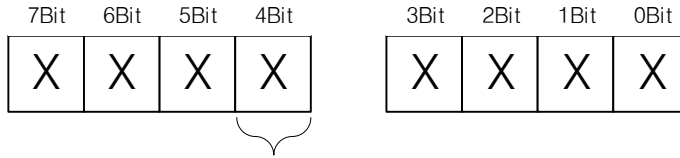

Value	Setting details
0	Processed as AL-42 after a main power phase loss
1	Processed as W-01 after a main power phase loss

The 4th bit determines the servo's state in the event of a phase loss of the main power.

Main Power Fail Check Mode[0x2006]	Single-phase input
0x00	Servo On
0x10	Servo On

<Servo status immediately after servo on>

For example, if you input '0x10' for the parameter, apply the single-phase power, and input a servo on command, the servo is turned on. When the main power is disconnected, the motor issues a Warn-01 and stops.

Main Power Fail Check Mode[0x2006]	When the main power is blocked during operation after servo on
0x00	AL-42
0x10	W-01 occurrence&motor stop

<Servo status immediately after power block in servo on>

However, if you apply the main power within Main Power Fail Check Time [0x2007] + 1.5 [sec] (approx. 2 [sec]), it is possible to switch the state from Warning to Servo On. Inputting another command brings back the normal operation.

If you input 0x00, disconnecting the power after Servo On immediately causes AL-42 to occur.

0x2007	Main Power Fail Check Time						ALL
Variable Type	Setting Range	Initial Value	Unit	Accessibility	PDO Assignment	Variable Attribute	Saving
UINT	0 to 5000	20	ms	RW	No	Always	Yes

You can set the checking time for main power phase loss. This function detects instantaneous voltage drop, which may occur depending on the condition of external power input, to check for the main power's phase loss. Set this function properly according to the condition of external power input.

0x2008	7SEG Display Selection						ALL
Variable Type	Setting Range	Initial Value	Unit	Accessibility	PDO Assignment	Variable Attribute	Saving
UINT	0 to 100	0	-	RW	Yes	Always	Yes

You can set items to display in the 7SEG window.

Setting Values	Displayed Items	Units	Description
0	Operation status	-	
1	Speed feedback	rpm, mm/s	
2	Velocity command	rpm, mm/s	
3	Torque feedback	0.1%	
4	Torque command	0.1%	
5	Accumulated operation overload	0.1%	
6	DC link voltage	V	
7	Accumulated regeneration overload	0.1%	
8	Mechanical angle	0.1 deg	
9	Electrical angle	0.1 deg	
10	Inertia ratio	%	
11	Drive temperature 1	°C	Temperature near drive power element
12	Drive temperature 2	°C	Internal temperature of the drive
13	Encoder temperature 1	°C	Internal temperature of the encoder
14	Node ID	-	
15	Instantaneous maximum load factor	0.1%	Instantaneous maximum load factor for 15 seconds
16	Actual load factor(RMS)	0.1%	Actual load factor(RMS) for 15 seconds
17	Current position value	-	

0x2009	Regeneration Brake Resistor Configuration						ALL
Variable Type	Setting Range	Initial Value	Unit	Accessibility	PDO Assignment	Variable Attribute	Saving
UINT	0 to 1	1	-	RW	No	Always	Yes

You can make settings related to regenerative resistance.

Setting Values	Description
0	You can set the following resistance capacity and resistance values according to drive capacity. 400W or lower: 80W/40Ω 750W, 1.0kW: 50W/40Ω
1	Uses a regenerative resistance separately installed outside the drive. Ensure that resistance (0x200B) and capacity (0x200C) of the regenerative resistance are set correctly. For wiring of the external regenerative resistance, refer to the wiring diagram in Section 2.3, "Main Power Wiring"

0x200A	Regeneration Brake Resistor Derating Factor						ALL
Variable Type	Setting Range	Initial Value	Unit	Accessibility	PDO Assignment	Variable Attribute	Saving
UINT	0 to 200	100	%	RW	No	Always	Yes

You can set the derating factor for regenerative resistance overload checkups. When the derating factor is set to a value of 100 [%] or lower, the regeneration overload alarm (AL-23) is triggered quickly. When it is set to a value higher than 100 [%], the alarm is triggered slowly. Change the setting values according to the heat radiation condition of the regenerative resistance used. You must consider the heat radiation condition with more care when you set the derating factor to a value higher than 100%.

0x200B	Regeneration Brake Resistor Value						ALL
Variable Type	Setting Range	Initial Value	Unit	Accessibility	PDO Assignment	Variable Attribute	Saving
UINT	0 to 1000	0	Ohm	RW	No	Always	Yes

When using an external regenerative resistance (0x2009=1), set regenerative resistance in the unit of ohm. When using an internal regenerative resistance (0x2009= 0), the setting value does not apply.



0x200C	Regeneration Brake Resistor Power						ALL
Variable Type	Setting Range	Initial Value	Unit	Accessibility	PDO Assignment	Variable Attribute	Saving
UINT	0 to 30000	0	Watt	RW	No	Always	Yes

When using an external regenerative resistance (0x2009=1), set regenerative resistance capacity in the unit of watt. When using an internal regenerative resistance (0x2009= 0), the setting value does not apply.

0x200D	Peak Power of Regeneration Brake Resistor						ALL
Variable Type	Setting Range	Initial Value	Unit	Accessibility	PDO Assignment	Variable Attribute	Saving
UINT	1 to 50000	100	Watt	RW	No	Always	Yes

When using an external regenerative resistance (0x2009=1), set maximum allowable capacity of regenerative resistance in the unit of watt. When using an internal regenerative resistance (0x2009= 0), the setting value does not apply. Unless specified otherwise, set the value to be 5 times of regenerative resistance capacity [0x200C].

0x200E	Duration Time @ Peak Power of Regeneration Brake Resistor						ALL
Variable Type	Setting Range	Initial Value	Unit	Accessibility	PDO Assignment	Variable Attribute	Saving
UINT	1 to 50000	5000	Ms	RW	No	Always	Yes

When using an external regenerative resistance (0x2009=1), set the allowed time for maximum regenerative resistance capacity (0x200D) in the unit of watt. When using an internal regenerative resistance (0x2009= 0), the setting value does not apply.

0x200F	Overload Check Base						ALL
Variable Type	Setting Range	Initial Value	Unit	Accessi bility	PDO Assignment	Variable Attribute	Savin g
UINT	10 to 120	100	%	RW	No	Always	Yes

This is a parameter for adjusting the load factor for accumulation of continuous accumulated overload.

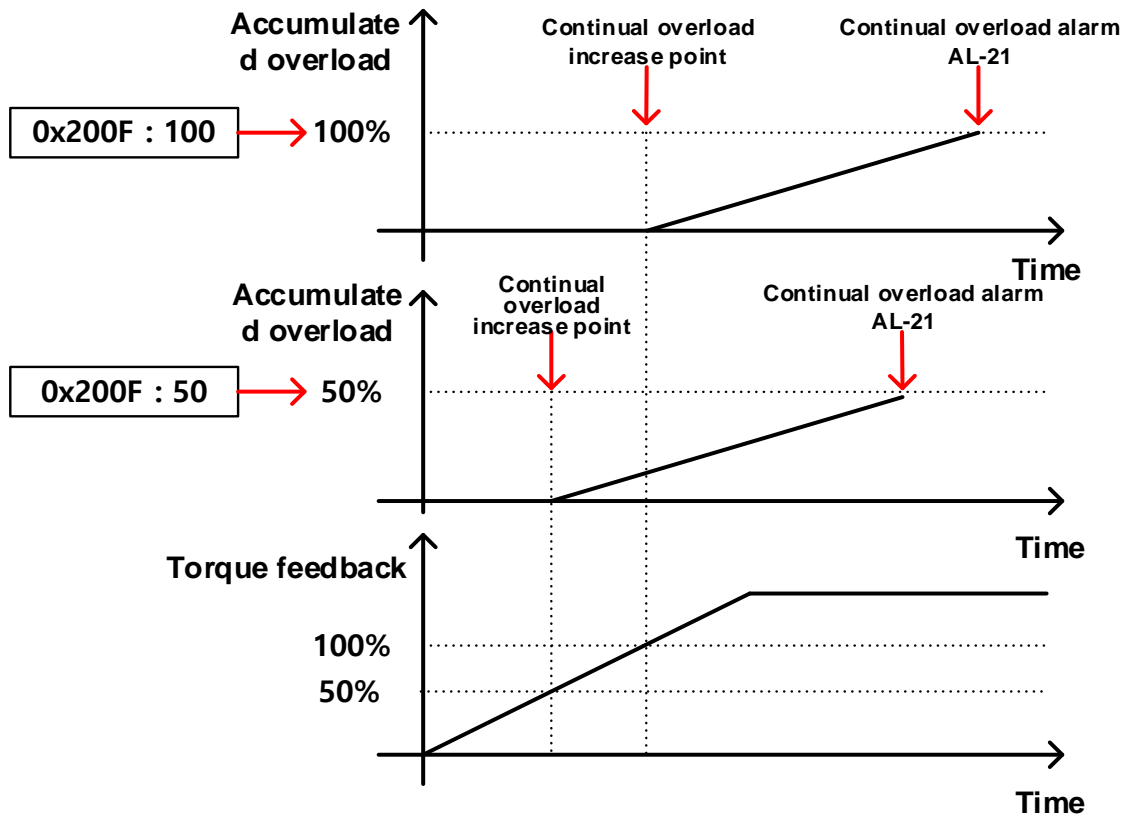

The default value is 100. If torque feedback exceeds 100 [%], accumulated overload keeps accumulating, causing an occurrence of the continuous overload alarm (AL-21). If you set the parameter value to 50 and 100, accumulated overload is activated when torque feedback exceeds 50 [%] and 100 [%], respectively. Therefore, for any given time period, the setting with 50 causes accumulation quicker than one with 100, causing AL-21 to occur earlier.

If the heat radiation condition of the drive is poor, set the value to be 100% or lower to trigger an overload alarm more quickly.

0x2010	Overload Warning Level						ALL
Variable Type	Setting Range	Initial Value	Unit	Accessi- bility	PDO Assignment	Variable Attribute	Savin- g
UINT	10 to 100	50	%	RW	No	Always	Yes

This is a parameter for adjusting the output level of the accumulated operation overload warning (W10). When the accumulated operation overload rate (0x2603) reaches the set value, a warning is output. With this setting, you can find out the time point when you need to take an appropriate action before an accumulated operation overload alarm occurs.

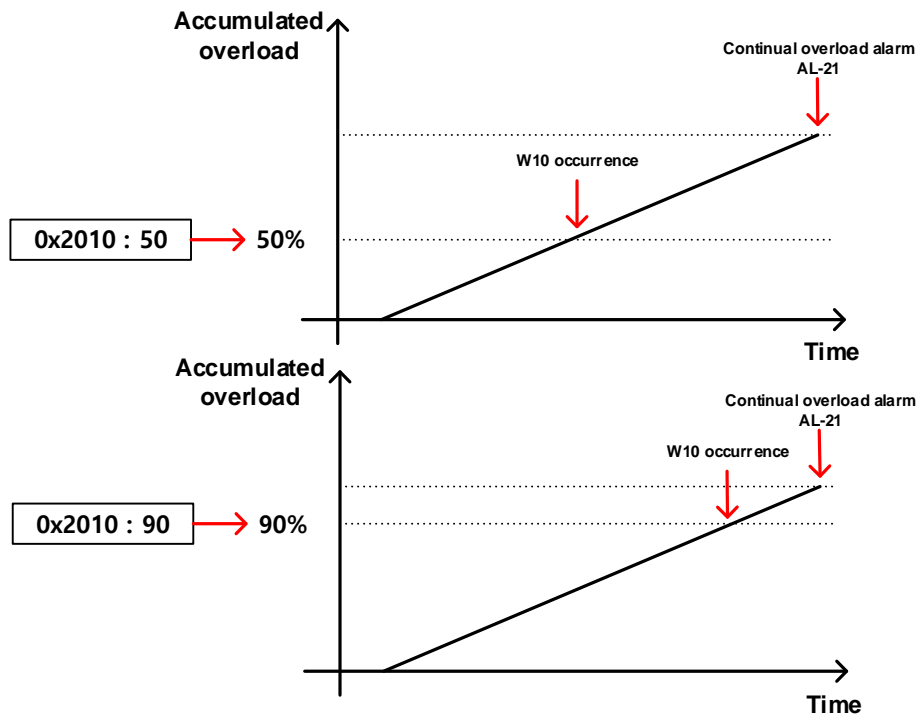

For example, when you input 50, W10 starts to occur at the point when accumulated overload becomes 50 [%]. If you input 90, it starts to occur at the 90 [%] mark. If accumulated overload becomes 100%, W10 is changed into AL-21.

Variable Type	Setting Range	Initial Value	Unit	Accessibility	PDO Assignment	Variable Attribute	Saving
UINT	0 to 1000	10	ms	RW	No	Always	Yes

You can set the delay time until PWM is actually turned off after the servo off command. When using a motor with a brake installed on the vertical axis, you can make the brake signal output to come out first then PWM be turned off after the set time, in order to prevent the axis from flowing down vertically.

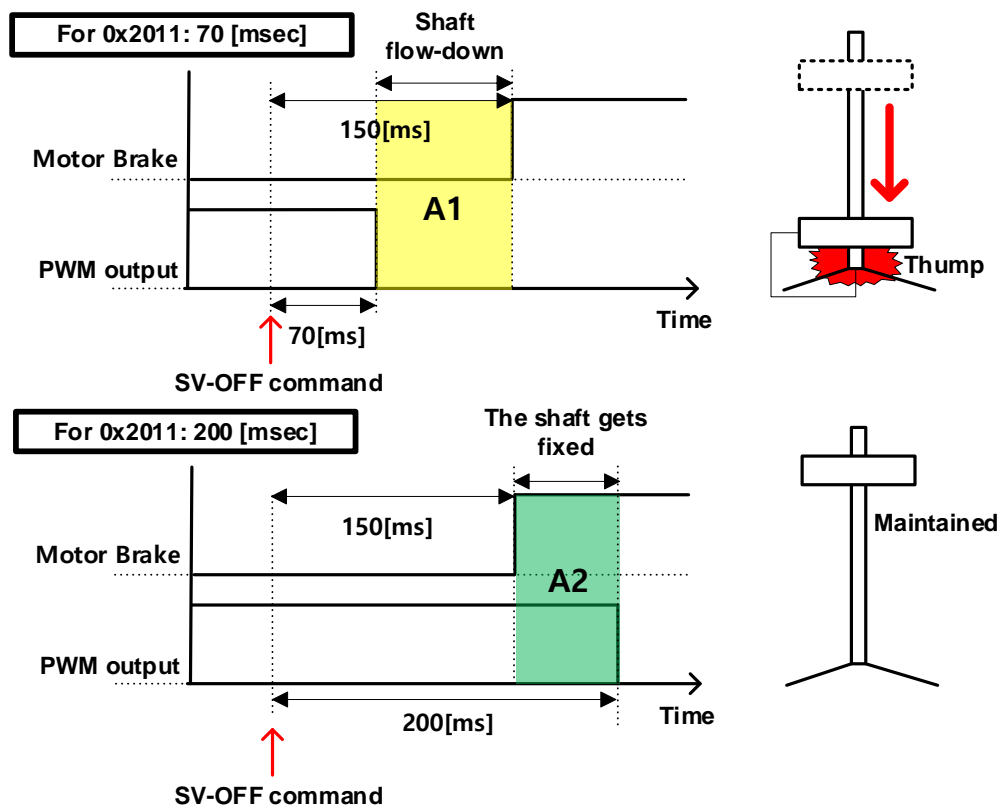

For example, assume that you have set the brake to operate 150 [msec] after a servo off command during operation of a motor with a brake installed on its vertical axis. If you set the parameter to 50 [msec], PWM is turned off in 50 [msec] after a servo off command, causing A1 to occur in which the brake cannot be held. In this case, the axis flows down because of gravity. However, if you set the parameter to 200 [msec], an overlapped section (green) appears in which PWM is output and the brake can be held, which can maintain the vertical axis.

0x2012	Dynamic Brake Control Mode Configuration						ALL
Variable Type	Setting Range	Initial Value	Unit	Accessibility	PDO Assignment	Variable Attribute	Saving
UINT	0 to 3	0	-	RW	No	Always	Yes

You can set the control mode of the dynamic brake in servo off.

Setting Values	Description
0	Hold the dynamic brake after stopping the motor using the brake
1	Release the dynamic brake after stopping the motor using the brake
2	Release the dynamic brake after free-run stop
3	Hold the dynamic brake after free-run stop

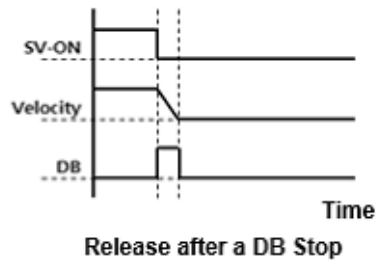
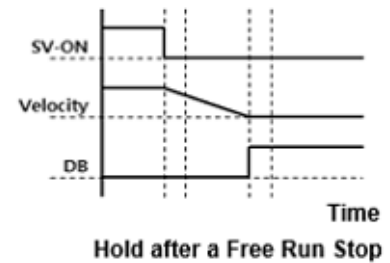
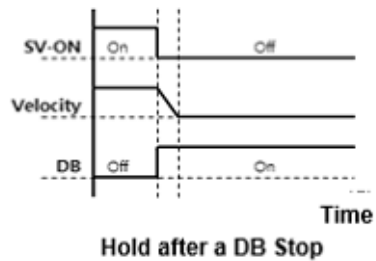

0x2013	Emergency Stop Configuration						ALL
Variable Type	Setting Range	Initial Value	Unit	Accessibility	PDO Assignment	Variable Attribute	Saving
UINT	0 to 1	1	-	RW	No	Always	Yes

You can set the method of emergency stop (for POT, NOT, or ESTOP input). In torque control mode, the deceleration stop mode which uses emergency stop torque is not applied.

Setting Values	Description
0	The motor stops according to the method set in Dynamic Brake Control Mode (0x2012). It stops using the dynamic brake and maintains the torque command at 0.
1	The motor decelerates to a stop using the emergency stop torque (0x2113).

0x2014	Warning Mask Configuration						ALL
Variable Type	Setting Range	Initial Value	Unit	Accessibility	PDO Assignment	Variable Attribute	Saving
UINT	0 to FFFF <sub>hex</sub>	0	-	RW	Yes	Always	Yes

Warnings masked by this setting are not triggered.

Bits	Warning Codes	Warning Names
0	W01	Main power phase loss
1	W02	Low voltage of encoder battery
2	W04	Software position limit
3	W08	DB overcurrent
4	W10	Operation overload
5	W20	Abnormal combination of drive and motor
6	W40	Low voltage
7	W80	Emergency signal input
14	AL-34	Encoder phase Z loss alarm mask

0x2015							
U Phase Current Offset							ALL
Variable Type	Setting Range	Initial Value	Unit	Accessibility	PDO Assignment	Variable Attribute	Saving
INT	-1000 to 1000	0	0.1%	RW	No	Always	Yes
0x2016							
V Phase Current Offset							ALL
Variable Type	Setting Range	Initial Value	Unit	Accessibility	PDO Assignment	Variable Attribute	Saving
INT	-1000 to 1000	0	0.1%	RW	No	Always	Yes
0x2017							
W Phase Current Offset							ALL
Variable Type	Setting Range	Initial Value	Unit	Accessibility	PDO Assignment	Variable Attribute	Saving
INT	-1000 to 1000	0	0.1%	RW	No	Always	Yes

You can manually set the current offset for each phase. The set offset value is subtracted from the measured current value, then applied as an actual current value. Do not manually set the offset if you do not know the exact setting value. You can view the automatically-tuned value if you tune the current offset through the procedure function (Refer to the description of 0x2700).

For a drive with a small to medium capacity (7.5KW or lower), this parameter is not used since the W phase current is not separately measured.

0x2018	Magnetic Pole Pitch						ALL
Variable Type	Setting Range	Initial Value	Unit	Accessi- bility	PDO Assignment	Variable Attribute	Savin- g
UINT	1 to 65535	2400	.01mm	RW	No	Power re-input	Yes

You can set the pitch between the magnetic poles of the linear motor. Pole pitch refers to the distance between the north poles or the south poles of magnets, which corresponds to an electrical angle of 360°.

0x2019	Linear Scale Resolution						ALL
Variable Type	Setting Range	Initial Value	Unit	Accessi- bility	PDO Assignment	Variable Attribute	Savin- g
UINT	1 to 65535	1000	Nm	RW	No	Power re-input	Yes

You can set linear scale resolution in the unit of nm. For a linear scale with a resolution of 1µm, set it to 1000 (= 1µm/1nm).

0x201A	Commutation Method						ALL
Variable Type	Setting Range	Initial Value	Unit	Accessi- bility	PDO Assignment	Variable Attribute	Savin- g
UINT	0 to 2	0	-	RW	No	Power re-input	Yes

You can set the commutation method used to get information on the initial angle of the motor.

Setting Values	Description
0	Separate commutation is unnecessary or it carries out commutation using a hall sensor
1	Carries out commutation when the servo is turned on for the first time
2	Reserved

0x201B	Commutation Current						ALL
Variable Type	Setting Range	Initial Value	Unit	Accessi- bility	PDO Assignment	Variable Attribute	Savin- g
UINT	0 to 1000	500	0.1%	RW	No	Always	Yes

You can set the commutation current used to get information on the initial angle of the motor.



0x201C	Commutation Time						ALL
Variable Type	Setting Range	Initial Value	Unit	Accessi- bility	PDO Assignment	Variable Attribute	Savin- g
UINT	500 to 5000	1000	ms	RW	No	Always	Yes

You can set the commutation time used to get information on the initial angle of the motor.

0x201D	Grating Period of Sinusoidal Encoder						ALL
Variable Type	Setting Range	Initial Value	Unit	Accessi- bility	PDO Assignment	Variable Attribute	Savin- g
UINT	1 to 65535	40	um	RW	No	Power re-input	Yes

You can set the grid size of the sine wave encoder.

0x201E	Homing Done Behavior						ALL
Variable Type	Setting Range	Initial Value	Unit	Accessi- bility	PDO Assignment	Variable Attribute	Savin- g
UINT	0 to 1	0	-	RW	No	Always	Yes

You can set whether or not to move to Zero Position by home offset [0x3019] after homing is complete.

Setting Values	Description
0	After completion of homing by Homing Method[0x3018], the motor does not rotate and the Home Offset[0x3019] value becomes Zero Position.
1	After completion of homing by Homing Method[0x3018], the motor rotates as much as Home Offset[0x3019] and Zero Position becomes 0.

0x201F	Velocity Function Select						ALL
Variable Type	Setting Range	Initial Value	Unit	Accessibility	PDO Assignment	Variable Attribute	Saving
UINT	0 to 2	0	-	RW	No	Always	Yes

You can select the calculation method of feedback speed when the encoder type is Quadrature.

Setting Values	Description
0	MT Method + Speed Observer
1	MT Method
2	M Method

0x2020	Motor Hall Phase Config.						ALL
Variable Type	Setting Range	Initial Value	Unit	Accessibility	PDO Assignment	Variable Attribute	Saving
UINT	0 to 65535	0	-	RW	No	Power re-input	Yes

For a 3rd party motor, you can set the motor's rotation direction, the polarity of the hall sensor signal, and the sequence of the hall sensor's UVW by examining wiring of the motor and the hall sensor.

Bits	Description
0	Sets the motor's rotation direction (computation of the 0x2004 setting value and Exclusive OR possible)
1~7	Reserved
8	Reverses Hall U polarity
9	Reverses Hall V polarity
10	Reverses Hall W polarity
11	Reserved
12	Replaces Hall U, Hall V
13	Replaces Hall V, Hall W
14	Replaces Hall W, Hall U
15	Single-ended use (when a 3 <sup>rd</sup> party motor is applied)

## 14.3 Gain Adjustment (0x2100~)

0x2100	Inertia Ratio						ALL
Variable Type	Setting Range	Initial Value	Unit	Accessibility	PDO Assignment	Variable Attribute	Saving
UINT	0 to 3000	100	%	RW	No	Always	Yes

You can set the ratio of load inertia to the motor's rotor inertia in %.

Inertia ratio= load inertia/motor's rotor inertia x 100

This inertia ratio setting is an important control parameter for operation of the servo. Therefore it is crucial to set the inertia ratio accurately for optimal servo operation. You can estimate the inertia ratio value by automatic gain tuning. The ratio is continuously estimated during operation if you carry out On-line gain tuning.

0x2101	Position Loop Gain 1						ALL
Variable Type	Setting Range	Initial Value	Unit	Accessibility	PDO Assignment	Variable Attribute	Saving
UINT	1 to 500	50	1/s	RW	Yes	Always	Yes

You can set the overall responsiveness of the position controller. The larger the setting value is, the higher the responsiveness is. Too large of a setting value may cause vibration depending on the load.

0x2102	Speed Loop Gain 1						ALL
Variable Type	Setting Range	Initial Value	Unit	Accessibility	PDO Assignment	Variable Attribute	Saving
UINT	1 to 2000	75	Hz	RW	Yes	Always	Yes

You can set the overall responsiveness of the velocity controller. To raise the overall responsiveness of the system, you have to set Speed Loop Gain as well as position loop gain to a large value. Too large of a setting value may cause vibration depending on the load.

0x2103	Speed Loop Integral Time Constant 1						ALL
Variable Type	Setting Range	Initial Value	Unit	Accessibility	PDO Assignment	Variable Attribute	Saving
UINT	1 to 1000	50	ms	RW	Yes	Always	Yes

You can set integral time constant of the velocity controller. If you set it to a large value, error is reduced in the steady state (stopped or driving at a constant velocity), but vibration may occur at a transitional state (while accelerating or decelerating).

0x2104	Torque Command Filter Time Constant 1						ALL
Variable Type	Setting Range	Initial Value	Unit	Accessibility	PDO Assignment	Variable Attribute	Saving
UINT	0 to 1000	5	0.1ms	RW	Yes	Always	Yes

You can apply a low pass filter for torque command. You can improve the system's stability by setting an appropriate value to smoothen the torque command. If you set the value to be too large, the delay for the torque command is extended, reducing the system responsiveness.

0x2105	Position Loop Gain 2						ALL
Variable Type	Setting Range	Initial Value	Unit	Accessibility	PDO Assignment	Variable Attribute	Saving
UINT	1 to 500	30	1/s	RW	Yes	Always	Yes

You can set position loop gain used as Gain Group 2 for gain conversion. For more information, refer to the description of position loop gain 1 (0x2101).

0x2106	Speed Loop Gain 2						ALL
Variable Type	Setting Range	Initial Value	Unit	Accessibility	PDO Assignment	Variable Attribute	Saving
UINT	1 to 2000	50	Hz	RW	Yes	Always	Yes

You can set Speed Loop Gain used as Gain Group 2 for gain conversion. For more information, refer to the description of the Speed Loop Gain 1 (0x2102).

0x2107	Speed Loop Integral Time Constant 2						ALL
Variable Type	Setting Range	Initial Value	Unit	Accessibility	PDO Assignment	Variable Attribute	Saving
UINT	1 to 1000	50	Ms	RW	Yes	Always	Yes

You can set the integral time constant of the speed loop used as Gain Group 2 for gain conversion. For more information, refer to the description of Speed Loop Integral Time Constant 1 (0x2103).

0x2108	Torque Command Filter Time Constant 2						ALL
Variable Type	Setting Range	Initial Value	Unit	Accessibility	PDO Assignment	Variable Attribute	Saving
UINT	0 to 1000	5	0.1ms	RW	Yes	Always	Yes

You can set time constant of the torque command filter time constant used as Gain Group 2 for gain conversion. For more information, refer to the description of torque command filter time constant 1 (0x2104).

0x2109	Position Command Filter Time Constant						ALL
Variable Type	Setting Range	Initial Value	Unit	Accessibility	PDO Assignment	Variable Attribute	Saving
UINT	0 to 10000	0	0.1ms	RW	Yes	Always	Yes

You can apply a low pass filter for position command to smoothen the position command. Especially, this can be used for setting a higher gear ratio. This does not apply when the setting value is 0.

0x210A	Position Command Average Filter Time Constant						ALL
Variable Type	Setting Range	Initial Value	Unit	Accessibility	PDO Assignment	Variable Attribute	Saving
UINT	0 to 10000	0	0.1ms	RW	Yes	Always	Yes

You can apply a movement average filter for position command to smoothen the position command. The setting value of position command filter time constant (0x2109) is first applied as a priority. This function is applicable only when the position command filter time constant value is 0.

0x210B	Speed Feedback Filter Time Constant						ALL
Variable Type	Setting Range	Initial Value	Unit	Accessibility	PDO Assignment	Variable Attribute	Saving
UINT	0 to 10000	5	0.1ms	RW	Yes	Always	Yes

You can apply a low pass filter to the speed feedback signal calculated in the encoder. When system vibration occurs or vibration occurs due to a gain load with an excessive inertia is applied, you can suppress vibration by setting an appropriate value.

0x210C	Velocity Feed-Forward Gain						ALL
Variable Type	Setting Range	Initial Value	Unit	Accessibility	PDO Assignment	Variable Attribute	Saving
UINT	0 to 100	0	%	RW	Yes	Always	Yes

You can set feedforward gain for the velocity command during position control. The larger the setting value is, the lower the positional error is. If you set too large a value for the load, vibration or an overshoot may occur. For gain tuning, increase the setting value gradually.

0x210D	Velocity Feed-forward Filter Time Constant						ALL
Variable Type	Setting Range	Initial Value	Unit	Accessibility	PDO Assignment	Variable Attribute	Saving
UINT	0 to 1000	10	0.1ms	RW	Yes	Always	Yes

You can apply a low pass filter to the compensation amount added to the velocity command by velocity feedforward gain. You can enhance the system's stability by using it when you have set a large velocity feedforward gain or when there is an excessive change in position command.

0x210E	Torque Feed-Forward Gain						ALL
Variable Type	Setting Range	Initial Value	Unit	Accessibility	PDO Assignment	Variable Attribute	Saving
UINT	0 to 100	0	%	RW	Yes	Always	Yes

You can set feedforward gain for the torque command during velocity control.

0x210F	Torque Feed-Forward Filter Time Constant						ALL
Variable Type	Setting Range	Initial Value	Unit	Accessibility	PDO Assignment	Variable Attribute	Saving
UINT	0 to 1000	10	0.1ms	RW	Yes	Always	Yes

You can apply a low pass filter to the compensation amount added to the torque command by torque feedforward gain.

0x2110	Torque Limit Function Select						ALL
Variable Type	Setting Range	Initial Value	Unit	Accessibility	PDO Assignment	Variable Attribute	Saving
UINT	0 to 4	2	-	RW	Yes	Always	Yes

You can set the function used to limit output torque of the drive.

Setting	Description
0	Limits the torque value using positive/negative torque limits according to the driving direction - Forward: 0x3022, reverse: 0x3023
1	The limit is set to 300% regardless of the driving direction
2	Limits the torque value using external positive/negative torque limits according to the driving direction - forward: 0x2111, Reverse: 0x2112
3	Limits the torque value using internal and external torque limits according to the driving direction and the torque limit signal - Forward: 0x3022 (P_CL signal not input), 0x2111 (P_CL signal input) - reverse: 0x3023 (N_CL signal not input), 0x2112 (N_CL signal input)
4	Limits applied by analog input torque limit values. - Refer to analog torque limit scale (0x2210) and offset (0x2211)

0x2111	External Positive Torque Limit Value						ALL
Variable Type	Setting Range	Initial Value	Unit	Accessibility	PDO Assignment	Variable Attribute	Saving
UINT	0 to 5000	3000	0.1%	RW	Yes	Always	Yes

You can set the external forward direction torque limit according to the torque limit function setting (0x2110).

0x2112	External Negative Torque Limit Value						ALL
Variable Type	Setting Range	Initial Value	Unit	Accessibility	PDO Assignment	Variable Attribute	Saving
UINT	0 to 5000	3000	0.1%	RW	Yes	Always	Yes

You can set the external reverse direction torque limit according to the torque limit function setting (0x2110).

0x2113	Emergency Stop Torque						ALL
Variable Type	Setting Range	Initial Value	Unit	Accessibility	PDO Assignment	Variable Attribute	Saving
UINT	0 to 5000	1000	0.1%	RW	Yes	Always	Yes

You can set torque stop during emergency stop (POT, NOT, ESTOP input).

0x2114	P/PI Control Conversion Mode						ALL
Variable Type	Setting Range	Initial Value	Unit	Accessibility	PDO Assignment	Variable Attribute	Saving
UINT	0 to 4	0	-	RW	Yes	Always	Yes

You can set the switch mode between PI control and P control. Using this function, you can improve the velocity control characteristic to reduce overshoot during velocity operation and positioning time during position operation.

Setting Values	Setting Details
0	Always use PI control
1	Switch to P control if the command torque is larger than the P control switch torque (0x2115)
2	Switch to P control if the command speed is larger than P control switch speed (0x2116)
3	Switch to P control if the acceleration command is larger than P control switch acceleration (0x2117)
4	Switch to P control if the position error is larger than P control switch position error (0x2118)



0x2115	P Control Switch Torque						ALL
Variable Type	Setting Range	Initial Value	Unit	Accessibility	PDO Assignment	Variable Attribute	Saving
UINT	0 to 5000	500	0.1%	RW	Yes	Always	Yes

Refer to the description of P/PI Control Switch Mode (0x2114).

0x2116	P Control Switch Speed						ALL
Variable Type	Setting Range	Initial Value	Unit	Accessibility	PDO Assignment	Variable Attribute	Saving
UINT	0 to 6000	100	Rpm	RW	Yes	Always	Yes

Refer to the description of P/PI Control Switch Mode (0x2114).

0x2117	P Control Switch Acceleration						ALL
Variable Type	Setting Range	Initial Value	Unit	Accessibility	PDO Assignment	Variable Attribute	Saving
UINT	0 to 60000	1000	rpm/s	RW	Yes	Always	Yes

Refer to the description of P/PI Control Switch Mode (0x2114).

0x2118	P Control Switch Following Error						ALL
Variable Type	Setting Range	Initial Value	Unit	Accessibility	PDO Assignment	Variable Attribute	Saving
UINT	0 to 60000	100	pulse	RW	Yes	Always	Yes

Refer to the description of P/PI Control Switch Mode (0x2114).

0x2119	Gain Conversion Mode						ALL
Variable Type	Setting Range	Initial Value	Unit	Accessibility	PDO Assignment	Variable Attribute	Saving
UINT	0 to 7	0	-	RW	Yes	Always	Yes

You can enhance the performance of the entire system by switching between two gain groups. According to the switching mode, you can perform manual switch by external input or automatic switch by output signals.

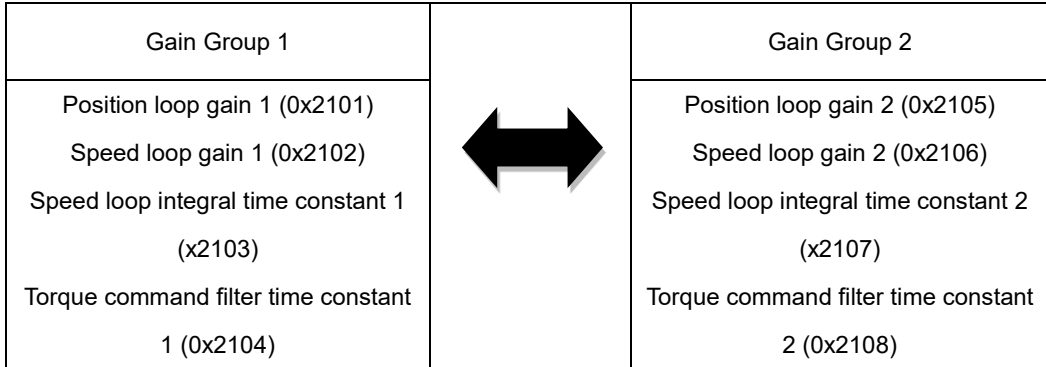

Setting Values	Setting Details
0	Only Gain Group 1 is used
1	Only Gain Group 2 is used
2	Gain is switched according to the GAIN2 input status - 0: Use gain group 1 - 1: Use gain group 2
3	Reserved
4	Reserved
5	Reserved
6	Gain is switched according to the ZSPD output status - 0: Use gain group 1 - 1: Use gain group 2
7	Gain is switched according to the INPOS1 output status - 0: Use gain group 1 - 1: Use gain group 2

0x211A	Gain Conversion Time 1						ALL
Variable Type	Setting Range	Initial Value	Unit	Accessibility	PDO Assignment	Variable Attribute	Saving
UINT	0 to 1000	2	ms	RW	Yes	Always	Yes

You can set the time to switch from Gain Group 1 to Gain Group 2.

0x211B	Gain Conversion Time 2						ALL
Variable Type	Setting Range	Initial Value	Unit	Accessibility	PDO Assignment	Variable Attribute	Saving
UINT	0 to 1000	2	Ms	RW	Yes	Always	Yes

You can set the time to switch from Gain Group 2 to Gain Group 1.

0x211C	Gain Conversion Waiting Time 1						ALL
Variable Type	Setting Range	Initial Value	Unit	Accessibility	PDO Assignment	Variable Attribute	Saving
UINT	0 to 1000	0	Ms	RW	Yes	Always	Yes

You can set the waiting time before switching from Gain Group 1 to Gain Group 2.

0x211D	Gain Conversion Waiting Time 2						ALL
Variable Type	Setting Range	Initial Value	Unit	Accessibility	PDO Assignment	Variable Attribute	Saving
UINT	0 to 1000	0	Ms	RW	Yes	Always	Yes

You can set the waiting time before switching from Gain Group 2 to Gain Group 1.

0x211E	Dead Band for Position Control						ALL
Variable Type	Setting Range	Initial Value	Unit	Accessibility	PDO Assignment	Variable Attribute	Saving
UINT	0 to 1000	0	UU	RW	Yes	Always	Yes

The position controller output becomes 0 if positional error for position control is below the setting.

0x211F	Drive Control Input 1						ALL
Variable Type	Setting Range	Initial Value	Unit	Accessibility	PDO Assignment	Variable Attribute	Saving
UINT	0 to FFFF <sub>hex</sub>	0	-	RW	Yes	Always	No

For the signal for the input contact of the drive, you can set the bit for the input value in this setting other than using the signals input through the CN1 connector. Also, you can perform a logical OR computation of the signals input through the CN1 connector and the bit value of this setting to operate the function.

For the input contacts that can be set, refer to the table below.

Bits	Setting Details	Bits	Setting Details
0	POT	8	MODE
1	NOT	9	Reserved
2	HOME	10	EMG
3	STOP	11	A_RST
4	PCON	12	SV_ON
5	GAIN2	13	SPD1/LVSF1
6	P_CL	14	SPD2/LVSF2
7	N_CL	15	SPD3

0x2120	Drive Control Input 2						ALL
Variable Type	Setting Range	Initial Value	Unit	Accessibility	PDO Assignment	Variable Attribute	Saving
UINT	0 to FFFF <sub>hex</sub>	0	-	RW	Yes	Always	No

This is the same function as [0x211F], and only the settable elements are different. For the input contacts that can be set, refer to the table below.

Bits	Setting Details	Bits	Setting Details
0	START	8	ISEL4
1	PAUSE	9	ISEL5
2	REGT	10	ABSRQ
3	HSTART	11	JSTART
4	ISEL0	12	JDIR
5	ISEL1	13	PCLEAR
6	ISEL2	14	AOVR
7	ISEL3	15	INHIB

0x2121	Drive Status Output 1						ALL
Variable Type	Setting Range	Initial Value	Unit	Accessibility	PDO Assignment	Variable Attribute	Saving
UINT	0 to FFFF <sub>hex</sub>	0	-	RO	Yes	-	No

You can assign the drive output signal status to CN1 output signal in order to view the applicable bit of this output value in addition to performing actual output.

Bits	Setting Details	Bits	Setting Details
0	BRAKE	6	VLMT
1	ALARM	7	INSPD
2	READY	8	WARN
3	ZSPD	9	TGON
4	INPOS1	10	INPOS2
5	TLMT	15-11	Reserved

0x2122	Drive Status Output 2						ALL
Variable Type	Setting Range	Initial Value	Unit	Accessibility	PDO Assignment	Variable Attribute	Saving
UINT	0 to FFFF <sub>hex</sub>	0	-	RO	Yes	-	No

You can assign the drive output signal status to CN1 output signal in order to view the applicable bit of this output value in addition to performing actual output.

Bits	Setting Details	Bits	Setting Details
0	ORG	5	IOUT3
1	EOS	6	IOUT4
2	IOUT0	7	IOUT5
3	IOUT1	15-8	Reserved
4	IOUT2		

## 14.4 I/O Configuration (0x2200~)

0x2200	Digital Input Signal 1 Selection						ALL
Variable Type	Setting Range	Initial Value	Unit	Accessibility	PDO Assignment	Variable Attribute	Saving
UINT	0 to 0xFFFF	0x000F	-	RW	No	Always	Yes

You can set the functions of Digital Input Signal 1 of CN1 connector and the input signal level.

Bits	Setting Details
15	Signal input level settings (0: contact A, 1: contact B)
14~8	Reserved
7~0	Assign input signal.

Setting ex) If the setting value is 0x0006

0	0	0	6
Contact A		GAIN2 assigned	

Setting ex) If the setting value is 0x8002

8	0	0	2
Contact B		NOT assigned	

Setting Values	Assigned Signals	Setting Values	Assigned Signals
0x00	Not assigned	0x14	ISEL0
0x01	POT	0x15	ISEL1
0x02	NOT	0x16	ISEL2
0x03	HOME	0x17	ISEL3
0x04	STOP	0x18	ISEL4
0x05	PCON	0x19	ISEL5
0x06	GAIN2	0x1A	ABSRQ
0x07	P_CL	0x1B	JSTART
0x08	N_CL	0x1C	JDIR
0x09	Reserved	0x1D	PCLR
0x0A	Reserved	0x1E	AOVR
0x0B	EMG	0x1F	INBIT
0x0C	A_RST	0x20	SPD1/LVSF1
0x0F	SV_ON	0x21	SPD2/LVSF2
0x10	START	0x22	SPD3
0x11	PAUSE	0x23	MODE
0x12	REGT	0x24	EGEAR1
0x13	HSTART	0x25	EGEAR2
		0x26	ABS_RESET

0x2201	Digital Input Signal 2 Selection						ALL
Variable Type	Setting Range	Initial Value	Unit	Accessibility	PDO Assignment	Variable Attribute	Saving
UINT	0 to 0xFFFF	0x0020	-	RW	No	Always	Yes

You can set the functions of Digital Input Signal 2 of CN1 connector and the input signal level. For more information, refer to the description of 0x2200.

0x2202	Digital Input Signal 3 Selection						ALL
Variable Type	Setting Range	Initial Value	Unit	Accessibility	PDO Assignment	Variable Attribute	Saving
UINT	0 to 0xFFFF	0x0021	-	RW	No	Always	Yes

You can set the functions of Digital Input Signal 3 of CN1 connector and the input signal level. For more information, refer to the description of 0x2200.

0x2203	Digital Input Signal 4 Selection						ALL
Variable Type	Setting Range	Initial Value	Unit	Accessi bility	PDO Assignment	Variable Attribute	Savin g
UINT	0 to 0xFFFF	0x0022	-	RW	No	Always	Yes

You can set the functions of Digital Input Signal 4 of CN1 connector and the input signal level. For more information, refer to the description of 0x2200.

0x2204	Digital Input Signal 5 Selection						ALL
Variable Type	Setting Range	Initial Value	Unit	Accessi bility	PDO Assignment	Variable Attribute	Savin g
UINT	0 to 0xFFFF	0x000C	-	RW	No	Always	Yes

You can set the functions of Digital Input Signal 5 of CN1 connector and the input signal level. For more information, refer to the description of 0x2200.

0x2205	Digital Input Signal 6 Selection						ALL
Variable Type	Setting Range	Initial Value	Unit	Accessi bility	PDO Assignment	Variable Attribute	Savin g
UINT	0 to 0xFFFF	0x001C	-	RW	No	Always	Yes

You can set the functions of Digital Input Signal 6 of CN1 connector and the input signal level. For more information, refer to the description of 0x2200.

0x2206	Digital Input Signal 7 Selection						ALL
Variable Type	Setting Range	Initial Value	Unit	Accessi bility	PDO Assignment	Variable Attribute	Savin g
UINT	0 to 0xFFFF	0x0001	-	RW	No	Always	Yes

You can set the functions of Digital Input Signal 7 of CN1 connector and the input signal level. For more information, refer to the description of 0x2200.



0x2207	Digital Input Signal 8 Selection						ALL
Variable Type	Setting Range	Initial Value	Unit	Accessibility	PDO Assignment	Variable Attribute	Saving
UINT	0 to 0xFFFF	0x0002	-	RW	No	Always	Yes

You can set the functions of Digital Input Signal 8 of CN1 connector and the input signal level. For more information, refer to the description of 0x2200.

0x2208	Digital Input Signal 9 Selection						ALL
Variable Type	Setting Range	Initial Value	Unit	Accessibility	PDO Assignment	Variable Attribute	Saving
UINT	0 to 0xFFFF	0x000B	-	RW	No	Always	Yes

You can set the functions of Digital Input Signal 9 of CN1 connector and the input signal level. For more information, refer to the description of 0x2200.

0x2209	Digital Input Signal 10 Selection						ALL
Variable Type	Setting Range	Initial Value	Unit	Accessibility	PDO Assignment	Variable Attribute	Saving
UINT	0 to 0xFFFF	0x0004	-	RW	No	Always	Yes

You can set the functions of Digital Input Signal 10 of CN1 connector and the input signal level. For more information, refer to the description of 0x2200.

0x220A	Digital Output Signal 1 Selection						ALL
Variable Type	Setting Range	Initial Value	Unit	Accessibility	PDO Assignment	Variable Attribute	Saving
UINT	0 to 0xFFFF	0x8002	-	RW	No	Always	Yes

You can assign functions to digital output signal 1 and set the output signal level.

15Bit 14Bit 13Bit 12Bit    11Bit 10Bit 9Bit 8Bit

0	0	0	0
0	0	0	0

Signal output level settings

Setting	State
0	Contact A
1	Contact B

7Bit 6Bit 5Bit 4Bit    3Bit 2Bit 1Bit 0Bit

0	0	0	0
0	0	0	0

Output signal assignment

Setting	Assigned signal	Setting	Assigned signal
0x00	Not assigned	0x0A	TGON
0x01	BRAKE	0x0B	INPOS2
0x02	ALARM	0x10	ORG
0x03	READY	0x11	EOS
0x04	ZSPD	0x12	IOUT0
0x05	INPOS1	0x13	IOUT1
0x06	TLMT	0x14	IOUT2
0x07	VLMT	0x15	IOUT3
0x08	INSPD	0x16	IOUT4
0x09	WARN	0x17	IOUT5

The method of function assignment is the same up to Digital Output Signal 5 [0x220E].

ex) When the alarm is set for contact A

15Bit 14Bit 13Bit 12Bit	11Bit 10Bit 9Bit 8Bit	7Bit 6Bit 5Bit 4Bit	3Bit 2Bit 1Bit 0Bit	
0 0 0 0	0 0 0 0	0 0 0 0	0 0 1 0	
0		0		2 → 0x0002

ex) When the alarm is set for contact B

15Bit 14Bit 13Bit 12Bit	11Bit 10Bit 9Bit 8Bit	7Bit 6Bit 5Bit 4Bit	3Bit 2Bit 1Bit 0Bit	
1 0 0 0	0 0 0 0	0 0 0 0	0 0 1 0	
8		0		2 → 0x8002

ex) When IOUOT5 is set for contact B

15Bit 14Bit 13Bit 12Bit	11Bit 10Bit 9Bit 8Bit	7Bit 6Bit 5Bit 4Bit	3Bit 2Bit 1Bit 0Bit	
1 0 0 0	0 0 0 0	0 0 0 1	0 1 1 1	
8		1		7 → 0x8017

0x220B	Digital Output Signal 2 Selection						ALL
Variable Type	Setting Range	Initial Value	Unit	Accessibility	PDO Assignment	Variable Attribute	Saving
UINT	0 to 0xFFFF	0x0003	-	RW	No	Always	Yes

You can assign functions to digital output signal 2 of CN1 connector and set the output signal level. For more information, refer to the description of 0x220A.

0x220C	Digital Output Signal 3 Selection						ALL
Variable Type	Setting Range	Initial Value	Unit	Accessibility	PDO Assignment	Variable Attribute	Saving
UINT	0 to 0xFFFF	0x0004	-	RW	No	Always	Yes

You can assign functions to digital output signal 3 of CN1 connector and set the output signal level. For more information, refer to the description of 0x220A.

0x220D	Digital Output Signal 4 Selection						ALL
Variable Type	Setting Range	Initial Value	Unit	Accessibility	PDO Assignment	Variable Attribute	Saving
UINT	0 to 0xFFFF	0x8001	-	RW	No	Always	Yes

You can assign functions to digital output signal 4 of CN1 connector and set the output signal level. For more information, refer to the description of 0x220A.

0x220E	Digital Output Signal 5 Selection						ALL
Variable Type	Setting Range	Initial Value	Unit	Accessibility	PDO Assignment	Variable Attribute	Saving
UINT	0 to 0xFFFF	0x0005	-	RW	No	Always	Yes

You can assign functions to digital output signal 5 of CN1 connector and set the output signal level. For more information, refer to the description of 0x220A.

0x220F	Analog Velocity Override Mode						ALL
Variable Type	Setting Range	Initial Value	Unit	Accessibility	PDO Assignment	Variable Attribute	Saving
UINT	0 to 2	0	-	RW	No	Always	Yes

You can specify whether or not to use the function that uses analogue voltage to override the velocity.

Setting Values	Setting Details
0	Analog Velocity Override is not used
1	Analog Velocity Override is used 0% for a -10[V] input, 100% for 0[V], and 200% for +10[V] are applied.
2	Analog Velocity Override is used 100% for a 0[V] input and 200% for +10[V] are applied. (-) voltages are recognized as 0[V].

0x2210	Analog Torque Input (command/limit) Scale						ALL
Variable Type	Setting Range	Initial Value	Unit	Accessibility	PDO Assignment	Variable Attribute	Saving
UINT	-1000 to 1000	100	0.1%/V	RW	No	Always	Yes

For non-torque operation, if the setting value of the torque limit function (0x2110) is 4 (analog torque limit), torque is limited by the analog input torque limit. Here, set the scale of the analog input value.

Below is the formula for calculation.

$$\text{Torque limit value}[\%] = \left( \frac{\text{Input voltage}[\text{mv}] - \text{Torque Input Offset}(0\text{x}221\text{C})[\text{mV}]}{1000} \right) \times \frac{\text{Torque Command Scale}[0\text{x}221\text{D}]}{10}$$

Refer to 10.8, "Torque Limit Function."

For torque operation, the parameter is used as the analog torque command scale. The setting value is set to the torque command value at the analog input voltage of ±10[V] in percentage of the rated torque.

0x2211	Analog Torque Input (command/limit) Offset						ALL
Variable Type	Setting Range	Initial Value	Unit	Accessibility	PDO Assignment	Variable Attribute	Saving
INT	-1000 to 1000	0	mV	RW	No	Always	Yes

You can set the analogue voltage offset input by analogue torque limit for non-torque operation.

For torque operation, the parameter is used as the analog torque command offset.

0x2212	Analog Torque Command Clamp Level						T
Variable Type	Setting Range	Initial Value	Unit	Accessibility	PDO Assignment	Variable Attribute	Saving
INT	0 to 1000	0	mV	RW	No	Always	Yes

For analog torque control, there are cases where certain voltage remains in the analog signal connection circuit upon a 0 torque command. Here, 0 torque can be maintained for as much as the command voltage.

0x2213	Analog Torque Command Filter Time Constant						T
Variable Type	Setting Range	Initial Value	Unit	Accessibility	PDO Assignment	Variable Attribute	Saving
UINT	0 to 1000	2	0.1ms	RW	No	Always	Yes

You can improve the stability of command signals by setting the digital filter for analog torque command voltage. If the filter value is set too high, responsiveness to torque commands will be reduced. It is important to set a value that is appropriate for your system.

0x2214	Analog Velocity Command Scale						S
Variable Type	Setting Range	Initial Value	Unit	Accessibility	PDO Assignment	Variable Attribute	Saving
INT	-1000 to 1000	100	rpm/V	RW	No	Always	Yes

When controlling velocity by analog voltage during velocity operation, you can set the analog velocity command value at  $\pm 10[V]$  in the unit of [rpm]. When the setting value is 100, you can control 100[rpm] per command voltage of 1[V].

0x2215	Analog Velocity Input (command/override) Offset						P, S
Variable Type	Setting Range	Initial Value	Unit	Accessibility	PDO Assignment	Variable Attribute	Saving
INT	-1000 to 1000	0	mV	RW	No	Always	Yes

For Indexing Position operation, you can set the analog voltage offset input through analog velocity override. For velocity operation, you can set the analog voltage offset input through analog velocity commands.

0x2216	Analog Velocity Command Clamp Level						S
Variable Type	Setting Range	Initial Value	Unit	Accessibility	PDO Assignment	Variable Attribute	Saving
UINT	0 to 1000	0	rpm	RW	No	Always	Yes

When controlling velocity by analog voltage in velocity operation, there are cases where certain voltage remains in the analog signal connection circuit upon a 0 velocity command.

Here, the 0 velocity can be maintained as much as the set voltage command.

0x2217	Analog Velocity Command Filter Time Constant						S
Variable Type	Setting Range	Initial Value	Unit	Accessibility	PDO Assignment	Variable Attribute	Saving
UINT	0 to 1000	2	0.1ms	RW	No	Always	Yes

You can set the digital filter for analog velocity command voltage to improve the stability of the command signals. Here, if the value is set to be too high, responsiveness to velocity commands is reduced. It is important to set a value that is appropriate for your system.

## 14.5 Velocity Control (0x2300~)

0x2300	Jog Operation Speed						ALL
Variable Type	Setting Range	Initial Value	Unit	Accessibility	PDO Assignment	Variable Attribute	Saving
INT	-6000 to 6000	500	Rpm	RW	No	Always	Yes

You can set the Jog operation speed.

0x2301	Speed Command Acceleration Time						ALL
Variable Type	Setting Range	Initial Value	Unit	Accessibility	PDO Assignment	Variable Attribute	Saving
UINT	0 to 10000	200	Ms	RW	No	Always	Yes

You can set the time required for the motor to reach the rated motor speed from a stop in the unit of ms.

0x2302	Speed Command Deceleration Time						ALL
Variable Type	Setting Range	Initial Value	Unit	Accessibility	PDO Assignment	Variable Attribute	Saving
UINT	0 to 10000	200	Ms	RW	No	Always	Yes

You can set the time required for the motor to decelerate from the rated motor speed to a stop in the unit of ms.

0x2303	Speed Command S-curve Time						ALL
Variable Type	Setting Range	Initial Value	Unit	Accessibility	PDO Assignment	Variable Attribute	Saving
UINT	0 to 1000	0	Ms	RW	No	Always	Yes

You can set the velocity command to operate in an S-curve pattern for smooth acceleration/deceleration. If it is set to 0, the drive operates in a trapezoidal pattern by default.

0x2304	Program Jog Operation Speed 1						ALL
Variable Type	Setting Range	Initial Value	Unit	Accessibility	PDO Assignment	Variable Attribute	Saving
INT	-6000 to 6000	0	Rpm	RW	No	Always	Yes

For program jog operation, you can set operation velocity 1 to 4 and operation time 1 to 4 as follows.

0x2305	Program Jog Operation Speed 2						ALL
Variable Type	Setting Range	Initial Value	Unit	Accessibility	PDO Assignment	Variable Attribute	Saving
INT	-6000 to 6000	500	rpm	RW	No	Always	Yes

Refer to the description of program jog operation speed 1 (0x2304).

0x2306	Program Jog Operation Speed 3						ALL
Variable Type	Setting Range	Initial Value	Unit	Accessibility	PDO Assignment	Variable Attribute	Saving
INT	-6000 to 6000	0	rpm	RW	No	Always	Yes

Refer to the description of program jog operation speed 1 (0x2304).

0x2307	Program Jog Operation Speed 4						ALL
Variable Type	Setting Range	Initial Value	Unit	Accessibility	PDO Assignment	Variable Attribute	Saving
INT	-6000 to 6000	-500	rpm	RW	No	Always	Yes

Refer to the description of program jog operation speed 1 (0x2304).

0x2308	Program Jog Operation Time 1						ALL
Variable Type	Setting Range	Initial Value	Unit	Accessibility	PDO Assignment	Variable Attribute	Saving
UINT	0 to 10000	500	ms	RW	No	Always	Yes

Refer to the description of program jog operation speed 1 (0x2304)



0x2309	Program Jog Operation Time 2						ALL
Variable Type	Setting Range	Initial Value	Unit	Accessibility	PDO Assignment	Variable Attribute	Saving
UINT	0 to 10000	5000	Ms	RW	No	Always	Yes

Refer to the description of program jog operation speed 1 (0x2304).

0x230A	Program Jog Operation Time 3						ALL
Variable Type	Setting Range	Initial Value	Unit	Accessibility	PDO Assignment	Variable Attribute	Saving
UINT	0 to 10000	500	Ms	RW	No	Always	Yes

Refer to the description of program jog operation speed 1 (0x2304).

0x230B	Program Jog Operation Time 4						ALL
Variable Type	Setting Range	Initial Value	Unit	Accessibility	PDO Assignment	Variable Attribute	Saving
UINT	0 to 10000	5000	Ms	RW	No	Always	Yes

Refer to the description of program jog operation speed 1 (0x2304).

0x230C	Index Pulse Search Speed						ALL
Variable Type	Setting Range	Initial Value	Unit	Accessibility	PDO Assignment	Variable Attribute	Saving
INT	-1000 to 1000	20	Rpm	RW	No	Always	Yes

You can set the velocity for index pulse search.

0x230D	Speed Limit Function Select						T
Variable Type	Setting Range	Initial Value	Unit	Accessibility	PDO Assignment	Variable Attribute	Saving
UINT	0 to 3	0	-	RW	No	Always	Yes

You can set the speed limit function for torque control.

Setting Values	Setting Details
0	Limited by the speed limit value (0x230E)
1	Limited by the maximum motor speed

0x230E	Velocity Limit Value at Torque Control Mode						T
Variable Type	Setting Range	Initial Value	Unit	Accessibility	PDO Assignment	Variable Attribute	Saving
UINT	0 to 6000	1000	rpm	RW	Yes	Always	Yes

You can set the speed limit value at torque control. This setting is applied only when the Speed Limit Function Select (0x230D) is set to 0.

0x230F	Over Speed Detection Level						ALL
Variable Type	Setting Range	Initial Value	Unit	Accessibility	PDO Assignment	Variable Attribute	Saving
UINT	0 to 10000	6000	rpm	RW	No	Always	Yes

You can set the level of detecting overspeed alarms (AL-50). If the setting value is larger than the maximum motor speed, the detection level is set by the maximum motor speed.

0x2310	Excessive Speed Error Detection Level						ALL
Variable Type	Setting Range	Initial Value	Unit	Accessibility	PDO Assignment	Variable Attribute	Saving
UINT	0 to 10000	5000	rpm	RW	No	Always	Yes

You can set the level of detecting excessive speed error alarms (AL-53). If the difference between the velocity command and the speed feedback exceeds the setting value, an excessive speed error alarm is generated.

0x2311	Servo-Lock Function Select						S
Variable Type	Setting Range	Initial Value	Unit	Accessibility	PDO Assignment	Variable Attribute	Saving
UINT	0 to 1	0	-	RW	No	Always	Yes

You can set the servo-lock function to fix the motor position with a position value when the velocity command of 0 is for velocity control.

Setting Values	Setting Details
0	Servo-lock function disabled
1	Servo-lock function enabled

0x2312	Multi-Step Operation Velocity 1						S
Variable Type	Setting Range	Initial Value	Unit	Accessibility	PDO Assignment	Variable Attribute	Saving
INT	-6000 to 6000	0	Rpm	RW	No	Always	Yes

You can set the velocity for multi-step operation velocity 1 in Velocity Mode. This is the velocity when SPD1, SPD2 and SPD3 input contacts are off.

0x2313	Multi-Step Operation Velocity 2						S
Variable Type	Setting Range	Initial Value	Unit	Accessibility	PDO Assignment	Variable Attribute	Saving
INT	-6000 to 6000	10	Rpm	RW	No	Always	Yes

You can set the velocity for multi-step operation velocity 2 in Velocity Mode. This is the velocity when SPD1 input contact is on and SPD2 and SPD3 input contacts are off.

0x2314	Multi-Step Operation Velocity 3						S
Variable Type	Setting Range	Initial Value	Unit	Accessibility	PDO Assignment	Variable Attribute	Saving
INT	-6000 to 6000	50	Rpm	RW	No	Always	Yes

You can set the velocity for multi-step operation velocity 3 in Velocity Mode. This is the velocity when SPD2 input contact is on and SPD1 and SPD3 input contacts are off.

0x2315	Multi-Step Operation Velocity 4						S
Variable Type	Setting Range	Initial Value	Unit	Accessibility	PDO Assignment	Variable Attribute	Saving
INT	-6000 to 6000	100	Rpm	RW	No	Always	Yes

You can set the velocity for multi-step operation velocity 4 in Velocity Mode. This is the velocity when SPD1 and SPD2 input contacts are on and SPD3 input contact is off.

0x2316	Multi-Step Operation Velocity 5						S
Variable Type	Setting Range	Initial Value	Unit	Accessibility	PDO Assignment	Variable Attribute	Saving
INT	-6000 to 6000	200	rpm	RW	No	Always	Yes

You can set the velocity for multi-step operation velocity 5 in Velocity Mode. This is the velocity when SPD3 input contact is on and SPD1 and SPD2 input contacts are off.

0x2317	Multi-Step Operation Velocity 6						S
Variable Type	Setting Range	Initial Value	Unit	Accessibility	PDO Assignment	Variable Attribute	Saving
INT	-6000 to 6000	500	rpm	RW	No	Always	Yes

You can set the velocity for multi-step operation velocity 6 in Velocity Mode. This is the velocity when SPD1 and SPD3 input contacts are on and SPD2 input contact is off.

0x2318	Multi-Step Operation Velocity 7						S
Variable Type	Setting Range	Initial Value	Unit	Accessibility	PDO Assignment	Variable Attribute	Saving
INT	-6000 to 6000	1000	rpm	RW	No	Always	Yes

You can set the velocity for multi-step operation velocity 7 in Velocity Mode. This is the velocity when SPD2 and SPD3 input contacts are on and SPD1 input contact is off.

0x2319	Multi-Step Operation Velocity 8						S
Variable Type	Setting Range	Initial Value	Unit	Accessibility	PDO Assignment	Variable Attribute	Saving
INT	-6000 to 6000	1500	rpm	RW	No	Always	Yes

You can set the velocity for multi-step operation velocity 8 in Velocity Mode. This is the velocity when SPD1, SPD2 and SPD3 input contacts are on.

0x231A	Velocity Command Switch Select						S
Variable Type	Setting Range	Initial Value	Unit	Accessibility	PDO Assignment	Variable Attribute	Saving
UINT	0 to 3	0	-	RW	No	Always	Yes

You can select the velocity command method for Velocity Mode.

Setting Values	Setting Details
0	Use analog velocity commands
1	Use SPD1, SPD2 contacts and analog velocity commands
2	Use SPD1, SPD2 and SPD3 contacts and analog velocity commands
3	Use velocity commands for SPD1, SPD2 and SPD3 contacts

Analog velocity commands are used when the setting value is 1 and 2 and all applicable contacts are turned on.

ex) apply an analog velocity command of 10[V] when the setting value is 2 and SPD1, SPD2 contacts are turned on

Motor rotation operates at 100[rpm] and analog input velocity commands are ignored.

Operation velocity follows the setting value for parameter 0x2315.

ex) apply an analog velocity command of 10[V] when the setting value is 2 and SPD1, SPD2 and SPD3 contacts are turned on

Motor rotation operates at 1000[rpm] and digital input/output contact velocity commands are ignored.

Operation velocity is set to the analog velocity command voltage according to the setting value of parameter 0x2229.

## 14.6 Miscellaneous Setting (0x2400~)

0x2400	Software Position Limit Function Select						ALL
Variable Type	Setting Range	Initial Value	Unit	Accessibility	PDO Assignment	Variable Attribute	Saving
UINT	0 to 3	0	-	RW	No	Always	Yes

You can set the software position limit function for position control. When using the position limit function, the upper and the lower limits in (0x607D:02) and (0x607D:01) are used.

Encoder specification	Necessary conditions for function use
Incremental encoder	1. Homing must be performed once after a power input. 2. Functions can be used after homing is completed.
Absolute single-turn encoder (BissB)	
Absolute multi-turn encoder (BissC)	1. External batteries must be connected. 2. Absolute Encoder Configuration [0x2005] must be set to 0. 3. There is no need for another homing after the power input. 4. Functions can immediately be used.

The software position limit function can be used in the incremental and singleturn encoders only when the main power is applied and homing is completed. In multiturn encoders, homing is unnecessary when using a multiturn that has a 0 Absolute Encoder Configuration [0x2005]. Also, be aware that this function does not operate when the upper limit is smaller than the lower limit. .

Setting Values	Setting Details
0	None of the forward and reverse direction software position limits are used
1	Only the forward direction software position limit value is used It is not limited for the reverse direction
2	Only the reverse direction software position limit value is used It is not limited for the forward direction
3	Both the forward and the reverse direction software position limits are used

The position limit function can be limitedly used in Jog Operation Mode. When using index, Jog Operation Mode is used for movement of remaining pulses. The function is usable by using the 5th bit of the below parameters.

I/O Signal Configuration [0x300A]

7Bit	6Bit	5Bit	4Bit	3Bit	2Bit	1Bit	0Bit
0	0	0	0	0	0	0	0



Setting Values	Setting Details
0	The software position limit function is not used in Jog Operation Mode
1	The software position limit function is used (both directions) in Jog Operation Mode.

0x2401	INPOS1 Output Range						P
Variable Type	Setting Range	Initial Value	Unit	Accessi- bility	PDO Assignment	Variable Attribute	Savin- g
UINT	0 to 60000	100	UU	RW	Yes	Always	Yes

With the position command not newly updated, if the positional error is retained within the INPOS1 output range for the INPOS1 output time, the INPOS1 signal is output.

0x2402	INPOS1 Output Time						P
Variable Type	Setting Range	Initial Value	Unit	Accessi- bility	PDO Assignment	Variable Attribute	Savin- g
UINT	0 to 1000	0	ms	RW	Yes	Always	Yes

Refer to the description of 0x2401.

0x2403	INPOS2 Output Range						P
Variable Type	Setting Range	Initial Value	Unit	Accessi- bility	PDO Assignment	Variable Attribute	Savin- g
UINT	0 to 60000	100	UU	RW	Yes	Always	Yes

This parameter outputs the INPOS2 signal when the positional error is lower than the setting value. Unlike INPOS1, the INPOS2 signal is output by calculating only the positional error value.

0x2404	ZSPD Output Range						P
Variable Type	Setting Range	Initial Value	Unit	Accessi- bility	PDO Assignment	Variable Attribute	Savin- g
UINT	0 to 6000	10	Rpm	RW	Yes	Always	Yes

When the current velocity is lower than the setting value, the parameter outputs the ZSPD signal.

0x2405	TGON Output Range						P
Variable Type	Setting Range	Initial Value	Unit	Accessibility	PDO Assignment	Variable Attribute	Saving
UINT	0 to 6000	100	Rpm	RW	Yes	Always	Yes

When the current velocity is higher than the setting value, the parameter outputs the TGON signal.

0x2406	INSPD Output Range						P
Variable Type	Setting Range	Initial Value	Unit	Accessibility	PDO Assignment	Variable Attribute	Saving
UINT	0 to 6000	100	Rpm	RW	Yes	Always	Yes

When the velocity error is lower than the setting value, the parameter outputs the INSPD signal.

0x2407	BRAKE Output Speed						P
Variable Type	Setting Range	Initial Value	Unit	Accessibility	PDO Assignment	Variable Attribute	Saving
UINT	0 to 6000	100	Rpm	RW	No	Always	Yes

If the motor stops due to the servo off state or servo alarm during rotation, you can set the velocity (0x2407) and delay time (0x2408) for brake signal output in order to set the output timing. The brake signal is output if the motor rotation velocity goes below the set value (0x2407) or the output delay time (0x2408) has been reached after the servo off command.

0x2408	BRAKE Output Delay Time						P
Variable Type	Setting Range	Initial Value	Unit	Accessibility	PDO Assignment	Variable Attribute	Saving
UINT	0 to 1000	100	ms	RW	No	Always	Yes

Refer to the description of 0x2407.

0x2409	Torque Limit at Homing Using Stopper						ALL
Variable Type	Setting Range	Initial Value	Unit	Accessibility	PDO Assignment	Variable Attribute	Saving
UINT	0 to 2000	250	0.1%	RW	No	Always	Yes

You can set torque limits for homing using the stopper. If you set the value to be too large, the stopper may cause an impact on the machine by collision. So be careful.



0x240A	Duration Time at Homing Using Stopper						ALL
Variable Type	Setting Range	Initial Value	Unit	Accessibility	PDO Assignment	Variable Attribute	Saving
UINT	0 to 1000	50	ms	RW	No	Always	Yes

You can set the time to detect the stopper during homing. Set an appropriate value for the machine.

0x240B	Modulo Mode						ALL
Variable Type	Setting Range	Initial Value	Unit	Accessibility	PDO Assignment	Variable Attribute	Saving
UINT	0 to 5	0	-	RW	No	Power re-input	Yes

L7C does not use the 0x240B parameter.

### When using L7NH

Setting Values	Setting Details
0	Does not use the modulo function.
1	Uses the modulo function to move forward.
2	Uses the modulo function to move backward.
3	Uses the modulo function to move via the possible shortest distance.
4	Uses the Modulo function to move to the absolute position.
5	Uses the Modulo function to move to the relative position.

As shown in the above table, L7NH sets the Modulo Mode [0x240B] parameter to use the movement method. However, L7C uses the Index Type menu with [0x3000] set to 0 in the Index Mode and the coordinate system setting [0x3001] to 1 in the rotary coordinate system to determine the movement method of Modulo Mode.

### When using L7C

Index	SubIndex	Name	Value	Default	Type	R/W	Unit	Min	Max
0x3000	0x0	Control Mode	0	1	UINT	rw		0	9
0x3001	0x0	Coordinate Select	1	0	UINT	rw		0	1

	Index 0	
Index Type	Rotary Absolute	Rotary Positive
Distance [UU]	30	Rotary Negative
Velocity [UU/s]	10	Rotary Shortest
Acceleration [UU/s <sup>2</sup> ]	1000	Rotary Relative
Deceleration [UU/s <sup>2</sup> ]	1000	
Registration Distance [UU]	0	
Registration Velocity [UU/s]	1000000	
Repeat Count	1	
Dwell Time [ms]	200	
Next Index	1	
Action	Wait for Start	
	Copy	Paste

0x240C	Modulo Factor						ALL
Variable Type	Setting Range	Initial Value	Unit	Accessi- bility	PDO Assignment	Variable Attribute	Savin- g
DINT	1 to 0x40000000	3600	UU	RW	No	Power re-input	Yes

You can set the factor for using the Modulo function. You can set the position value that corresponds to one revolution when a user drives the motor.

\* Modulo factor concept

The default formula is as follows.

$$\text{Position Actual Value using Modulo factor} = \text{Position Actual Value} - (\text{Position Actual Value} \div \text{Modulo Factor})$$

× Encoder Pulse per Revolution

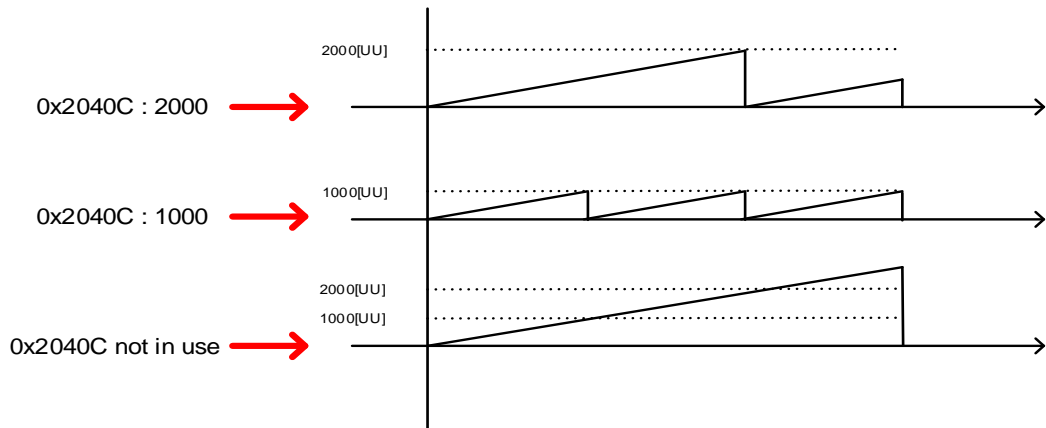

In general, when you do not use the Modulo factor, the current position keeps increasing when the motor rotates in one direction.

If you use Modular factor and input 1000, the current position (Position Actual Value) increases only up to 1000 [UU] is reset to 0 [UU]. Similarly, when you input 2000, it increases only up to 2000 [UU] and is reset. In other words, the remainder value from dividing Position Actual Value by Modulo factor is applied.

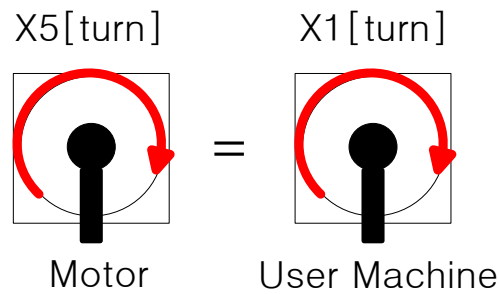

When the machine's apparatus makes 1 [turn], the total pulse required for the machine's 1 [turn] for the installed L7 19 [bit] motor's 5 [turn] is as follows.

$$524288 \times 5[\text{turn}] = 9961472[\text{UU}]$$

If you want to control the machine's 1 [turn] within the range of 0~9961472 [UU],

you can input 9961472 [UU] to make the machine have 1~9961472 [UU] for Position Actual Value within 1 [turn] and restart from 1 [UU] when it exceeds 1 [turn].

\* Modulo factor application example

For L7C, it is applicable if you set the address 0x3000 to operation mode 0 and the address 0x3001 to the rotary coordinate system 1.

To rotate the axis of the machine to the 30 degree mark in Index Operation Mode,

$$9961472[\text{UU}] \times \frac{30^\circ}{360^\circ} = 218453[\text{UU}]$$

you can input 218453 [UU] for index distance.

If you input 1529173 [UU], moving to the 210 degree mark is possible.

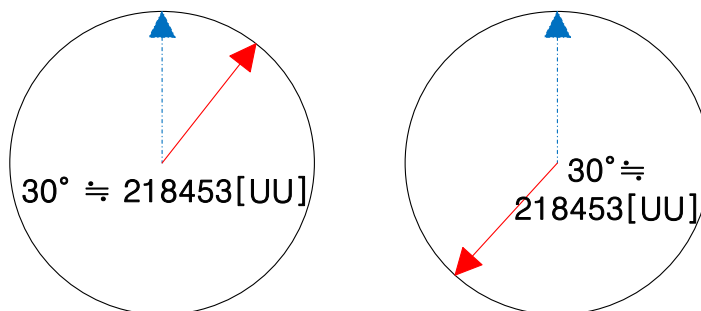

\* Modulo factor advantages

Suppose that a 19-bit motor performs a 60-degree rotation 10,000 times in one direction. If the motor runs in the relative Indexing Position Mode, the error values after the decimal point continue to accumulate to cause a deviation of about 3 degrees after 10,000 rotations.

$$\frac{60}{360} \times 524288 = \frac{2^2 \times 3 \times 5}{2^3 \times 3^2 \times 5} \times 2^{19} = \frac{2^{18}}{3} = 87381.\overline{3333} \text{ [Pulse]}$$

Start count	Pulse count	Resolution	360°	Actual value	Theoretical value
1	87381	524288	360	59.99977112	60
2	174762	524288	360	119.9995422	120
3	262143	524288	360	179.9993134	180
4	349524	524288	360	239.9990845	240
5	436905	524288	360	299.9988556	300
6	524286	524288	360	359.9986267	360
7	611667	524288	360	419.9983978	420
8	699048	524288	360	479.9981689	480
9	786429	524288	360	539.9979401	540
10	873810	524288	360	599.9977112	600

9990	872936190	524288	360	599397.7135	599400
9991	873023571	524288	360	599457.7132	599460
9992	873110952	524288	360	599517.713	599520
9993	873198333	524288	360	599577.7128	599580
9994	873285714	524288	360	599637.7126	599640
9995	873373095	524288	360	599697.7123	599700
9996	873460476	524288	360	599757.7121	599760
9997	873547857	524288	360	599817.7119	599820
9998	873635238	524288	360	599877.7116	599880
9999	873722619	524288	360	599937.7114	599940
10000	873810000	524288	360	599997.7112	600000

In contrast, if the motor runs in the absolute Indexing Position Mode, the error values after the decimal point do not accumulate, and therefore, do not cause any deviation after 10,000 rotations.

$$\frac{60}{360} \times 524288 = \frac{2^2 \times 3 \times 5}{2^3 \times 3^2 \times 5} \times 2^{19} = \frac{2^{18}}{3} = 87381.\overline{3333} \text{ [Pulse]}$$

Start count	Pulse count	Resolution	360°	Actual value	Theoretical value
1	87381	524288	360	59.99977112	60
2	174762	524288	360	119.9995422	120
3	262143	524288	360	179.9993134	180
4	349524	524288	360	239.9990845	240
5	436905	524288	360	299.9998856	300
6	524286	524288	360	359.9986267	360
7	87381	524288	360	59.99977112	420
8	174762	524288	360	119.9995422	480
9	262143	524288	360	179.9993134	540
10	349524	524288	360	239.9990845	600

9990	524286	524288	360	359.9986267	599400
9991	87381	524288	360	59.99977112	599460
9992	174762	524288	360	119.9995422	599520
9993	262143	524288	360	179.9993134	599580
9994	349524	524288	360	239.9990845	599640
9995	436905	524288	360	299.9998856	599700
9996	524286	524288	360	359.9986267	599760
9997	87381	524288	360	59.99977112	599820
9998	174762	524288	360	119.9995422	599880
9999	262143	524288	360	179.9993134	599940
10000	349524	524288	360	239.9990845	600000

0x240D	User Drive Name						ALL
Variable Type	Setting Range	Initial Value	Unit	Accessibility	PDO Assignment	Variable Attribute	Saving
STRING	-	'Drive'	-	RW	No	Always	Yes

You can customize the drive name. You can use up to 16 characters to set the name.

0x240E	Individual Parameter Save						ALL
Variable Type	Setting Range	Initial Value	Unit	Accessibility	PDO Assignment	Variable Attribute	Saving
UINT	0 to 1	0	-	RW	No	Always	No

You can set whether or not to immediately save individual parameters. This parameter is not saved and reset to initial value 0 during power turn-on.

Setting Values	Setting Details
0	Does not save parameters individually. For details on saving parameters, refer to Saving Parameters (0x1010)
1	Saves parameters individually. When a parameter is written, it is immediately saved in the memory

0x240F	RMS Overload Calculation Time						ALL
Variable Type	Setting Range	Initial Value	Unit	Accessibility	PDO Assignment	Variable Attribute	Saving
UINT	100 to 60000	15000	ms	RW	No	Power re-input	Yes

You can set the time to calculate RMS operation overload (0x2619).

0x2410	RTC Time Set						ALL
Variable Type	Setting Range	Initial Value	Unit	Accessibility	PDO Assignment	Variable Attribute	Saving
UDINT	0 to 0xFFFFFFFF	0	-	RW	No	Always	Yes

You can set the time for RTC.

Variable Type	Setting Range	Initial Value	Unit	Accessibility	PDO Assignment	Variable Attribute	Saving
UDINT	0 to 0xFFFFFFFF	1507585	-	RW	No	Always	Yes

You can set the date for RTC.

## 14.7 Enhanced Control (0x2500~)

0x2500	Adaptive Filter Function Select						ALL
Variable Type	Setting Range	Initial Value	Unit	Accessibility	PDO Assignment	Variable Attribute	Saving
UINT	0 to 5	0	-	RW	No	Always	Yes

You can set the adaptive filter function.

Setting Values	Setting Details
0	The adaptive filter is not used
1	Only one adaptive filter is used. You can check the automatic settings in the notch filter 4 settings (0x250A, 0x250B).
2	Only two adaptive filters are used. You can check the automatic settings in the notch filter 3 (0x2507, 0x2508) and 4 settings (0x250A, 0x250B).
3	Reserved
4	Resets the settings of notch filter 3 (0x2507, 0x2508) and notch filter 4 (0x250A, 0x250B, 0x250C)
5	Reserved

0x2501	Notch Filter 1 Frequency						ALL
Variable Type	Setting Range	Initial Value	Unit	Accessibility	PDO Assignment	Variable Attribute	Saving
UINT	50 to 5000	5000	Hz	RW	No	Always	Yes

You can set the frequency of Notch Filter 1.

0x2502	Notch Filter 1 Width						ALL
Variable Type	Setting Range	Initial Value	Unit	Accessibility	PDO Assignment	Variable Attribute	Saving
UINT	1 to 100	1	-	RW	No	Always	Yes

You can set the width of Notch Filter 1.

0x2503	Notch Filter 1 Depth						ALL
Variable Type	Setting Range	Initial Value	Unit	Accessibility	PDO Assignment	Variable Attribute	Saving
UINT	1 to 5	1	-	RW	No	Always	Yes

You can set the depth of Notch Filter 1.

0x2504	Notch Filter 2 Frequency						ALL
Variable Type	Setting Range	Initial Value	Unit	Accessibility	PDO Assignment	Variable Attribute	Saving
UINT	50 to 5000	5000	Hz	RW	No	Always	Yes

You can set the frequency of Notch Filter 2.

0x2505	Notch Filter 2 Width						ALL
Variable Type	Setting Range	Initial Value	Unit	Accessibility	PDO Assignment	Variable Attribute	Saving
UINT	1 to 100	1	-	RW	No	Always	Yes

You can set the width of Notch Filter 2.

0x2506	Notch Filter 2 Depth						ALL
Variable Type	Setting Range	Initial Value	Unit	Accessibility	PDO Assignment	Variable Attribute	Saving
UINT	1 to 5	1	-	RW	No	Always	Yes

You can set the depth of Notch Filter 2.

0x2507	Notch Filter 3 Frequency						ALL
Variable Type	Setting Range	Initial Value	Unit	Accessibility	PDO Assignment	Variable Attribute	Saving
UINT	50 to 5000	5000	Hz	RW	No	Always	Yes

You can set the frequency of Notch Filter 3.

0x2508	Notch Filter 3 Width						ALL
Variable Type	Setting Range	Initial Value	Unit	Accessibility	PDO Assignment	Variable Attribute	Saving
UINT	1 to 100	1	-	RW	No	Always	Yes

You can set the width of Notch Filter 3.

0x2509	Notch Filter 3 Depth						ALL
Variable Type	Setting Range	Initial Value	Unit	Accessibility	PDO Assignment	Variable Attribute	Saving
UINT	1 to 5	1	-	RW	No	Always	Yes

You can set the depth of Notch Filter 3.



0x250A	Notch Filter 4 Frequency						ALL
Variable Type	Setting Range	Initial Value	Unit	Accessibility	PDO Assignment	Variable Attribute	Saving
UINT	50 to 5000	5000	Hz	RW	No	Always	Yes

You can set the frequency of Notch Filter 4.

0x250B	Notch Filter 4 Width						ALL
Variable Type	Setting Range	Initial Value	Unit	Accessibility	PDO Assignment	Variable Attribute	Saving
UINT	1 to 100	1	-	RW	No	Always	Yes

You can set the width of Notch Filter 4.

0x250C	Notch Filter 4 Depth						ALL
Variable Type	Setting Range	Initial Value	Unit	Accessibility	PDO Assignment	Variable Attribute	Saving
UINT	1 to 5	1	-	RW	No	Always	Yes

You can set the depth of Notch Filter 4.

0x250D	On-line Gain Tuning Mode						ALL
Variable Type	Setting Range	Initial Value	Unit	Accessibility	PDO Assignment	Variable Attribute	Saving
UINT	0 to 1	0	-	RW	No	Always	Yes

You can set the On-line gain Tuning Mode.

Setting Values	Setting Details
0	On-line gain tuning not used
1	On-line gain tuning used

0x250E	System Rigidity for Gain Tuning						ALL
Variable Type	Setting Range	Initial Value	Unit	Accessibility	PDO Assignment	Variable Attribute	Saving
UINT	1 to 20	5	-	RW	No	Always	Yes

This specifies the system rigidity applied for gain tuning. After the gain tuning according to the setting, the overall gain will be set higher or lower. If the gain of the maximum setting value is not enough, carry out the tuning manually. After the gain tuning, the following gains will be automatically changed:

Inertia ratio (0x2100), position loop gain 1 (0x2101), speed loop gain 1 (0x2102), speed integral time constant 1 (0x2103), torque command filter time constant 1 (0x2104), notch filter 3 frequency (0x2507, TBD), and notch filter 4 frequency (0x250A, TBD).

0x250F	On-line Gain Tuning Adaptation Speed						ALL
Variable Type	Setting Range	Initial Value	Unit	Accessibility	PDO Assignment	Variable Attribute	Saving
UINT	1 to 5	1	-	RW	No	Always	Yes

You can the speed of reflecting the change in gain when performing On-line gain tuning. The larger the setting value is, the faster the gain changes are reflected.

0x2510	Off-line Gain Tuning Direction						ALL
Variable Type	Setting Range	Initial Value	Unit	Accessibility	PDO Assignment	Variable Attribute	Saving
UINT	0 to 1	0	-	RW	No	Always	Yes

You can set the movement direction when performing offline gain tuning. Set the function properly according to the conditions of the apparatus.

Setting Values	Setting Details
0	Drives in the forward direction
1	Drives in the reverse direction

0x2511	Off-line Gain Tuning Distance						ALL
Variable Type	Setting Range	Initial Value	Unit	Accessibility	PDO Assignment	Variable Attribute	Saving
UINT	1 to 10	5	-	RW	No	Always	Yes

You can set the distance when performing off-line gain tuning. The larger the setting value is, the longer the movement distance becomes. Set the distance properly according to the condition of the apparatus. Make sure to secure an enough distance (more than one revolution of the motor) prior to gain tuning.

0x2512	Disturbance Observer Gain						ALL
Variable Type	Setting Range	Initial Value	Unit	Accessibility	PDO Assignment	Variable Attribute	Saving
UINT	0 to 100	0	%	RW	No	Always	Yes

(to be supported in the future)

0x2513	Disturbance Observer Filter Time Constant						ALL
Variable Type	Setting Range	Initial Value	Unit	Accessibility	PDO Assignment	Variable Attribute	Saving
UINT	0 to 1000	10	0.1ms	RW	No	Always	Yes

(to be supported in the future)

0x2514	Current Controller Gain						ALL
Variable Type	Setting Range	Initial Value	Unit	Accessibility	PDO Assignment	Variable Attribute	Saving
UINT	1 to 150	100	%	RW	No	Always	Yes

You can set gain of the current controller. Lowering the setting value can reduce the noise, but the drive's responsiveness decreases at the same time.

0x2515	Vibration Suppression Filter Configuration						ALL
Variable Type	Setting Range	Initial Value	Unit	Accessibility	PDO Assignment	Variable Attribute	Saving
UINT	0 to 5	0	-	RW	No	Always	Yes

Reserved

0x2516	Vibration Suppression Filter 1 Frequency						ALL
Variable Type	Setting Range	Initial Value	Unit	Accessibility	PDO Assignment	Variable Attribute	Saving
UINT	0 to 2000	0	0.1Hz	RW	No	Always	Yes

Reserved

0x2517	Vibration Suppression Filter 1 Damping						ALL
Variable Type	Setting Range	Initial Value	Unit	Accessibility	PDO Assignment	Variable Attribute	Saving
UINT	0 to 5	0	-	RW	No	Always	Yes

Reserved

0x2518	Vibration Suppression Filter 2 Frequency						ALL
Variable Type	Setting Range	Initial Value	Unit	Accessibility	PDO Assignment	Variable Attribute	Saving
UINT	0 to 2000	0	0.1Hz	RW	No	Always	Yes

Reserved

0x2519	Vibration Suppression Filter 2 Damping						ALL
Variable Type	Setting Range	Initial Value	Unit	Accessibility	PDO Assignment	Variable Attribute	Saving
UINT	0 to 5	0	-	RW	No	Always	Yes

Reserved

## 14.8 Monitoring (0x2600~)

0x2600	Feedback Velocity						ALL
Variable Type	Setting Range	Initial Value	Unit	Accessibility	PDO Assignment	Variable Attribute	Saving
INT	-	-	rpm	RO	Yes	-	No

This parameter represents the current rotation velocity of the motor.

0x2601	Command Speed						ALL
Variable Type	Setting Range	Initial Value	Unit	Accessibility	PDO Assignment	Variable Attribute	Saving
INT	-	-	rpm	RO	Yes	-	No

This parameter represents the velocity command input to the velocity control loop of the drive.

0x2602	Following Error						ALL
Variable Type	Setting Range	Initial Value	Unit	Accessibility	PDO Assignment	Variable Attribute	Saving
DINT	-	-	pulse	RO	Yes	-	No

This parameter represents the positional error of position control.

0x2603	Accumulated Operation Overload						ALL
Variable Type	Setting Range	Initial Value	Unit	Accessibility	PDO Assignment	Variable Attribute	Saving
INT	-	-	0.1%	RO	No	-	No

This parameter represents the accumulated operation overload rate. When the accumulated operation overload rate reaches the overload warning level setting value (0x2010), an operation overload warning (W10) occurs; when it reaches 100%, an operation overload alarm (AL-21) occurs.

0x2604	Instantaneous Maximum Operation Overload						ALL
Variable Type	Setting Range	Initial Value	Unit	Accessi bility	PDO Assignment	Variable Attribute	Savin g
INT	-	-	0.1%	RO	Yes	-	No

This parameter represents the maximum value of operation overload rate output instantaneously from the drive. This value can be initialized by instantaneous maximum operation overload reset.

0x2605	DC-Link Voltage						ALL
Variable Type	Setting Range	Initial Value	Unit	Accessi bility	PDO Assignment	Variable Attribute	Savin g
UINT	-	-	Volt	RO	Yes	-	No

This parameter represents DC link voltage by a main power input.

0x2606	Accumulated Regeneration Overload						ALL
Variable Type	Setting Range	Initial Value	Unit	Accessi bility	PDO Assignment	Variable Attribute	Savin g
INT	-	-	0.1%	RO	No	-	No

This parameter represents the accumulated overload rate of the regenerative resistance from regenerative operation. When the accumulated regenerative overload rate reaches 100%, a regenerative overload alarm (AL-23) is generated.

0x2607	Single-turn Data						ALL
Variable Type	Setting Range	Initial Value	Unit	Accessi bility	PDO Assignment	Variable Attribute	Savin g
UDINT	-	-	pulse	RO	Yes	-	No

This parameter represents the data for one revolution of the motor. A value ranging from 0 to (encoder resolution-1) is displayed.

0x2608	Mechanical Angle						ALL
Variable Type	Setting Range	Initial Value	Unit	Accessi bility	PDO Assignment	Variable Attribute	Savin g
UINT	-	-	0.1deg	RO	Yes	-	No

This parameter represents the single-turn data of the motor in the range of 0.0~359.9.

0x2609	Electrical Angle						ALL
Variable Type	Setting Range	Initial Value	Unit	Accessibility	PDO Assignment	Variable Attribute	Saving
INT	-	-	0.1deg	RO	Yes	-	No

This parameter represents the electrical angle of the motor in the range of -180.0~180.0.

0x260A	Multi-turn Data						ALL
Variable Type	Setting Range	Initial Value	Unit	Accessibility	PDO Assignment	Variable Attribute	Saving
DINT	-	-	rev.	RO	Yes	-	No

This parameter represents multi-turn data of the multi-turn encoder.

0x260B	Drive Temperature 1						ALL
Variable Type	Setting Range	Initial Value	Unit	Accessibility	PDO Assignment	Variable Attribute	Saving
INT	-	-	°C	RO	No	-	No

This is the temperature measured by the temperature sensor integrated into the drive power board. If the measurement is higher 95°C or higher, a drive overheat alarm 1 (AL-22) is generated.

0x260C	Drive Temperature 2						ALL
Variable Type	Setting Range	Initial Value	Unit	Accessibility	PDO Assignment	Variable Attribute	Saving
INT	-	-	°C	RO	No	-	No

This parameter represents the temperature measured by the temperature sensor integrated into the drive control board. If the measured temperature is 90°C or higher, a drive overheat alarm 2 (AL-25) is generated.

0x260D	Encoder Temperature						ALL
--------	---------------------	--	--	--	--	--	-----

Variable Type	Setting Range	Initial Value	Unit	Accessibility	PDO Assignment	Variable Attribute	Saving
INT	-	-	°C	RO	No	-	No

This parameter represents the temperature measured by the temperature sensor integrated into the serial encoder provided by our company (if the setting value of the encoder type (0x2001) is 4). If the measured temperature 90°C or higher, an encoder overheat alarm (AL-26) is generated.

0x260E Motor Rated Speed							
Variable Type	Setting Range	Initial Value	Unit	Accessibility	PDO Assignment	Variable Attribute	Saving
UINT	-	-	rpm	RO	No	-	No

This parameter represents the rated speed of a driving motor.

0x260F Motor Maximum Speed							
Variable Type	Setting Range	Initial Value	Unit	Accessibility	PDO Assignment	Variable Attribute	Saving
UINT	-	-	rpm	RO	No	-	No

This parameter represents the maximum velocity of a driving motor.

0x2610 Drive Rated Current							
Variable Type	Setting Range	Initial Value	Unit	Accessibility	PDO Assignment	Variable Attribute	Saving
UINT	-	-	0.1A	RO	No	-	No

This parameter represents the rated current of the drive.

0x2611 FPGA Version							
Variable Type	Setting Range	Initial Value	Unit	Accessibility	PDO Assignment	Variable Attribute	Saving
STRING	-	-	-	RO	No	-	No

This parameter represents the version of FPGA within the drive.

0x2612 Hall Signal Display							
Variable Type	Setting Range	Initial Value	Unit	Accessibility	PDO Assignment	Variable Attribute	Saving



Type				bility	Assignment	Attribute	g
UINT	-	-	-	RO	No	-	No

This parameter represents the signal of the hall sensor installed in the encoder (or motor). You can use this to verify the connection status of the hall sensor signal or compare the U/V/W-phases of the motor with the direction of the hall sensor signal.

The signal value is repeated in the order of 5→4→6→2→3→1 for a forward movement, and it is repeated in the order of 1→3→2→6→4→5 for a reverse movement.

Bits	Setting Details
0	W-phase hall sensor signal
1	V-phase hall sensor signal
2	U-phase hall sensor signal

0x2613	Bootloader Version						ALL
Variable Type	Setting Range	Initial Value	Unit	Accessi bility	PDO Assignment	Variable Attribute	Savin g
STRING	-	-	-	RO	No	-	No

This parameter represents the bootloader version of the drive.

0x2614	Warning Code						ALL
Variable Type	Setting Range	Initial Value	Unit	Accessi bility	PDO Assignment	Variable Attribute	Savin g
UINT	-	-	-	RO	Yes	-	No

This parameter represents a warning code which occurred in the drive.

0x2615	Analog Input Channel 1 Value						ALL
Variable Type	Setting Range	Initial Value	Unit	Accessi bility	PDO Assignment	Variable Attribute	Savin g
INT	-	-	mV	RO	Yes	-	No

This parameter represents the input voltage of an analog torque command in mV.

0x2616	Analog Input Channel 2 Value						ALL
Variable	Setting Range	Initial Value	Unit	Accessi	PDO	Variable	Savin
				bility	Assignment	Attribute	g

Type				bility	Assignment	Attribute	g
INT	-	-	mV	RO	Yes	-	No

This parameter represents the input voltage of an analog velocity override in mV.

0x2619	RMS Operation Overload						ALL
Variable Type	Setting Range	Initial Value	Unit	Accessi bility	PDO Assignment	Variable Attribute	Savin g
INT	-	-	0.1%	RO	No	-	No

This parameter represents the RMS load factor for 15 seconds in the unit of 0.1%.

0x261D	Software Version						ALL
Variable Type	Setting Range	Initial Value	Unit	Accessi bility	PDO Assignment	Variable Attribute	Savin g
STRING	-	-	-	RO	No	-	No

This parameter displays the software version of the servo drive.

0x261E	Pulse Input Frequency						P
Variable Type	Setting Range	Initial Value	Unit	Accessi bility	PDO Assignment	Variable Attribute	Savin g
INT	-	-	Kpps	RO	No	-	No

This parameter displays the frequency of a pulse input during Pulse Input Position.

0x261F	Torque Limit Value						ALL
Variable Type	Setting Range	Initial Value	Unit	Accessi bility	PDO Assignment	Variable Attribute	Savin g
DINT	-	-	0.1%	RO	No	-	-

This parameter displays the setting value for torque limit.

0x2620	Digital Input Status						ALL
--------	----------------------	--	--	--	--	--	-----

Variable Type	Setting Range	Initial Value	Unit	Accessibility	PDO Assignment	Variable Attribute	Saving
UINT	-	-	-	RO	No	-	No

This parameter displays the input contact status that the servo drive recognizes.

0x2621	Digital Output Status							ALL
Variable Type	Setting Range	Initial Value	Unit	Accessibility	PDO Assignment	Variable Attribute	Saving	
UINT	-	-	-	RO	No	-	No	

This parameter displays the output contact status that the servo drive recognizes.

0x2622	Current RTC Time							ALL
Variable Type	Setting Range	Initial Value	Unit	Accessibility	PDO Assignment	Variable Attribute	Saving	
UDINT	-	-	-	RO	No	Always	Yes	

This parameter displays the current time of RTC.

0x2623	Current RTC Date							ALL
Variable Type	Setting Range	Initial Value	Unit	Accessibility	PDO Assignment	Variable Attribute	Saving	
UDINT	-	-	-	RO	No	Always	Yes	

This parameter displays the current date of RTC.

0x2624	Position Demand Internal Value							ALL
Variable Type	Setting Range	Initial Value	Unit	Accessibility	PDO Assignment	Variable Attribute	Saving	
DINT	-	-	pulse	RO	No	-	No	

This parameter represents the value input as a command during position control.

0x2625	Position Actual Internal Value						AL L
Variable Type	Setting Range	Initial Value	Unit	Accessi- bility	PDO Assignment	Variable Attribute	Sav- ing
DINT	-	-	pulse	RO	No	-	No

This parameter displays the position actual internal value in the unit of encoder pulse.

0x2626	Cumulative Hours of Use						AL L
Variable Type	Setting Range	Initial Value	Unit	Accessi- bility	PDO Assignment	Variable Attribute	Sav- ing
UDINT	-	-	Hour	RO	No	-	No

This parameter displays the power input time of the drive.

0x2627	Number of Inrush Current Switching						AL L
Variable Type	Setting Range	Initial Value	Unit	Accessi- bility	PDO Assignment	Variable Attribute	Sav- ing
DINT	-	-	Hour	RO	No	-	Yes

This parameter displays the inrush current generated during power ON/OFF in a counter.

0x2628	Number of Dynamic Brake Switching						AL L
Variable Type	Setting Range	Initial Value	Unit	Accessi- bility	PDO Assignment	Variable Attribute	Sav- ing
DINT	-	-	-	RO	No	-	Yes

This parameter displays the DB operation count.

0x2629	Position Demand Value						AL L
Variable Type	Setting Range	Initial Value	Unit	Accessi- bility	PDO Assignment	Variable Attribute	Sav- ing
DINT	-	-	UU	RO	No	-	No

This parameter displays the position demand value in the position unit (UU) specified by the user.

0x262A	Position Actual Value						ALL
Variable Type	Setting Range	Initial Value	Unit	Accessi bility	PDO Assignment	Variable Attribute	Savin g
DINT	-	-	UU	RO	No	-	No

This parameter displays the actual position value in a user-defined position unit (UU).

0x262B	Following Error Actual Value						ALL
Variable Type	Setting Range	Initial Value	Unit	Accessi bility	PDO Assignment	Variable Attribute	Savin g
DINT	-	-	UU	RO	No	-	No

This parameter displays the actual position error during position control.

0x262C	Torque Demand Value						ALL
Variable Type	Setting Range	Initial Value	Unit	Accessi bility	PDO Assignment	Variable Attribute	Savin g
INT	-	-	0.1%	RO	No	-	No

This parameter displays the current torque demand value in the unit of 0.1% of the motor's rated torque.

0x262D	Torque Actual Value						ALL
Variable Type	Setting Range	Initial Value	Unit	Accessi bility	PDO Assignment	Variable Attribute	Savin g
INT	-	-	0.1%	RO	No	-	No

This parameter displays the actual torque value generated by the drive in increments of 0.1% of the rated torque.

## 14.9 Procedure and Alarm history (0x2700~)

0x2700	Procedure Command Code						ALL
Variable Type	Setting Range	Initial Value	Unit	Accessibility	PDO Assignment	Variable Attribute	Saving
UINT	0 to 0xFFFF	0	-	RW	No	-	No

You can run various procedures with the following procedure command codes and command arguments. Make sure to enter correct a command argument value prior to entering a command code because the drive refers to the command argument for the command code input.

Command Codes	Command Arguments	Run Procedures
Manual Jog (0x0001)	1	Servo on
	2	Servo off
	3	Positive (+) driving (0x2300)
	4	Negative (-) driving (0x2300)
	5	Zero speed stop
Program Jog (0x0002)	1	Servo on
	2	Servo off
	3	Start operation
	4	Zero speed stop (server on maintained)
Servo Alarm History Reset (0x0003)	1	
Off-line Auto Tuning (0x0004)	1	Start auto tuning
Index Pulse Search (0x0005)	1	Servo on
	2	Servo off
	3	Positive (+) search (0x230C)
	4	Negative (-) search (0x230C)
	5	Zero speed stop
Absolute Encoder Reset (0x0006)	1	Absolute Encoder Reset
Instantaneous Maximum Operation Overload Reset (0x0007)	1	Resets the instantaneous maximum operation overload (0x2604) value
Phase Current Offset Tuning	1	Phase current offset tuning (U/V/W-phase offsets are stored in

(0x0008)		0x2015~0x2017, respectively. If an offset is abnormally large, AL-15 is generated)
Software reset (0x0009)	1	Software reset
Commutation (0x000A)	1	Perform commutation

0x2701	Procedure Command Argument						ALL
Variable Type	Setting Range	Initial Value	Unit	Accessibility	PDO Assignment	Variable Attribute	Saving
UINT	0 to FFFF <sub>hex</sub>	0	-	RW	No	-	No

0x2702	Servo Alarm History						ALL
SubIndex 0		Number of entries					
Variable Type	Setting Range	Initial Value	Unit	Accessibility	PDO Assignment	Variable Attribute	Saving
STRING	-	16	-	RO	No	-	No
SubIndex 1		Alarm Code 1 (newest)					
Variable Type	Setting Range	Initial Value	Unit	Accessibility	PDO Assignment	Variable Attribute	Saving
STRING	-	-	-	RO	No	-	No
SubIndex 2		Alarm Code 2					
Variable Type	Setting Range	Initial Value	Unit	Accessibility	PDO Assignment	Variable Attribute	Saving
STRING	-	-	-	RO	No	-	No
SubIndex 3		Alarm Code 3					
Variable Type	Setting Range	Initial Value	Unit	Accessibility	PDO Assignment	Variable Attribute	Saving
STRING	-	-	-	RO	No	-	No
SubIndex 4		Alarm Code 4					
Variable Type	Setting Range	Initial Value	Unit	Accessibility	PDO Assignment	Variable Attribute	Saving
STRING	-	-	-	RO	No	-	No
SubIndex 5		Alarm Code 5					
Variable Type	Setting Range	Initial Value	Unit	Accessibility	PDO Assignment	Variable Attribute	Saving

STRING	-	-	-	RO	No	-	No
SubIndex 6		Alarm Code 6					
Variable Type	Setting Range	Initial Value	Unit	Accessibility	PDO Assignment	Variable Attribute	Saving
STRING	-	-	-	RO	No	-	No
SubIndex 7		Alarm Code 7					
Variable Type	Setting Range	Initial Value	Unit	Accessibility	PDO Assignment	Variable Attribute	Saving
STRING	-	-	-	RO	No	-	No
SubIndex 8		Alarm Code 8					
Variable Type	Setting Range	Initial Value	Unit	Accessibility	PDO Assignment	Variable Attribute	Saving
STRING	-	-	-	RO	No	-	No
SubIndex 9		Alarm Code 9					
Variable Type	Setting Range	Initial Value	Unit	Accessibility	PDO Assignment	Variable Attribute	Saving
STRING	-	-	-	RO	No	-	No
SubIndex 10		Alarm Code 10					
Variable Type	Setting Range	Initial Value	Unit	Accessibility	PDO Assignment	Variable Attribute	Saving
STRING	-	-	-	RO	No	-	No
SubIndex 11		Alarm Code 11					
Variable Type	Setting Range	Initial Value	Unit	Accessibility	PDO Assignment	Variable Attribute	Saving
STRING	-	-	-	RO	No	-	No
SubIndex 12		Alarm Code 12					
Variable Type	Setting Range	Initial Value	Unit	Accessibility	PDO Assignment	Variable Attribute	Saving
STRING	-	-	-	RO	No	-	No
SubIndex 13		Alarm Code 13					
Variable Type	Setting Range	Initial Value	Unit	Accessibility	PDO Assignment	Variable Attribute	Saving
STRING	-	-	-	RO	No	-	No
SubIndex 14		Alarm Code 14					
Variable Type	Setting Range	Initial Value	Unit	Accessibility	PDO Assignment	Variable Attribute	Saving
STRING	-	-	-	RO	No	-	No



SubIndex 15		Alarm Code 15					
Variable Type	Setting Range	Initial Value	Unit	Accessi bility	PDO Assignment	Variable Attribute	Savin g
STRING	-	-	-	RO	No	-	No
SubIndex 16		Alarm Code 16(oldest)					
Variable Type	Setting Range	Initial Value	Unit	Accessi bility	PDO Assignment	Variable Attribute	Savin g
STRING	-	-	-	RO	No	-	No

This parameter represents the history of servo alarms generated in the drive. You can store up to 16 recently generated servo alarms. Sub-Index 1 is the latest alarm while the Sub-Index 16 is the oldest of the recently generated alarms. You can reset the servo alarm history by procedure commands.

## 14.10 Third Party Motor Support (0x2800~)

The following motor parameters are provided for driving motors manufactured by a third party in addition to our motor. To drive a third party's motor with our drive, you have to enter correct parameters. In this case, however, our company neither has performed any test for combinations of our drive and a third party motor nor provides any warranty for the motors' characteristics.

0x2800	[Third Party Motor] Type						ALL
Variable Type	Setting Range	Initial Value	Unit	Accessi- bility	PDO Assignment	Variable Attribute	Savin- g
UINT	0 to 1	0	-	RW	No	Power re-input	Yes

You can set the motor type.

Setting Value	Setting Details
0	Rotary motor
1	Linear motor

0x2801	[Third Party Motor] Number of Poles						ALL
Variable Type	Setting Range	Initial Value	Unit	Accessi- bility	PDO Assignment	Variable Attribute	Savin- g
UINT	2 to 1000	8	-	RW	No	Power re-input	Yes

You can set the number of motor poles. For a linear motor, set the value to 2.

0x2802	[Third Party Motor] Rated Current						ALL
Variable Type	Setting Range	Initial Value	Unit	Accessi- bility	PDO Assignment	Variable Attribute	Savin- g
FP32	-	2.89	Arms	RW	No	Power re-input	Yes

You can set the rated current of the motor.

0x2803	[Third Party Motor] Maximum Current						ALL
Variable Type	Setting Range	Initial Value	Unit	Accessi- bility	PDO Assignment	Variable Attribute	Savin- g
FP32	-	8.67	Arms	RW	No	Power re-input	Yes

You can set the maximum current of the motor.

0x2804	[Third Party Motor] Rated Speed						ALL
Variable Type	Setting Range	Initial Value	Unit	Accessi- bility	PDO Assignment	Variable Attribute	Savin- g
UINT	1 to 60000	3000	rpm	RW	No	Power re-input	Yes

You can set the rated speed of the motor. For a linear motor, the unit is mm/s.

0x2805	[Third Party Motor] Maximum Speed						ALL
Variable Type	Setting Range	Initial Value	Unit	Accessi- bility	PDO Assignment	Variable Attribute	Savin- g
UINT	1 to 60000	5000	rpm	RW	No	Power re-input	Yes

You can set the maximum speed of the motor. For a linear motor, the unit is mm/s.

0x2806	[Third Party Motor] Inertia						ALL
Variable Type	Setting Range	Initial Value	Unit	Accessi- bility	PDO Assignment	Variable Attribute	Savin- g
FP32	-	0.321	Kg.m <sup>2</sup> . 10 <sup>-4</sup>	RW	No	Power re-input	Yes

You can set the motor inertia. For a linear motor, set the weight of the rotor. The unit is kg.

0x2807	[Third Party Motor] Torque Constant						ALL
Variable Type	Setting Range	Initial Value	Unit	Accessi- bility	PDO Assignment	Variable Attribute	Savin- g
FP32	-	0.46	Nm/A	RW	No	Power re-input	Yes

You can set the torque constant of the motor. For a linear motor, set a force constant. The unit is N/A.

0x2808	[Third Party Motor] Phase Resistance						ALL
Variable Type	Setting Range	Initial Value	Unit	Accessi bility	PDO Assignment	Variable Attribute	Savin g
FP32	-	0.82	ohm	RW	No	Power re-input	Yes

You can set the phase resistance (= resistance between lines ÷ 2) of the motor.

0x2809	[Third Party Motor] Phase Inductance						ALL
Variable Type	Setting Range	Initial Value	Unit	Accessi bility	PDO Assignment	Variable Attribute	Savin g
FP32	-	3.66	mH	RW	No	Power re-input	Yes

You can set the phase inductance (= inductance between lines ÷ 2) of the motor.

0x280A	[Third Party Motor] TN Curve Data 1						ALL
Variable Type	Setting Range	Initial Value	Unit	Accessi bility	PDO Assignment	Variable Attribute	Savin g
UINT	1 to 60000	3000	rpm	RW	No	Power re-input	Yes

You can set the data of the motor speed/torque curve. Enter the maximum speed for when the maximum torque(for a linear motor, the maximum thrust) is output. For a linear motor, the unit is mm/s.

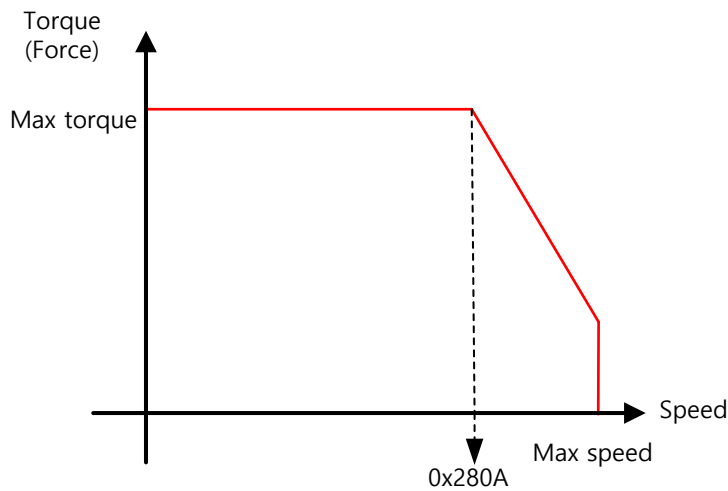

0x280B	[Third Party Motor] TN Curve Data 2						ALL
Variable Type	Setting Range	Initial Value	Unit	Accessi- bility	PDO Assignment	Variable Attribute	Savin- g
FP32	-	100.0	%	RW	No	Power re-input	Yes

You can set the data of the motor speed/torque curve. Enter a torque (thrust for a linear motor) which can be output at the maximum speed in percentage (%) relative to the maximum torque.

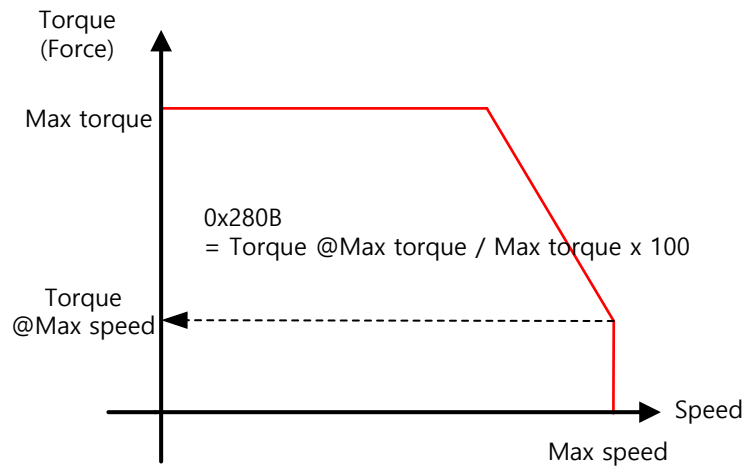

0x280C	[Third Party Motor] Hall Offset						ALL
Variable Type	Setting Range	Initial Value	Unit	Accessi- bility	PDO Assignment	Variable Attribute	Savin- g
UINT	0 to 360	0	deg	RW	No	Power re-input	Yes

The offset of the hall sensor set for the initial angle of a 3rd party motor may vary depending on manufacturer. For this, you must check the hall sensor offset and make a correct setting.

## 14.11 Index Objects(Ox3000~)

0x3000	Control Mode						ALL
Variable Type	Setting Range	Initial Value	Unit	Accessibility	Communication Address	Variable Attribute	Saving
UINT	0 to 9	1	-	RW		Power re-input	Yes

You can set the position control mode of the drive.

Setting Values	Setting Details
0	Indexing Position Mode
1	Pulse Input Position Mode
2	Velocity Mode
3	Torque Mode
4	Pulse Input Position Operation & Indexing Position Operation
5	Pulse Input Position Operation & Velocity Mode
6	Pulse Input Position Operation & Torque Mode
7	Velocity Mode & Torque Mode
8	Indexing Position Mode & Velocity Mode
9	Indexing Position Mode & Torque Mode

0x3001	Coordinate Select						ALL
Variable Type	Setting Range	Initial Value	Unit	Accessibility	Communication Address	Variable Attribute	Saving
UINT	0 to 1	0	-	RW		Power re-input	Yes

You can set the coordinate system to be used for indexing position control of the drive.

Setting Values	Setting Details
0	Use the linear coordinate method
1	Use the rotary coordinate method

0x3002	Baud Rate Select						ALL
Variable Type	Setting Range	Initial Value	Unit	Accessibility	PDO Assignment	Variable Attribute	Saving
UINT	0 to 3	3	-	RW	No	Power re-input	Yes

You can set the RS-422 serial communication speed between the upper level controller and the drive.

Setting Values	Setting Details
0	9600[bps]
1	19200[bps]
2	38400[bps]
3	57600[bps]

0x3003	Pulse Input Logic Select						ALL
Variable Type	Setting Range	Initial Value	Unit	Accessibility	PDO Assignment	Variable Attribute	Saving
UINT	0 to 5	0	-	RW	No	Power re-input	Yes

You can set the logic of the pulse train input from the upper level controller. The following are the forms of input pulses and the rotation directions of the logic.

Setting Values	Setting Details
0	Phase A + Phase B positive logic
1	CW + CCW positive logic
2	Pulse + sign positive logic
3	Phase A + Phase B negative logic
4	CW + CCW negative logic
5	Pulse + sign negative logic

0x3004	Pulse Input Filter Select						ALL
Variable Type	Setting Range	Initial Value	Unit	Accessibility	PDO Assignment	Variable Attribute	Saving
UINT	0 to 15	7	-	RW	No	Power re-input	Yes

You can set the frequency band of the digital filter set for the pulse input.

The frequency bands are determined based on the input pulse width in accordance with the digital filter's characteristics.

Setting Values	Setting Details
0	50[MHz](NO Filter)
1	25[MHz]
2	12.5[MHz]
3	6.25[MHz]
4	4.167[MHz]
5	3.125[MHz]
6	2.083[MHz]
7	1.562[MHz]
8	1.042[MHz]
9	0.781[MHz]
10	625[kHz]
11	521[kHz]
12	391[kHz]
13	313[kHz]
14	260[kHz]
15	195[kHz]

0x3005	PCLEAR Mode Select						ALL
Variable Type	Setting Range	Initial Value	Unit	Accessibility	PDO Assignment	Variable Attribute	Saving
UINT	0 to 2	0	-	RW	No	Always	Yes

You can set the operation mode during input of position pulse clear (PCLR) signal.

Setting Values	Setting Details
0	Operate in Edge Mode
1	Operate in Level Mode (torque: maintained)
2	Operate in Level Mode (torque: 0)



0x3006	Encoder Output Pulse						ALL
Variable Type	Setting Range	Initial Value	Unit	Accessi- bility	PDO Assignment	Variable Attribute	Savin- g
UDINT	0 to 2147483647	10000	pulse	RW	No	Power re-input	Yes

You can set the count of pulses to be output per motor rotation when the encoder signal is sent from the drive to the outside.

The encoder signal output pulse from the drive is a value multiplied by 4, and when the initial value is set to 10000, AO, /AO, BO, and /BO are output at 2500 [Pulse] each..

The rotation speed of the motor that can be output is limited depending on the setting value of the number of encoder output pulses per revolution, so an appropriate value must be set.

Maximum frequency of encoder output pulse is 1[MHz]. So if you set the value of encoder output pulse, you should apply below the formula to get appropriate value. For example, maximum speed of some machine is 2000[rpm]. You can set the parameter value until 30000.

$$\text{Maximum Value of Encoder Output Pulse} = \frac{60 \times 10^6 [\text{Hz}]}{\text{Motor Maximum Speed Operating in the Device} [\text{rpm}]} \times \frac{\text{Electric Gear Denominator}}{\text{Electric Gear Denominator}}$$

0x3007	Encoder Output Mode						ALL
Variable Type	Setting Range	Initial Value	Unit	Accessi- bility	PDO Assignment	Variable Attribute	Savin- g
UINT	0 to 1	0	-	RW	No	Power re-input	Yes

L7C Series does not provide this function. Only the line drive method supports the encoder output mode.

0x3008	Start Index Number (0~63)						ALL
Variable Type	Setting Range	Initial Value	Unit	Accessibility	PDO Assignment	Variable Attribute	Saving
UINT	0 to 64	0	-	RW	No	Always	Yes

You can set the index number (0-63) to start index position operation.

If the setting value is 64, the index number is determined by ISEL0~ISEL5 of digital input.

Index No	ISEL Input Signal					
	ISEL5	ISEL4	ISEL3	ISEL2	ISEL1	ISEL0
0	X	X	X	X	X	X
1	X	X	X	X	X	0
2	X	X	X	X	0	X
3	X	X	X	X	0	0
4	X	X	X	0	X	X
...						
60	0	0	0	0	X	X
61	0	0	0	0	X	0
62	0	0	0	0	0	X
63	0	0	0	0	0	0

0x3009	Index Buffer Mode						ALL
Variable Type	Setting Range	Initial Value	Unit	Accessibility	PDO Assignment	Variable Attribute	Saving
UINT	0 to 1	1	-	RW	No	Always	Yes

You can set how many times the START (operation start) signal is remembered during indexing position operation.

Setting Values	Setting Details
0	Double buffer set (Remembers twice)
1	Single buffer set (Remembers once)

0x300A	IO Signal Configuration						ALL
Variable Type	Setting Range	Initial Value	Unit	Accessibility	PDO Assignment	Variable Attribute	Saving
UINT	0 to 0xFFFF	0	-	RW	No	Always	Yes

You can set different functions in input/output ports by selecting different bits.

Bits	Setting Details
0	<p>You can set the operation of IOOUT0~5 signals used in indexing position operation.</p> <p>When you set the value to 0, the applicable IOOUT signal is output during indexing position operation. When indexing position operation is completed, a completed IOOUT signal is output.</p> <p>When you set the value to 1, the previously completed IOOUT signal is output during indexing position operation. When indexing position operation is completed, a completed IOOUT signal is output.</p>
1	<p>You can set the operation of the START signal used in indexing position operation.</p> <p>When you set the value to 0, only positive edges recognize the START signal.</p> <p>When you set the value to 1, only both edges recognize the START signal.</p>
2	<p>You can set the operation of the JSTART and JDIR signals.</p> <p>When you set the value to 0, operation is based on the JSTART and JDIR signals.</p> <p>When you set the value to 1, operation is based on the PJOG and NJOG signals.</p> <p>Refer to Section 4.3, "Functions of Index Input Signals"</p>
3	<p>You can set the operation of velocity override used in indexing position operation.</p> <p>When you set the value to 0, velocity override is applied for index ranges.</p> <p>When you set the value to 1, velocity override is applied real-time.</p>
4	<p>You can set the registration operation in indexing position operation.</p> <p>When you set the value to 0, absolute/relative operation is performed according to the registration type of the index during indexing position operation.</p> <p>When you set the value to 1, absolute/relative operation is performed by the REGT Configuration [0x300B] value.</p>
5	<p>You can set the operation of the Software Position Limit function in jog operation.</p> <p>When you set the value to 0, the Software Position Limit function in jog operation is deactivated. When you set the value to 1, the function in jog mode is activated.</p>
6	<p>You can set the operation of ORG signal output during homing.</p> <p>When you set the value to 0, the ORG signal after homing operation and servo off is maintained. When you set the value to 1, the ORG signal output is turned off after homing operation and servo off.</p>

0x300B	REGT Configuration						ALL
Variable Type	Setting Range	Initial Value	Unit	Accessibility	PDO Assignment	Variable Attribute	Saving
UINT	0 to 1	0	-	RW	No	Always	Yes

You can set the operation for REGT signals in Registration Relative Move.

Setting Values	Setting Details
0	The new target position after REGT signal input operates as a relative value in relation to the current position value.
1	The new target position after REGT signal input operates as an absolute value in relation to the current position value.
2	Reserved
3	Reserved
4	Reserved
5	Reserved

The user can adjust the setting value to perform the movement with absolute or relative operation for REG signal input.

I/O Signal Configuration [0x300A]

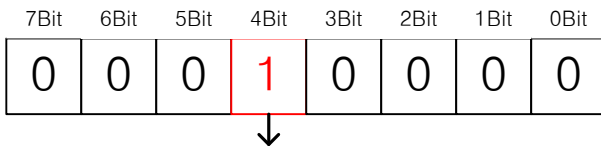

Bit setting values	Setting Details
0	Absolute/relative operation according to the index type of Registration Mode.
1	Absolute/relative operation according to the setting value of 0x300B

Be aware that this function only operates when the 4th bit of 0x300A is SET. For example, when you set the index type of index 0 to Registration Absolute and 0x300B to 0 and if the 4th bit of 0x300A is 1 (Set), a movement of 20000 [UU] is made by relative operation. If the bit is 0(Reset) absolute operation performs a movement to the 20000 [UU] position.

	<b>Index 0</b>
Index Type	Registration Absolute
Distance [UU]	5242880
Velocity [UU/s]	2621440
Acceleration [UU/s^2]	26214400
Deceleration [UU/s^2]	26214400
Registration Distance [UU]	20000
Registration Velocity [UU/s]	2621440
Repeat Count	1
Dwell Time [ms]	0
Next Index	0
Action	Next Index
	Copy    Paste

4th bit in 0x300A	Movement result according to the setting value
0	Registration moved to index type
1	Moved according to the setting value of 0x300B

0x300C	Electric Gear Numerator 1						ALL
Variable Type	Setting Range	Initial Value	Unit	Accessi- bility	PDO Assignment	Variable Attribute	Savin- g
UDINT	1 to 2147483647	1	-	RW	No	Power re-input	Yes

You can set Electric Gear Numerator 1.

0x300D	Electric Gear Numerator 2						ALL
Variable Type	Setting Range	Initial Value	Unit	Accessi- bility	PDO Assignment	Variable Attribute	Savin- g
UDINT	1 to 2147483647	1	-	RW	No	Power re-input	Yes

You can set Electric Gear Numerator 2.

0x300E	Electric Gear Numerator 3						ALL
Variable Type	Setting Range	Initial Value	Unit	Accessi- bility	PDO Assignment	Variable Attribute	Savin- g
UDINT	1 to 2147483647	1	-	RW	No	Power re- input	Yes

You can set Electric Gear Numerator 3.

0x300F	Electric Gear Numerator 4						ALL
Variable Type	Setting Range	Initial Value	Unit	Accessi- bility	PDO Assignment	Variable Attribute	Savin- g
UDINT	1 to 2147483647	1	-	RW	No	Power re- input	Yes

You can set Electric Gear Numerator 4.

0x3010	Electric Gear Denominator 1						ALL
Variable Type	Setting Range	Initial Value	Unit	Accessi- bility	PDO Assignment	Variable Attribute	Savin- g
UDINT	1 to 2147483647	1	-	RW	No	Power re- input	Yes

You can set Electric Gear Denominator 1.

0x3011	Electric Gear Denominator 2						ALL
Variable Type	Setting Range	Initial Value	Unit	Accessi- bility	PDO Assignment	Variable Attribute	Savin- g
UDINT	1 to 2147483647	1	-	RW	No	Power re- input	Yes

You can set Electric Gear Denominator 2.

0x3012	Electric Gear Denominator 3						ALL
Variable Type	Setting Range	Initial Value	Unit	Accessi- bility	PDO Assignment	Variable Attribute	Savin- g
UDINT	1 to 2147483647	1	-	RW	No	Power re- input	Yes

You can set Electric Gear Denominator 3.

0x3013	Electric Gear Denominator 4						ALL
Variable Type	Setting Range	Initial Value	Unit	Accessi- bility	PDO Assignment	Variable Attribute	Savin- g
UDINT	1 to 2147483647	1	-	RW	No	Power re- input	Yes

You can set Electric Gear Denominator 4.

0x3014	Electric Gear Mode						ALL
Variable Type	Setting Range	Initial Value	Unit	Accessi- bility	PDO Assignment	Variable Attribute	Savin- g
UINT	0 to 1	0	-	RW	No	Power re- input	Yes

You can select the electric gear mode in Pulse Input Position Mode to use the electric gear offset function.

When you set the value to 0, you can select among Electric Gear Ratio 1~4 to use it. When you set the value to 1, you can apply offset [0x3015] to Electric Gear Numerator 1.

0x3015	Electric Gear Offset						ALL
Variable Type	Setting Range	Initial Value	Unit	Accessibility	PDO Assignment	Variable Attribute	Saving
INT	-327681 to 32767	0	-	RW	No	Power re-input	Yes

You can set the electric gear offset value. When you set [0x3014] Electric Gear Mode to 1, the offset is applied to the numerator of Electric Gear Ratio 1 by EGEAR1 and EGEAR2.

- EGEAR1 contact LOW->HIGH: [0x3015] setting value increases. The numerator value of electric gear ratio 1 increases

- EGEAR2 contact LOW->HIGH: [0x3015] setting value decreases. The numerator value of electric gear ratio 1 decreases

ex) If you input "12000" for the numerator and "5000" for the denominator and turn on the 'EGEAR1' contact, the [0x300C] setting value increases by 1. If you turn on the 'EGEAR2' contact, the [0x300C] setting value decreases by 1 and is stored in the [0x300C] parameter. If the offset is 2, the electronic gear ratio for operation changes from 12000/5000 to 12002/5000. If the offset is -2, the electronic gear ratio for operation changes from 12000/5000 to 11998/5000.

0x3016	Position Limit Function						ALL
Variable Type	Setting Range	Initial Value	Unit	Accessibility	PDO Assignment	Variable Attribute	Saving
UINT	0 to 1	0	-	RW	No	Power re-input	Yes

You can select the clear operation type of position command pulse for NOT and POT contacts. When you set the value to 1, the input pulse keeps accumulating while the contact is turning on, often leading to occurrence of a position error alarm. However, if you set a large value for Following Error Window [0x6065], the motor can move as much as the accumulated position error value at the maximum speed while the contact is turning off. Be aware of this when you use the parameter.

Setting Values	Setting Details
0	Ignores input pulses when NOT and POT contacts are on
1	Receives input pulses and saves them in the buffer when NOT and POT contacts are on

0x3017	Backlash Compensation						ALL
Variable Type	Setting Range	Initial Value	Unit	Accessi- bility	PDO Assignment	Variable Attribute	Savin- g
UINT	0 to 1000	0	-	RW	No	Power re- input	Yes

You can set the backlash compensation during pulse input operation.

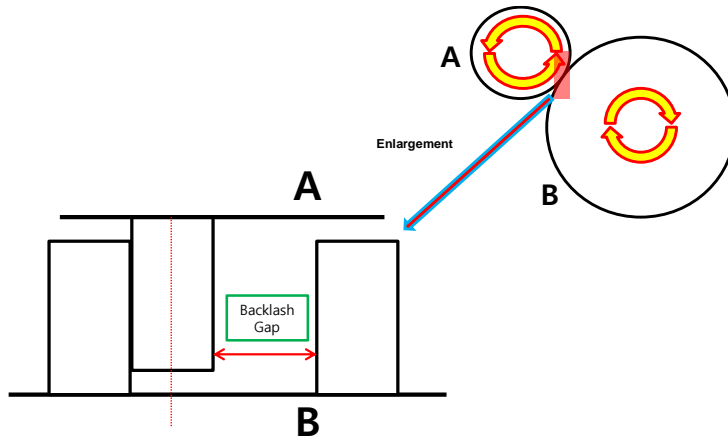

Generally, mechanical backlash gaps occur in a toothed wheel type. If this is ignored during operation, noise or vibration may occur. [0x3017] sets backlash compensation by converting the amount of backlashes to number of pulses if the positioning is interrupted by mechanical backlashes during position operation. When you input a setting value and turn on the servo, the backlash compensation value is applied in the initial movement direction (set for the opposite direction as much as the backlash).



0x3018	Homing Method						ALL
Variable Type	Setting Range	Initial Value	Unit	Accessibility	PDO Assignment	Variable Attribute	Saving
SINT	-128 to 127	34	-	RW	No	Always	Yes

You can set the homing method. For more information, refer to Section 9.1, "Homing."

Setting Values	Description
0	Disabled
1	Homing using index pulse and reverse limit contact
2	Homing using index pulse and forward limit contact
7 to 14	Homing using index pulse and home contact
24	Same as method 8 (does not use index pulse)
28	Same as method 12 (does not use index pulse)
33, 34	Homing by index pulse
35	Homing to the current position
-1	Homing using the negative stopper and index pulse
-2	Homing using the positive stopper and index pulse
-3	Homing using the negative stopper only
-4	Homing using the positive stopper only

0x3019	Home Offset						ALL
Variable Type	Setting Range	Initial Value	Unit	Accessibility	PDO Assignment	Variable Attribute	Saving
DINT	-2147483648 to 2147483647	0	UU	RW	No	Always	Yes

You can set the offset value for the origin of the absolute encoder or absolute external scale and the zero position of the actual position value (0x262A).

Home Offset input value	Home Offset[0x607C] > 0	Home Offset[0x607C] < 0
Motor movement direction	CW	CCW

- Incremental Encoder

If the home position is found or at the home position, the position reached by the home offset value becomes the zero position.

- Absolute Encoder

If the absolute encoder is connected, the home offset value is added to the absolute position (actual position value).

0x301A	Speed during search for switch						ALL
Variable Type	Setting Range	Initial Value	Unit	Accessibility	PDO Assignment	Variable Attribute	Saving
DINT	0 to 0x40000000	500000	UU/s	RW	No	Always	Yes

Set the switch search speed when homing .

0x301B	Speed during search for zero						ALL
Variable Type	Setting Range	Initial Value	Unit	Accessibility	PDO Assignment	Variable Attribute	Saving
DINT	0 to 0x40000000	100000	UU/s	RW	No	Always	Yes

Set the Zero switch search speed when homing..

0x301C	Homing Acceleration						ALL
Variable Type	Setting Range	Initial Value	Unit	Accessibility	PDO Assignment	Variable Attribute	Saving
UDINT	0 to 0x40000000	200000	UU/s <sup>2</sup>	RW	No	Always	Yes

You can set the operation acceleration for homing.

0x301D	Following Error Window						ALL
Variable Type	Setting Range	Initial Value	Unit	Accessibility	PDO Assignment	Variable Attribute	Saving
UDINT	0 to 0x3FFFFFFF	600000	UU	RW	No	Always	Yes

You can set the positional error range for checking Following Error(AL-51).

Check the encoder resolution of the motor before operation and set an appropriate value.

ex) if the setting value of encoder pulse[0x2002] per revolution of the parameter is 12000 and the positional error range is set to 3 motor revolutions, the result value is 36000.

0x301E	Following Error Timeout						ALL
Variable Type	Setting Range	Initial Value	Unit	Accessibility	PDO Assignment	Variable Attribute	Saving
UINT	0 to 65535	0	ms	RW	No	Always	Yes

You can set the timeout value for Following Error(AL-51) check.

0x301F	Velocity Window Time						ALL
Variable Type	Setting Range	Initial Value	Unit	Accessibility	PDO Assignment	Variable Attribute	Saving
UINT	0 to 65535	0	ms	RW	No	Always	Yes

You can set the velocity window time. If the difference between the target velocity and actual velocity is maintained within the INSPD output range (0x2406) for the duration of the velocity window time (0x301F), an INSPD signal is output.

0x3020	Software Position Min Limit						ALL
Variable Type	Setting Range	Initial Value	Unit	Accessibility	PDO Assignment	Variable Attribute	Saving
DINT	-1073741824 to 1073741823	-1000000000	-	RW	No	Always	Yes

0x3021	Software Position Max Limit						ALL
Variable Type	Setting Range	Initial Value	Unit	Accessibility	PDO Assignment	Variable Attribute	Saving
DINT	-1073741824 to 1073741823	1000000000	-	RW	No	Always	Yes

You can set the software position limit. The parameter limits the ranges of the position demand value (0x2629) and the actual position value (0x262A) and checks the new target positions for the setting values during every cycle.

The minimum software limit value is the reverse rotation limit. The maximum software limit value is the forward rotation limit.

0x3022	Positive Torque Limit Value						ALL
Variable Type	Setting Range	Initial Value	Unit	Accessibility	PDO Assignment	Variable Attribute	Saving
UINT	0 to 3000	5000	0.1%	RW	Yes	Always	Yes

You can set the positive torque value limit.

0x3023	Negative Torque Limit Value						ALL
Variable Type	Setting Range	Initial Value	Unit	Accessibility	PDO Assignment	Variable Attribute	Saving
UINT	0 to 3000	5000	0.1%	RW	Yes	Always	Yes

You can set the negative torque value limit.

0x3024	Quick Stop Deceleration						ALL
Variable Type	Setting Range	Initial Value	Unit	Accessibility	PDO Assignment	Variable Attribute	Saving
UDINT	0 to 0x7FFFFFFF	200000	UU/s <sup>2</sup>	RW	No	Always	Yes

When you input STOP signal of digital input, the motor decelerates according to Quick Stop deceleration value. The parameter calculates the positions of STOP signal input and stop target and decelerates to a stop at the exact position. In adjusting the gear ratio, you need to adjust the Quick Stop value that is appropriate for the gear ratio. Since an accurate deceleration and stop are carried out when you input a value of 32 [Bit] of lower, make sure to input a value within that range.

The following formula is used to calculate the target position of Quick Stop Deceleration.

$$\text{Target Position}[UU] = \frac{\text{Velocity}^2[UU^2/\text{sec}^2]}{2 \times \text{Quick Stop Deceleration}[UU/\text{sec}^2]}$$

The following is the formula for the target position value when you run index 0 at 300 [rpm] and input 2000000 [UU/sec<sup>2</sup>] for the [0x3024] address and input a STOP signal.

$$\text{Target Position}[UU] = \frac{2621440^2}{2 \times 2000000} = 1717986[UU]$$

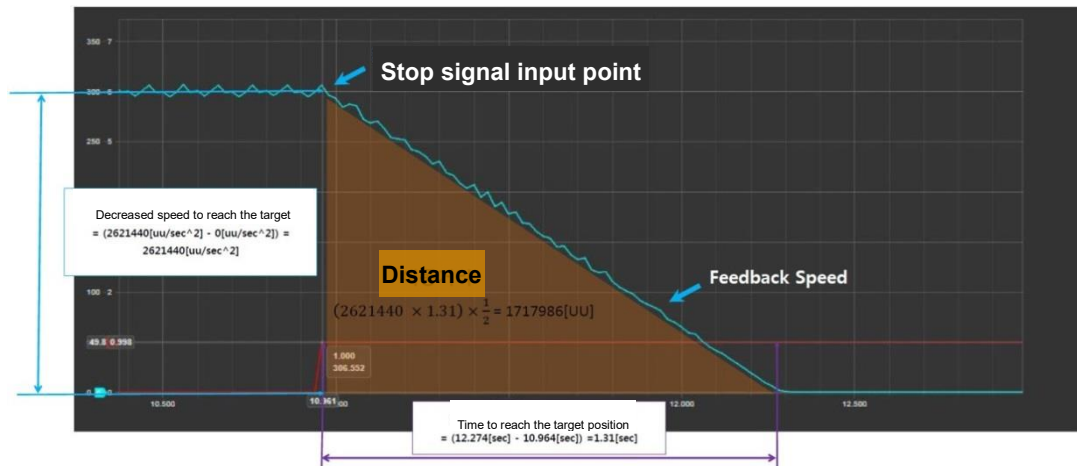

The target position is equal to the area of the distance shown in the figure above. If you want to stop the motor for approximately 2 seconds after inputting STOP signal while the motor is running at 300 rpm in index mode, you can calculate Quick Stop Deceleration as follows.

$$\text{Target Position} = (2621440[\text{UU}/\text{sec}] \times 2[\text{sec}]) \times \frac{1}{2} = 2621440[\text{UU}]$$

$$\frac{2621440^2[\text{UU}^2/\text{sec}^2]}{2 \times 2621440[\text{UU}]} = 1310720[\text{UU}/\text{sec}^2]$$

In other words, Quick Stop Deceleration function enables you to stop the motor exactly at the specified position or time when you input the STOP signal.

- The following parameters can be controlled in the loader window, but you can edit the parameters more conveniently if you use Drive CM (PC program).

0x3100	Index00~Index63						
~							
0x313F							
SubIndex 0		Number of Entries					
Variable Type	Setting Range	Initial Value	Unit	Accessibility	PDO Assignment	Variable Attribute	Saving
USINT	-	11	-	RO	No	-	No
SubIndex 1		Index Type					
Variable Type	Setting Range	Initial Value	Unit	Accessibility	PDO Assignment	Variable Attribute	Saving
UINT	0 to 10	1	-	RW	No	Always	Yes
SubIndex 2		Distance					
Variable Type	Setting Range	Initial Value	Unit	Accessibility	PDO Assignment	Variable Attribute	Saving
DINT	-2147483648 to 2147483647	100000	UU	RW	No	Always	Yes
SubIndex 3		Velocity					
Variable Type	Setting Range	Initial Value	Unit	Accessibility	PDO Assignment	Variable Attribute	Saving

Type					Assignment	Attribute	
DINT	1 to 2147483647	100000	UU/s	RW	No	Always	Yes
SubIndex 4		Acceleration					
Variable Type	Setting Range	Initial Value	Unit	Accessibility	PDO Assignment	Variable Attribute	Saving
DINT	1 to 2147483647	1000000	UU/s <sup>2</sup>	RW	No	Always	Yes
SubIndex 5		Deceleration					
Variable Type	Setting Range	Initial Value	Unit	Accessibility	PDO Assignment	Variable Attribute	Saving
DINT	1 to 2147483647	1000000	UU/s <sup>2</sup>	RW	No	Always	Yes
SubIndex 6		Registration Distance					
Variable Type	Setting Range	Initial Value	Unit	Accessibility	PDO Assignment	Variable Attribute	Saving
DINT	-2147483648 to 2147483647	100000	UU	RW	No	Always	Yes
SubIndex 7		Registration Velocity					
Variable Type	Setting Range	Initial Value	Unit	Accessibility	PDO Assignment	Variable Attribute	Saving
DINT	1 to 2147483647	1000000	UU/s	RW	No	Always	Yes
SubIndex 8		Repeat Count					
Variable Type	Setting Range	Initial Value	Unit	Accessibility	PDO Assignment	Variable Attribute	Saving
UINT	1 to 65535	1	-	RW	No	Always	Yes
SubIndex 9		Dwell Time					
Variable Type	Setting Range	Initial Value	Unit	Accessibility	PDO Assignment	Variable Attribute	Saving
UINT	0 to 65535	200	ms	RW	No	Always	Yes
SubIndex 10		Next Index					
Variable Type	Setting Range	Initial Value	Unit	Accessibility	PDO Assignment	Variable Attribute	Saving
UINT	0 to 63	1	-	RW	No	Always	Yes
SubIndex 11		Action					
Variable Type	Setting Range	Initial Value	Unit	Accessibility	PDO Assignment	Variable Attribute	Saving
UINT	0 to 2	2	-	RW	No	Always	Yes

# 15. Maintenance and Inspection

## 15.1 Diagnosing Abnormalities and Troubleshooting

An alarm or warning is generated if a problem occurs during operation. If this happens, find the applicable code and take a proper action. If the problem persists after taking such a measure, contact our service center.

## 15.2 Precautions

1. When measuring the motor voltage: PWM controls the voltage output from the servo to the motor. Because of this, waves are output in the form of pulses. Use a rectifier voltmeter for accurate measurements because different meters may produce largely different results.
2. When measuring the motor current: Connect and use a moving-iron-type ampere meter because the motor's reactance smooths the pulse waveform to produce partial sine waves.
3. When measuring the electric power: Use an electro-dynamo-meter and measure based on the 3 power meter method.
4. Other gauges: When using an oscilloscope or digital voltmeter, do not allow them to touch the ground. Use an input current gauge of 1mA or lower.

## 15.3 Inspection Points

Be sure to start inspection approximately 10 minutes after power is turned off because the voltage charge left in the internal smoothing condenser may cause an accident.

### (1) Servo Motor Inspection

**⚠ Caution**

Be sure to start inspection approximately 10 minutes after power is turned off because the voltage charge left in the internal smoothing condenser may cause an accident.

When inspecting the servo, be sure to wait until the "charge" light completely goes off since some current remains in the main electrolytic condenser.

When using an absolute encoder, the multi-turn data of the encoder will be lost when replacing the motor and encoder cable, so perform origin operation after inspection.

Inspection Items	Inspection Time	Inspection and Handling	Notes
Vibration and sound check	Monthly	Touch the motor and listen to sounds.	The feel and sounds must be the same as usual.
Exterior check	Depends on the level of contamination or damage.	Clean the motor with a cloth or air.	-
Insulation resistance measurement	At least once a year	Disconnect the motor from the drive and measure insulation resistance. A normal resistance level is 10[MΩ] or higher. <small>Note 1)</small>	Contact our service center if resistance is lower than 10[MΩ].
Oil seal replacement	At least once every 5,000 hours	Remove the oil seal from the motor and replace it.	Only applies to motors with an oil seal.
General inspection	At least once every 20,000 hours or 5 years.	Contact our service center.	Do not disassemble the servo motor by yourself for cleaning.

주1) Measure the resistance between PE and one of the U, V and W power cables in the servo motor.

## (2) Servo Drive Inspection

Inspection Items	Inspection Time	Inspection Method	What to do for Abnormalities
Main body and boards cleaning	At least once a year	Check if there is any dust or oil on the components.	Clean it with air or a cloth.
Loose screws	At least once a year	Screws on the terminal board or connector must not be loose.	Tighten the screws.
Defective parts of the main body or control board	At least once a year	Check for discoloration, damage or disconnection caused by heat.	Contact our company.



## 15.4 Parts Replacement Cycle

Mechanical friction or aging of objects with certain characteristics may deteriorate performance of the following parts or cause them to malfunction. Therefore it is important to conduct regular maintenance checks and regular replacement.





1. Smoothing condenser: Ripple currents and other factors can cause this part to wear down. The lifespan of the condenser depends on the operating temperature and environmental conditions. It normally lasts for 10 years if used continuously in a normal air-conditioned environment. Inspect the condenser at least once each year because it can rapidly age over certain short periods of time (inspect at least once half a year as it approaches its end of life).
  - ※ Visual inspection criteria
    - a. The condition of the case: Check for enlargement of the sides and bottom.
    - b. The condition of the lid: Check for notable enlargement, severe cracks, or broken parts.
    - c. The condition of the explosion valve: Check for notable valve enlargement and check the operation status.
    - d. Also, regularly check whether the exterior is cracked, discolored, or leaking and whether there are any broken parts. The condenser is obsolete when its rated capacity degrades to 85% or lower.
2. Relays: Check for bad connection and wear and tear of the contacts caused by switching currents. A relay is obsolete when its accumulated number of switches reaches around 100,000 times, depending on the power capacity.
3. Motor bearings: Replace the bearings after 20,000 to 30,000 hours of operation at the rated speed under the rated load. Replace the bearings if abnormal sounds or vibrations are detected during inspection, depending on the operating conditions.





### [Standard Part Replacement Cycles]

Part Names	Standard Replacement Cycle	Replacement Method
Smoothing condenser	7~8 years	Replace (Determine after inspection)
Relays	-	Determine after inspection
Fuses	10 years	Replace
Aluminum electrolytic condensers on printed boards	5 years	Replace with new boards (Determine after inspection)
Cooling fans	4~5 years	Replace
Motor bearings	-	Determine after inspection
Motor oil seals	5,000 hours	Replace

## 15.5 Servo Alarms

If the drive detects a problem, it triggers a servo alarm and transition to the servo off state for a stop. In this case, the setting value of emergency stop (0x2013) is used to stop the drive.



Alarm Code Names	Causes	Inspection Items	Measures to Take
 IPM fault (Overcurrent (H/W))   Over current (Overcurrent (S/W))   Current limit exceeded (Overcurrent (H/W))	Motor cable abnormality	Check for abnormal wiring and short circuit.	Replace the motor cable.
	Encoder cable abnormality	Check for abnormal wiring and short circuit.	Replace the encoder cable.
	Parameter setting abnormality	Make sure that the setting values for motor ID [0x2000], encoder type [0x2001] and encoder format [0x2002] match the applied information on the motor label.	Modify the parameters so that they match the information on the motor label.
	Motor phase resistance inspection	Inspect resistance between motor lines (U-V, V-W, W-U below several $\Omega$ )	Replace the motor.
	Apparatus abnormality	Determine whether there are conflicts or binding among the apparatuses.	Inspect the apparatuses.
	Drive abnormality		If alarms occur continually after power re-input, replace the drive since there may be abnormalities in the drive.
 IPM temperature (IPM overheat)	Ambient temperature	Check if the ambient temperature exceeds 50[°C].	Lower the ambient temperature.
	Continual overload alarm	Check if the load is lower than 100% by the accumulated operation overload ratio value [0x2603].	Change the capacity of the drive and motor. Adjust gain.
	Highly frequent regenerative operation or continual regenerative operation	Check accumulated regenerative overload ratio [0x2606].	Adjust the setting value for regenerative resistance [0x2009]. Use an external regenerative resistance.
	Installation direction of the drive	Check the installation status of the drive.	Refer to Section 2. "Wiring and Connection ."
	Drive abnormality		If alarms occur continually after power re-input, replace the drive since there may be abnormalities in the drive.
 Current offset	Excessive setting of the motor's U and V Phase current offset	Check whether the U, V, W phase current offsets [0x2015] - [0x2017] are 5% of the rated current or higher.	Re-adjust phase current offset.

Alarm Code Names	Causes	Inspection Items	Measures to Take
(Current offset abnormality)	Drive abnormality		If alarms occur continually after phase current offset adjustment, replace the drive since there may be abnormalities in the drive.
 Continuous overload (Continuous overload abnormality)	Continuous operation with a load exceeding the rated value	Accumulated operation during constant velocity periods and pauses Check if the load is lower than 100% by the accumulated operation overload ratio value[0x2603].	Change the capacity of the motor and drive. Adjust gain.
	Motor brake abnormality	Check for opening of the motor brake during SVON.	Supply power to the motor brake.
	Parameter setting abnormality	Make sure that the setting values for motor ID [0x2000], encoder type [0x2001] and encoder format [0x2002] match the applied information on the motor label.	Modify the parameters so that they match the information on the motor label.
		Check the setting value of basic load ratio for overload detection [0x200F].	Set an appropriate value.
	Apparatus abnormality	Check for any abnormality during operation.	Inspect the apparatuses.
	Motor cable abnormality	Check for abnormal wiring and short circuit.	Replace the motor cable.
	Encoder cable abnormality	Check for abnormal wiring and short circuit.	Replace the encoder cable.
 Drive temperature 1 (Drive overheat 1)	Ambient temperature	Check if the ambient temperature exceeds 50[°C].	Lower the ambient temperature.
	Drive abnormality	Check if the displayed drive temperature 1 value [0x260B] is highly different than the ambient temperature in the normal state.	Replace the drive.
 Regenerative overload	Capacity exceeded due to highly frequent operation or continual regenerative operation.	Check accumulated regenerative overload ratio [0x2606].	Adjust the setting value for [0x2009]. Use an external regenerative resistance.
	Parameter setting abnormality	Check the setting values of [0x2009]~[0x200E].	Set an appropriate value.
	Main power input voltage abnormality	Check if the main power voltage is AC253 [V] or higher.	Re-inspect the main power source.
	Drive abnormality	Check for any heat in the regenerative resistance when it is not operating.	Replace the drive.
 Motor cable open (Motor cable disconnection)	Motor cable abnormality	Check for cable disconnection.	Replace the motor cable.
	Motor abnormality	Check for U, V, W short circuit inside the motor. (U-V, V-W, W-U)	Replace the motor.
	Drive abnormality		If alarms occur continuously while SVON is on, replace the

Alarm Code Names	Causes	Inspection Items	Measures to Take
			drive since there may be abnormalities in the drive.
<b>AL-25</b> Drive temperature 2 (Drive overheat 2)	Ambient temperature	Check if the ambient temperature exceeds 50[°C].	Lower the ambient temperature.
	Drive abnormality	In normal conditions, check if the drive temperature 2 [0x260C] is significantly different from the ambient temperature.	Replace the drive. Check if there is heat leakage inside the electric devices.
<b>AL-26</b> Encoder temperature (Encoder overheat)	Reserved		
<b>AL-30</b> Encoder communication (Serial encoder communication error)  <b>AL-31</b> Encoder cable open (Encoder cable disconnection)  <b>AL-32</b> Encoder data (Encoder data error)	Encoder cable abnormality	Check for disconnection, abnormal connection and short circuit.	Replace the encoder cable.
	Parameter setting abnormality	Make sure that the setting values for [0x2001] and [0x2002] match the applied information on the motor label.	Modify the parameters so that they match the information on the motor label. If modified information after saving the parameters is not applied, there may be abnormalities in the motor. In this case, replace the motor.
	Encoder abnormality		If alarms occur continually after power re-input, replace the motor since there may be abnormalities in the motor.
	Drive abnormality		If alarms occur continually after power re-input, replace the drive since there may be abnormalities in the drive.
<b>AL-33</b> Motor setting (Motor ID setting error)	Motor ID setting	The setting value for [0x2000] must match the applied information on the motor label.	Modify the parameters so that they match the information on the motor label. This alarm can be canceled after parameter modification when the power is on/off.
	Drive abnormality		If alarms occur continually after power re-input, replace the drive since there may be abnormalities in the drive.
<b>AL-34</b> Z Phase open (Encoder Z Phase disconnection)	Encoder cable abnormality	Check for abnormal wiring and short circuit.	Replace the encoder cable.
	Encoder abnormality		If alarms occur continually after power re-input, replace the motor since there may be abnormalities in the motor.
	Drive abnormality		If alarms occur continually after power re-input, replace the drive since there may be abnormalities in the drive.

Alarm Code Names	Causes	Inspection Items	Measures to Take
<b>AL-35</b> Low battery (Low voltage of encoder battery)	Parameter setting abnormality	Check the setting value of [0x2005].	To use an incremental type absolute encoder, set the value to 1 to disable alarms.
	Defective battery connection, unconnected	Check the battery connection status.	Connect the battery accurately.
	Low battery voltage	Check if the battery voltage is 3.3V or higher.	Replace the battery.
<b>AL-36</b> Preset Error (Encoder initialize)	Parameter setting error	Absolute encoder setting [0x2005] Check the setting value.	When you want to use an absolute encoder as an incremental encoder, if you set it to 1, no alarm will occur.
	Poor battery contact, not connected	Check battery connection status	After connecting the battery correctly, reset the alarm and then re-apply the power. Please reset the mechanical origin as the current position is reset.
	When initial encoder power is turned on	This may occur when power is turned on after initial wiring of the encoder.	After resetting the alarm, reconnect the power. Please reset the mechanical origin as the current position is reset.
<b>AL-40</b> Under voltage (Low voltage) *This alarm occurs when SVON is on.	Main power input voltage abnormality	Check if the main power voltage is single-phase AC170[V] or higher.	Re-inspect the main power source.
		Check if the value of [0x2605] is 280~320[V] when the main power input is normal.	Replace the drive.
	Lowered power voltage during operation	Check the wiring status of the main power.	Use a 3-phase voltage supply.
<b>AL-41</b> Over voltage	Main power input voltage abnormality	Check if the main power voltage is AC253 [V] or lower.	Re-inspect the main power source.
		Check if the value of [0x2605] is 280~320[V] when the main power input is normal.	Replace the drive.
	High external regenerative resistance	Check the operation conditions and the regenerative resistance value.	Review the regenerative resistance value taking into account the operation conditions and the load.
	Acceleration/deceleration setting values	Highly frequent acceleration/deceleration	Set a high value for acceleration/deceleration time.
	Drive abnormality		If alarms occur continually after power re-input, replace the drive since there may be abnormalities in the drive.
<b>AL-42</b> Main power fail	Main power input voltage abnormality	Check if the voltage between L1 and L2 phases is AC200-230[V].	Re-inspect the main power source.
	Parameter setting abnormality	Check the setting value of [0x2006] for the main power input.	For a warning, not an alarm, modify the setting value of [0x2006].
	Momentary power outage	Check the setting value of [0x2007].	Lower the setting value of [0x2007] or inspect the power source.
	Drive abnormality		If alarms occur continually after power re-input, replace the drive since there may be abnormalities in the drive.

Alarm Code Names	Causes	Inspection Items	Measures to Take
<b>AL43</b> Control power fail	Reserved		.
<b>AL50</b> Over speed limit	Motor cable abnormality	Check for abnormal wiring and short circuit.	Replace the motor cable.
	Encoder cable abnormality	Check for abnormal wiring and short circuit.	Replace the encoder cable.
	Parameter setting abnormality	Make sure that the setting values of [0x2000], [0x2001] and [0x2002] match the applied information on the motor label.	Modify the parameters so that they match the information on the motor label.
		Check the setting values of [0x300C]~[0x3013].	Set the electric gear ratio to a low value.
		Check the setting values of [0x2100]~[0x211F].	Re-adjust gain according to the operation conditions.
	Encoder abnormality		If alarms occur continually after power re-input, replace the motor since there may be abnormalities in the motor.
Drive abnormality		If alarms occur continually after power re-input, replace the drive since there may be abnormalities in the drive.	
<b>AL51</b> POS following (Excessive position error)	Parameter setting abnormality	Check the setting values of [0x3000], [0x3003] and [0x3004].	Readjust the parameter according to the operation condition.
		Check the setting values of [0x300C]~[0x3013].	Set the electric gear ratio to a low value
		Check the setting values of position error range [0x301D] and position error excess time [0x301E].	Readjust the parameter according to the operation condition.
	Apparatus abnormality	Check for binding of the apparatuses.	Inspect the apparatuses.
	Drive abnormality		If alarms occur continually after power re-input, replace the drive since there may be abnormalities in the drive.
<b>AL53</b> Excessive SPD deviation	Motor cable abnormality	Check for disconnection, abnormal wiring and short circuit.	Replace the motor cable.
	Encoder cable abnormality	Check for disconnection, abnormal wiring and short circuit.	Replace the encoder cable.
	Parameter setting abnormality	Make sure that the setting values of [0x2000], [0x2001] and [0x2002] match the applied information on the motor label.	Modify the parameters so that they match the information on the motor label.
		Check the setting values of [0x300C]~[0x3013].	Set the electric gear ratio to a low value.

Alarm Code Names	Causes	Inspection Items	Measures to Take
	Apparatus abnormality	Check for binding of the apparatuses. Operation status of the limit contact sensor	Inspect the apparatuses.
	Encoder abnormality		If alarms occur continually after power re-input, replace the motor since there may be abnormalities in the motor.
	Drive abnormality		If alarms occur continually after power re-input, replace the drive since there may be abnormalities in the drive.
 Parameter checksum (Parameter error)	O/S replacement	Check the parameters with maximum setting values in the variable format.	Perform the restoration of the initial parameters. The parameter setting values are initialized after restoration. For this reason, it is necessary to set the parameters before operation.
	Drive abnormality		If alarms occur continually after power re-input, replace the drive since there may be abnormalities in the drive.
 Factory setting (Factory setting error)	Drive abnormality	Contact our service center.	If alarms occur continually after power re-input, replace the drive since there may be abnormalities in the drive.

**⚠ Caution**

- If you replace the motor and encoder cable while using an absolute encoder, or replace the battery with the servo power turned off, the encoder's multi-turn data will be lost.
- If the encoder loses multi-turn data, there is a risk of equipment malfunction and accident, so be sure to perform origin operation before driving.

## 15.6 Servo Warnings

If the drive detects an abnormality classified as a servo warning, it triggers a warning. In this case, the drive maintains its normal operation condition. After the cause of the warning is eliminated, the warning is automatically cleared. You can set the check status of each warning with warning mask configuration (0x2014). Masking servo warnings does not mean removing risks associated with warnings and the risk of damage by burn may remain. Keep this in mind when configuring the mask settings.



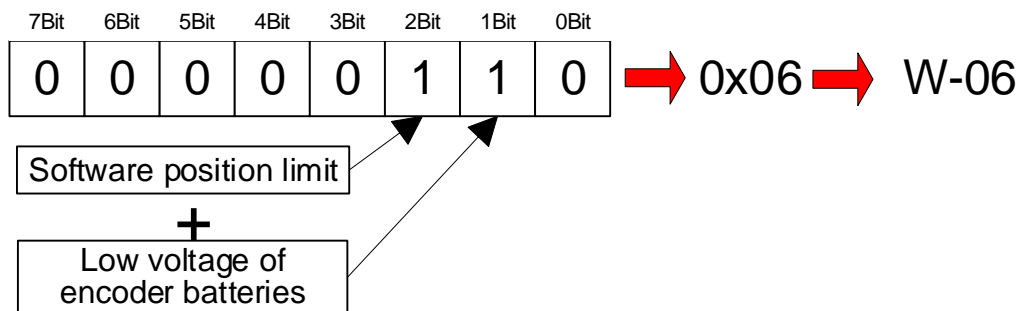

Note that warnings are displayed in the shape of 'H' on the servo display window.



Bits	Warning Codes	Warning Names
0	W01	Main power phase loss
1	W02	Low voltage of encoder battery
2	W04	Software position limit
3	W08	DB overcurrent
4	W10	Operation overload
5	W20	Abnormal combination of drive and motor
6	W40	Low voltage
7	W80	Emergency signal input
14	AL-34	Encoder phase Z loss alarm mask



If two warnings occur at the same time, each corresponding bit is set to 1. For example, when a software position limit warning is triggered, the second bit is set. Also, when an encoder battery low voltage warning is triggered, the first bit is set. The two warnings are combined into '0x06,' and you can view the alarm in the display of 'W06' on the segment window.



Warning Status (Code) Names	Causes	Inspection Items	
 PWR_FAIL (Main power phase loss)	Main power input voltage abnormality	Check if the voltage between L1 and L2 phases is AC200-230[V].	Re-inspect the main power source.
	Parameter setting abnormality	Check the setting value of [0x2006] for the main power input.	Modify [0x2006] to set an alarm instead of a warning.
	Momentary power outage	Check the setting value of [0x2007].	Lower the setting value of [0x2007] or inspect the power source.
	Drive abnormality		If alarms occur continually after power re-input, replace the drive since there may be abnormalities in the drive.
 LOW_BATT (Low voltage of encoder battery)	Parameter setting abnormality	Check the setting value of [0x2005].	To use an incremental type absolute encoder, set the value to 1 to disable alarms.
	Defective battery connection, unconnected	Check the battery connection status.	Connect the battery accurately.
	Low battery voltage	Check if the battery voltage is 3.3V or higher.	Replace the battery.
 SW_POS_LMT (Software position limit)		While the software position limit function is activated, a position command value larger than the software limit has been input.	
 OV_DB_CUR (DB overcurrent)	Motor operation by external power source	Check the operation status.	Do not operate the motor by using an external power source.
	DB resistance capacity exceeded		Perform and review the following. <ul style="list-style-type: none"> <li>• Lower the command speed of the servo motor.</li> <li>• Lower the moment of inertia of the load.</li> <li>• Lower the frequency of DB stop.</li> </ul>
	Drive abnormality		Replace the drive since the drive may have been affected.
 OV_LOAD (Operation overload)	Continuous operation with a load exceeding the rated value	Accumulated operation during constant velocity periods and pauses Check if the load is lower than 100% by the accumulated operation overload ratio value[0x2603].	Change the capacity of the motor and drive. Adjust gain.
	Motor brake abnormality	Check for opening of the motor brake during SVON.	Supply power to the motor brake.
	Parameter setting abnormality	Make sure that the setting values for motor ID [0x2000], encoder type [0x2001] and encoder format [0x2002] match the applied information on the motor label.	Modify the parameters so that they match the information on the motor label.
		Check the setting value of basic load ratio for overload detection [0x200F].	Set an appropriate value.
	Apparatus abnormality	Check for any abnormality during operation.	Inspect the apparatuses.
	Motor cable abnormality	Check for abnormal wiring and short circuit.	Replace the motor cable.

	Encoder cable abnormality	Check for abnormal wiring and short circuit.	Replace the encoder cable.
 SETUP (Setting abnormality)	Abnormal combination of drive and motor	Check if the current capacity of the applied motor exceeds that of the drive.	Lower the torque limit value or replace the motor with one that has a lower current capacity than that of the drive.
	IO setting abnormality	Check if there are repeated signal assignments in digital input signal setting~digital output signal setting.	Set the parameter appropriately for the operation conditions.
 UD_VTG (Low voltage)	Main power input voltage abnormality	Check if the main power voltage is single-phase AC170[V] or higher.	Re-inspect the main power source.
	Lowered power voltage during operation	Check if the value of [0x2605] is 280~320[V] when the main power input is normal.	Replace the drive.
		Check the wiring status of the main power.	
 EMG (Emergency signal input)	EMG contact abnormality	This represents the state of emergency pause by EMG contacts. Check the wiring and drive parameter settings (drive control input [0x211F], digital input signal 1 setting [0x2200]~digital input signal 16 setting [0x220F]).	Set the parameter appropriately for the operation conditions.
	Drive abnormality		If alarms occur continually after power re-input, replace the drive since there may be abnormalities in the drive.

## 15.7 How to Replace Encoder Battery

When AL-35 (low voltage of encoder battery (Low battery)) or W02 (low voltage of encoder battery (LOW\_BATT)) occurs, you have to replace the encoder battery.

Follow the below replacement procedures.

- (1) Maintain the control power of the drive in its on state and turn off the main power.
- (2) Separate the battery connector and remove the battery from the battery case.
- (3) Insert a newly prepared battery in the battery case and connect the battery connector. Here, use the following battery product.
  - ✓ ER6V, 3.6V 2000mAh, Lithium battery by Toshiba Battery Co., Ltd.
- (4) To release the AL-35 or W02 signal after battery replacement, turn off the control power and turn on the control power and the main power again.
- (5) Check if AL-35 and W02 have been released and operation is normal.

### <Caution>

- While replacing the battery, leave the control power on and the main power off. If you replace the battery with all powers off, the multiturn data may be lost.
- If you replace the battery after warning 02 is triggered, the warning is immediately released.
- After replacing the battery when alarm 35 has occurred, make sure to perform homing.
- Make sure that the voltage of the newly prepared battery is normal before replacement.
- Confirm “+” and “-” of the battery and connect the battery connector.
- Do not disassemble or charge the battery.
- Make sure that the poles are not short-circuited. Doing so may shorten the lifespan of the battery or generate heat.

## 15.8 Servo Overload Graph

■ Servo Drive Overload Graph (SA type, 100W or lower applied)

Load factor (%)	AL-21 duration (sec)	
	Turn	Stop
100 or lower	Infinite	Infinite
110	1696.0	1372.0
150	70.4	58.6
200	10.5	7.2
250	2.9	2.3
300	1.6	1.3

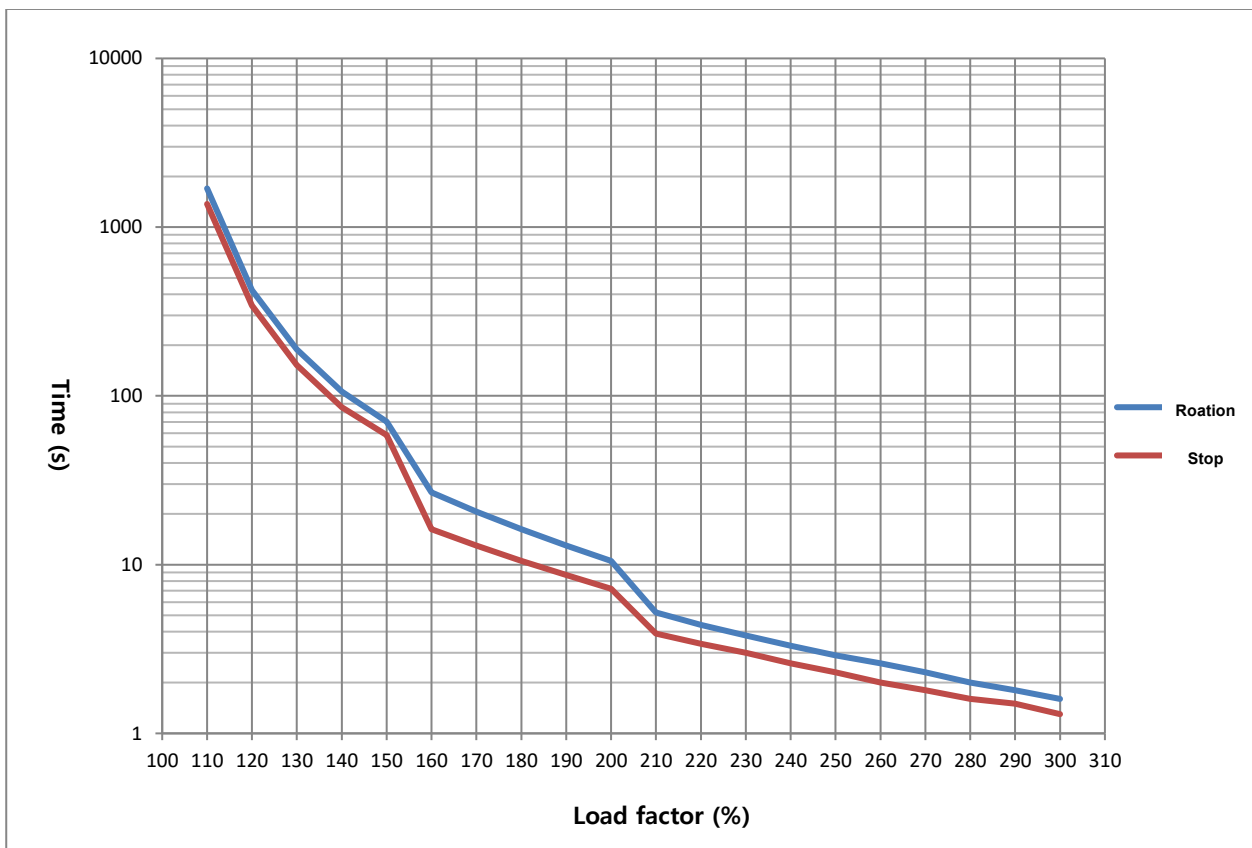

■ Servo Drive Overload Graph (400W)

Load factor (%)	AL-21 duration (sec)	
	Turn	Stop
100 or lower	Infinite	Infinite
110	55776	37935
150	1183	926
200	92	66
250	24.2	8.3
300	2.7	2.5

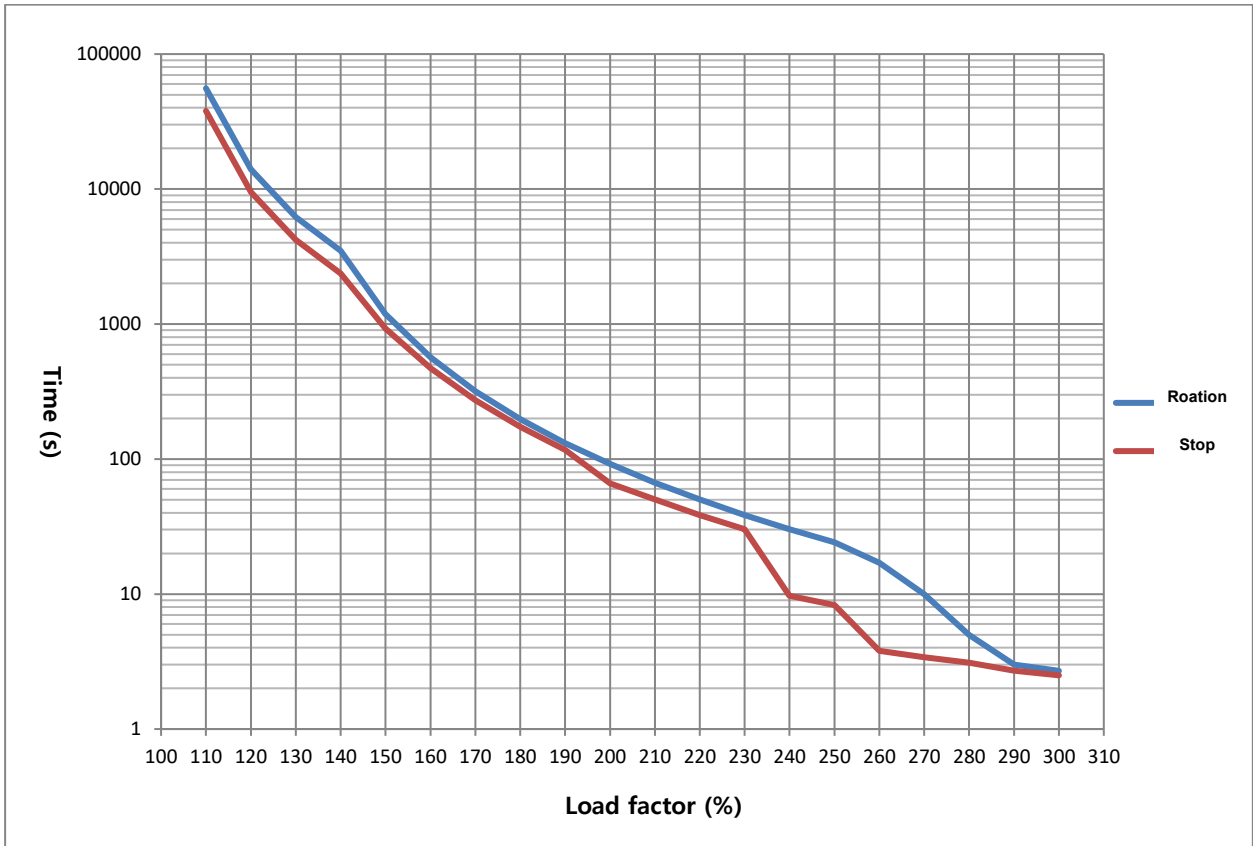

■ Servo Drive Overload Graph (750W, 1kW)

Load factor (%)	AL-21 duration (sec)	
	Turn	Stop
100 or lower	Infinite	Infinite
110	105800	37935
150	2244	926
200	201	66
250	31	8.3
300	4.6	1.7

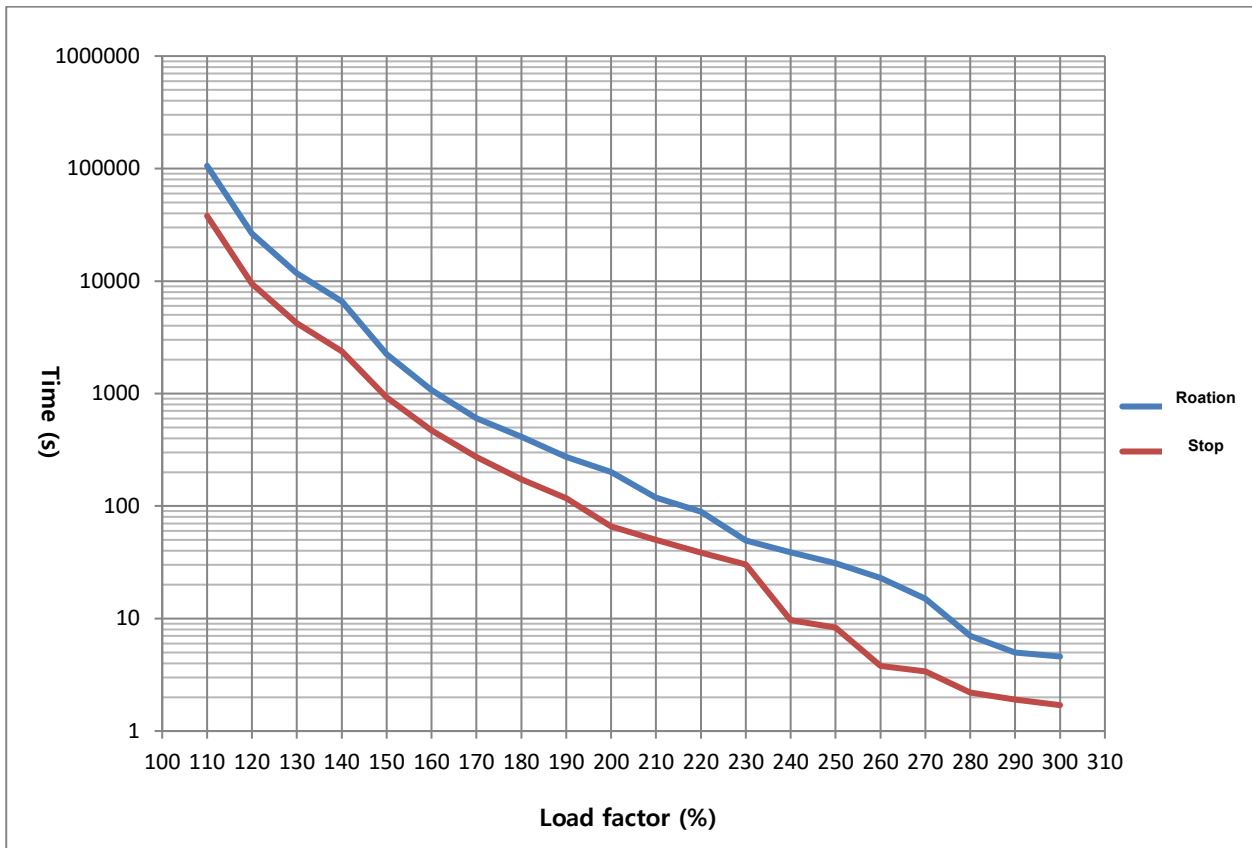

## 15.9 Servo Motor Formats and IDs (continued on the next page)

Model Names	IDs	Watts	Notes
SAR3A	1	30	
SAR5A	2	50	
SA01A	3	100	
SA015A	5	150	
SB01A	11	100	
SB02A	12	200	
SB04A	13	400	
HB02A	15	200	Hollow shaft
HB04A	16	400	Hollow shaft
SC04A	21	400	
SC06A	22	600	
SC08A	23	800	
SC10A	24	1000	
SC03D	25	300	
SC05D	26	450	
SC06D	27	550	
SC07D	28	650	
SE09A	61	900	
SE15A	62	1500	
SE22A	63	2200	
SE30A	64	3000	
SE06D	65	600	
SE11D	66	1100	
SE16D	67	1600	
SE22D	68	2200	
SE03M	69	300	
SE06M	70	600	
SE09M	71	900	
SE12M	72	1200	
SE05G	73	450	
SE09G	74	850	

Model Names	IDs	Watts	Notes
SE13G	75	1300	
SE17G	76	1700	
HE09A	77	900	Hollow shaft
HE15A	78	1500	Hollow shaft
SF30A	81	3000	
SF50A	82	5000	
SF22D	85	2200	
LF35D	190	3500	
SF55D	87	5500	
SF75D	88	7500	
SF12M	89	1200	
SF20M	90	2000	
LF30M	192	3000	
SF44M	92	4400	
SF20G	93	1800	
LF30G	191	2900	
SF44G	95	4400	
SF60G	96	6000	
SG22D	111	2200	
LG35D	193	3500	
SG55D	113	5500	
SG75D	114	7500	
SG110D	115	11000	
SG12M	121	1200	
SG20M	122	2000	
LG30M	195	3000	
SG44M	124	4400	
SG60M	125	6000	
SG20G	131	1800	
LG30G	194	2900	
SG44G	133	4400	
SG60G	134	6000	

Model Name	IDs	Watts	Notes
SG85G	135	8500	
SG110G	136	11000	
SG150G	137	15000	
FB01A	711	100	
FB02A	712	200	
FB04A	713	400	
FC04A	721	400	
FC06A	722	600	
FC08A	723	800	
FC10A	724	1000	
FC03D	725	300	
FC05D	726	500	
FC06D	727	600	
FC07D	728	700	
FE09A	761	900	
FE15A	762	1500	
FE22A	763	2200	
FE30A	764	3000	
FE06D	765	600	
FE11D	766	1100	
FE16D	767	1600	
FE22D	768	2200	
FE03M	769	300	
FE06M	770	600	
FE09M	771	900	
FE12M	772	1200	
FE05G	773	450	
FE09G	774	850	
FE13G	775	1300	
FE17G	776	1700	

Model Name	IDs	Watts	Notes
FF30A	781	3000	
FF50A	782	5000	
FF22D	785	2200	
FF35D	786	3500	
FF55D	787	5500	
FF75D	788	7500	
FF12M	789	1200	
FF20M	790	2000	
FF30M	791	3000	
FF44M	792	4000	
FF20G	793	1800	
FF30G	794	2900	
FF44G	795	4400	
FF60G	796	6000	
FF75G	804	7500	
FG22D	811	2200	
FG35D	812	3500	
FG55D	813	5500	
FG75D	814	7500	
FG12M	821	1200	
FG20M	822	2000	
FG30M	823	3000	
FG44M	824	4400	
FG20G	831	1800	
FG30G	832	2900	





Model Name	IDs	Watts	Notes
SAR3A	1	30	
SAR5A	2	50	
SA01A	3	100	
SA015A	5	150	
SB01A	11	100	
SB02A	12	200	
SB04A	13	400	
HB02A	15	200	Hollow shaft
HB04A	16	400	Hollow shaft
SC04A	21	400	
SC06A	22	600	
SC08A	23	800	
SC10A	24	1000	
SC03D	25	300	
SC05D	26	450	
SC06D	27	550	
SC07D	28	650	
SE09A	61	900	
SE15A	62	1500	
SE22A	63	2200	
SE30A	64	3000	
SE06D	65	600	
SE11D	66	1100	
SE16D	67	1600	
SE22D	68	2200	
SE03M	69	300	
SE06M	70	600	
SE09M	71	900	
SE12M	72	1200	
SE05G	73	450	
SE09G	74	850	

Model Name	IDs	Watts	Notes
SE13G	75	1300	
SE17G	76	1700	
HE09A	77	900	Hollow shaft
HE15A	78	1500	Hollow shaft
SF30A	81	3000	
SF50A	82	5000	
SF22D	85	2200	
LF35D	190	3500	
SF55D	87	5500	
SF75D	88	7500	
SF12M	89	1200	
SF20M	90	2000	
LF30M	192	3000	
SF44M	92	4400	
SF20G	93	1800	
LF30G	191	2900	
SF44G	95	4400	
SF60G	96	6000	
SG22D	111	2200	
LG35D	193	3500	
SG55D	113	5500	
SG75D	114	7500	
SG110D	115	11000	
SG12M	121	1200	
SG20M	122	2000	
LG30M	195	3000	
SG44M	124	4400	
SG60M	125	6000	
SG20G	131	1800	
LG30G	194	2900	
SG44G	133	4400	
SG60G	134	6000	

Model Names	IDs	Watts	Notes
SG85G	135	8500	
SG110G	136	11000	
SG150G	137	15000	
FB01A	711	100	
FB02A	712	200	
FB04A	713	400	
FC04A	721	400	
FC06A	722	600	
FC08A	723	800	
FC10A	724	1000	
FC03D	725	300	
FC05D	726	500	
FC06D	727	600	
FC07D	728	700	
FE09A	761	900	
FE15A	762	1500	
FE22A	763	2200	
FE30A	764	3000	
FE06D	765	600	
FE11D	766	1100	
FE16D	767	1600	
FE22D	768	2200	
FE03M	769	300	
FE06M	770	600	
FE09M	771	900	
FE12M	772	1200	
FE05G	773	450	
FE09G	774	850	
FE13G	775	1300	
FE17G	776	1700	

Model Names	IDs	Watts	Notes
FF30A	781	3000	
FF50A	782	5000	
FF22D	785	2200	
FF35D	786	3500	
FF55D	787	5500	
FF75D	788	7500	
FF12M	789	1200	
FF20M	790	2000	
FF30M	791	3000	
FF44M	792	4000	
FF20G	793	1800	
FF30G	794	2900	
FF44G	795	4400	
FF60G	796	6000	
FF75G	804	7500	
FG22D	811	2200	
FG35D	812	3500	
FG55D	813	5500	
FG75D	814	7500	
FG12M	821	1200	
FG20M	822	2000	
FG30M	823	3000	
FG44M	824	4400	
FG20G	831	1800	
FG30G	832	2900	

Model Names	IDs	Watts	Notes
DB03D	601	63	
DB06D	602	126	
DB09D	603	188	
DC06D	611	126	
DC12D	612	251	
DC18D	613	377	
DD12D	621	251	
DD22D	622	461	
DD34D	623	712	
DE40D	632	838	
DE60D	633	1257	
DFA1G	641	1728	
DFA6G	642	2513	

Model Names	IDs	Watts	Notes
FAL05A	702	50	
FAL01A	703	100	
FAL15A	704	150	
FBL01A	714	100	
FBL02A	715	200	
FBL04A	716	400	
FCL04A	729	400	
FCL06A	730	600	
FCL08A	731	750	
FCL10A	732	1000	
FCL03D	733	300	
FCL05D	734	450	
FCL06D	735	550	
FCL07D	736	650	

# 16. Communication Protocol

## 16.1 Overview and Communication Specifications

### 16.1.1 Overview

L7C drive is for RS-422 serial communication. By connecting it an upper level controller such as HMI, PLC and PC, you can use functions such as test-driving, gain tuning, parameter change and index operation.

You can also operate or control communication of up to 99 shafts by connecting multiple L7C drives via the multi-drop method.

#### ■ Serial Communication Access Through RS-422

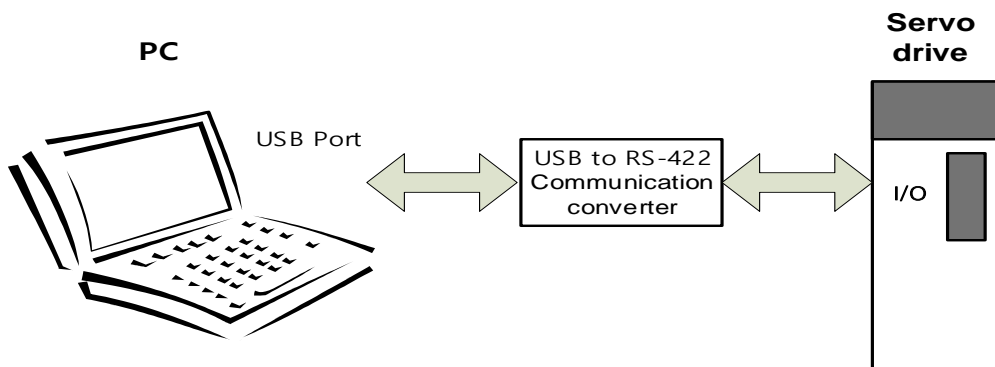

#### ■ Multi-drop Access through RS-422 (Up to 99 devices)

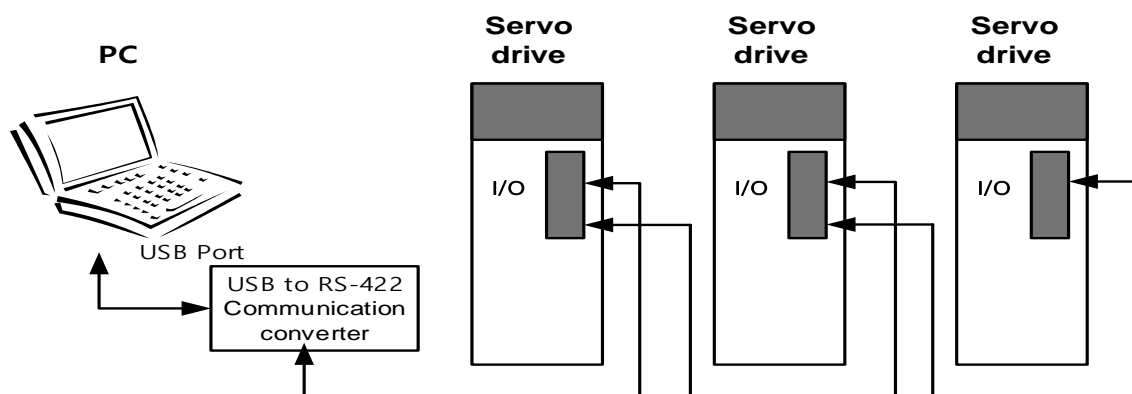

**Note 1)** When using a PC as the upper level controller, you have to use the USB-to-RS-422 communication converter.

**Note 2)** Connect the cable shields to the connector case.

**Note 3)** Do not use APC-VSCN1T or APC-VPCN1T during communication wiring. Communication may be disconnected due to disconnection in cable shields.

## 16.1.2 Communication Specifications and Cable Access Rate

### ■ Communication Specifications

Items		Specifications
Communication Standard		ANSI/TIA/EIA-422 Standard
Communication Protocol		MODBUS-RTU
Data Type	Data bit	8bit
	Stop bit	1bit
	Parity	None
Synchronization		Asynchronous
Transmission Rate		9600/19200/38400/57600 [bps] Communication speed setting possible in [0x3002]
Transmission Distance		Up to 200[m]
Current Consumption		100[mA] or lower

### ■ Connector Pin Connection for RS-422

Pin Numbers	Pin Functions
6	RXD+
7	RXD-
2	TXD+
3	TXD-
28	Terminating resistance connection

For RS-422 communication, you must connect signal lines to the CN1 connector. For stability of the product, it is recommended to use STP cables and connectors and connect TXD+ and TXD- as well as RXD+ and RXD- as twisted pairs. Connect 7 and 28 for the terminating resistance. A resistance of 120Ω is charged inside the driver.

#### <Caution>

- Do not use APC-VSCN1T or APC-VPCN1T during communication wiring. Communication may be disconnected due to disconnection in cable shields. Also, build the structure of a single connector holding individual lines of RS-422 communication cables and input/output cables. Make sure to use shielded twisted cables (Twisted Pair Wire) as the RS-422 communication cables.
- To frequently write data, make sure to set the value of Individual Parameter Save[0X240E] to 0. Frequent EEPROM writing shortens the lifespan of the product.

## 16.2 Basic Structure of Communication Protocol

In principle, communication of L7C drive complies with the MODBUS-RTU protocol. For information about items not covered in this manual, refer to the following standard. (Related standard: Modbus Application Protocol Specification 1.1b, 2006.12.28)

Also, the concepts of sending (Tx) and receiving (Rx) are for the Host in this manual.

### 16.2.1 Sending/Receiving Packet Structure

The maximum sending/receiving packet length of the MODBUS-RTU protocol is 256 bytes. Make sure that the total length of the sending/receiving packet does not exceed 256 bytes.

The MODBUS-RTU communication mode requires space of at least 3.5 char between the ends of packets to distinguish the packets as shown in the following image.

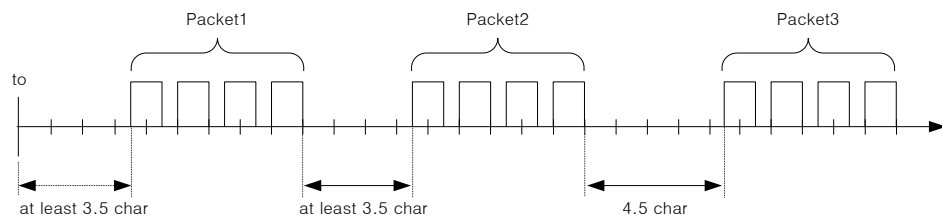

#### ■ Sending Packet Structure

	Additional Address	Function Code	Data			Error Check	
Bytes	0	1	2	.	.	n-1	n
Details	Node ID	Function	Data	.	.	CRC (MSB)	CRC (LSB)

#### ■ Receiving Packet Structure

##### [Normal Response]

	Additional Address	Function Code	Data			Error Check	
Bytes	0	1	2	.	.	n-1	n
Details	Node ID	Function	Data	.	.	CRC (MSB)	CRC (LSB)

##### [Abnormal Response]

	Additional Address	Function Code	Data	Error Check	
Bytes	0	1	2	3	4
Details	Node ID	Function+0x80	Exception code	CRC (MSB)	CRC (LSB)

## ■ Protocol Packet Code

- Node ID

It shows the identification number of the servo drive for sending and receiving.

You can set the identification number of the servo drive in parameter [0x2003]. Turn on/off the power of the drive after setting.

- Function Code

The following are the Modbus-RTU standard function codes supported by L7C drive.

Category	Comm and Codes	Descriptions	Purpose	
			Read	Write
PUBLIC Function Codes	0x01	Read Coils	○	
	0x02	Read Discrete Inputs	○	
	0x03	Read Holding Registers	○	
	0x04	Read Input Register	○	
	0x05	Write Single Coil		○
	0x06	Write Single Register		○
	0x0F	Write Multiple Coils		○
	0x10	Write Multiple Registers		○

- Data

**[Sending]:** For a read register command, it is necessary to set the Modbus address and numbers of registers and bytes. For a write register, it is necessary to set the Modbus address, number of bytes and setting value.

**[Receiving]:** For a normal response of a read register, the node ID and function code in receiving have the same number as in sending. Data are received with register values according to the register order during sending.

For the write single register command, the transmitted data are received without change. For the write multi registers command, the start address of the register for which to write data using the command as well as the number of registers are received.

An abnormal response consists of node ID, error code and exception code. All abnormal responses have the same packet structure regardless of their function codes.

- CRC

You can input the 16 bit CRC value. 1 byte each of MSB and LSB is sent.

- Exception Code

The followings are the exception codes for all abnormal responses of all function codes supported in L7C drive.

Exception Codes	Descriptions
0x01	Unsupported function code
0x02	Invalid register address
0x03	Invalid data
0x04	Device malfunction, parameter setting value abnormality <small>Note 1)</small>



Exception Codes	Descriptions
0x05	Data unprepared
0x06	Parameter locked

Note1) If the setting range of the parameter is the same as that of the data type and a value out of the range is input, no response is made using the exception code, but the maximum and minimum values are set.

## 16.2.2 Protocol Command Codes

### (1) Read Coils (0x01)

It reads individual bit outputs as well as continual bit output block values.

#### ■ Request

Function Code	1Byte	0x01
Starting Address	2Byte	0x0000 to 0xFFFF
Quantity of Coils	2Bytes	1 to 2000 (0x7D0)

#### ■ Request OK

Function Code	1Byte	0x01
Byte Count	1Byte	N*
Coil Status	n Bytes	n= N or N+1

\*N= Quantity of Outputs/8

#### ■ Response not OK

Error Code	1Byte	0x81
Exception Code	1Byte	0x01~0x04

The command code Read Coils can read the status of contacts that correspond to drive status input 1, 2 and drive status output 1, 2. The following are the addresses that correspond to drive status input 1, 2 and drive status output 1, 2.

#### ■ Drive Status Input 1, 2 Communication Addresses

Communication Address		Output Contacts	Accessability	Communication Address		Output Contacts	Accessability
Decimal Numbers	Hexadecimal Numbers			Decimal Numbers	Hexadecimal Numbers		
0	0x0000	POT	RW	16	0x0010	START	RW
1	0x0001	NOT	RW	17	0x0011	PAUSE	RW
2	0x0002	HOME	RW	18	0x0012	REGT	RW
3	0x0003	STOP	RW	19	0x0013	HSTART	RW
4	0x0004	PCON	RW	20	0x0014	ISEL0	RW
5	0x0005	GAIN2	RW	21	0x0015	ISEL1	RW
6	0x0006	P_CL	RW	22	0x0016	ISEL2	RW
7	0x0007	N_CL	RW	23	0x0017	ISEL3	RW
8	0x0008	MODE	RW	24	0x0018	ISEL4	RW
9	0x0009	Reserved	RW	25	0x0019	ISEL5	RW
10	0x000A	EMG	RW	26	0x001A	ABSRQ	RW

11	0x000B	A_RST	RW	27	0x001B	JSTART	RW
12	0x000C	SV_ON	RW	28	0x001C	JDIR	RW
13	0x000D	SPD1/LVSF 1	RW	29	0x001D	PCLEAR	RW
14	0x000E	SPD2/LVSF 2	RW	30	0x001E	AOVR	RW
15	0x000F	SPD3	RW	31	0x001F	Reserved	RW

### ■ Drive Status Output 1, 2 Communication Addresses

Communication Address		Output Contacts	Accessability	Communication Address		Output Contacts	Accessability
Decimal Numbers	Hexadecimal Numbers			Decimal Numbers	Hexadecimal Numbers		
32	0x0020	BRAKE	RO	48	0x0030	ORG	RO
33	0x0021	ALARM	RO	49	0x0031	EOS	RO
34	0x0022	READY	RO	50	0x0032	IOOUT0	RO
35	0x0023	ZSPD	RO	51	0x0033	IOOUT1	RO
36	0x0024	INPOS1	RO	52	0x0034	IOOUT2	RO
37	0x0025	TLMT	RO	53	0x0035	IOOUT3	RO
38	0x0026	VLMT	RO	54	0x0036	IOOUT4	RO
39	0x0027	INSPD	RO	55	0x0037	IOOUT5	RO
40	0x0028	WARN	RO	56	0x0038	Reserved	RO
41	0x0029	TGON	RO	57	0x0039	Reserved	RO
42	0x002A	Reserved	RO	58	0x003A	Reserved	RO
43	0x002B	Reserved	RO	59	0x003B	Reserved	RO
44	0x002C	Reserved	RO	60	0x003C	Reserved	RO
45	0x002D	Reserved	RO	61	0x003D	Reserved	RO
46	0x002E	Reserved	RO	62	0x003E	Reserved	RO
47	0x002F	Reserved	RO	63	0x003F	Reserved	RO

ex) Reading brake output contact status

### ■ Request

Node ID	Function	Starting Address Hi	Starting Address Lo	Quantity of Outputs Hi	Quantity of Outputs Lo	CRC Hi	CRC Lo
0x01	0x01	0x00	0x20	0x00	0x01	0xFC	0x00

### ■ Request OK

Node ID	Function	Byte Count	Outputs Status	CRC Hi	CRC Lo
0x01	0x01	0x01	0x01	0x90	0x48

- The BRAKE output contact status is High (1).

### ■ Response not OK

Node ID	Error Code	Exception Code	CRC Hi	CRC Lo
0x01	0x81	0x01~0x04	-	-

You can write the start address setting for protocol use in Start Address. Keep in mind while writing that there are upper and lower parts. Quantity of Output is where you can set how many status of input/output address to request from the start address. If you input 01, you can receive 1 status value. If you input 03, you can receive 3 consecutive status values.

The following is an example of protocols for sending and receiving status input/output during servo off.

Function	Transmission	Receipt	Status
POT	[01][01][00][00][00][01][FD][CA]	[01][01][01][00][51][88]	OFF
NOT	[01][01][00][01][00][01][AC][0A]	[01][01][01][00][51][88]	OFF
HOME	[01][01][00][02][00][01][5C][0A]	[01][01][01][00][51][88]	OFF
STOP	[01][01][00][03][00][01][0D][CA]	[01][01][01][00][51][88]	OFF
PCON	[01][01][00][04][00][01][BC][0B]	[01][01][01][00][51][88]	OFF
GAIN2	[01][01][00][05][00][01][ED][CB]	[01][01][01][00][51][88]	OFF
P_CL	[01][01][00][06][00][01][1D][CB]	[01][01][01][00][51][88]	OFF
N_CL	[01][01][00][07][00][01][4C][0B]	[01][01][01][00][51][88]	OFF
MODE	[01][01][00][08][00][01][7C][08]	[01][01][01][00][51][88]	OFF
EMG	[01][01][00][0A][00][01][DD][C8]	[01][01][01][00][51][88]	OFF
A_RST	[01][01][00][0B][00][01][8C][08]	[01][01][01][00][51][88]	OFF
SV_ON	[01][01][00][0C][00][01][3D][C9]	[01][01][01][00][51][88]	OFF
SPD1/LVSF1	[01][01][00][0D][00][01][6C][09]	[01][01][01][00][51][88]	OFF
SPD2/LVSF2	[01][01][00][0E][00][01][9C][09]	[01][01][01][00][51][88]	OFF
SPD3	[01][01][00][0F][00][01][CD][C9]	[01][01][01][00][51][88]	OFF
START	[01][01][00][10][00][01][FC][0F]	[01][01][01][00][51][88]	OFF
PAUSE	[01][01][00][11][00][01][AD][CF]	[01][01][01][00][51][88]	OFF
REGT	[01][01][00][12][00][01][5D][CF]	[01][01][01][00][51][88]	OFF
HSTART	[01][01][00][13][00][01][0C][0F]	[01][01][01][00][51][88]	OFF
ISEL0	[01][01][00][14][00][01][BD][CE]	[01][01][01][00][51][88]	OFF
ISEL1	[01][01][00][15][00][01][EC][0E]	[01][01][01][00][51][88]	OFF
ISEL2	[01][01][00][16][00][01][1C][0E]	[01][01][01][00][51][88]	OFF
ISEL3	[01][01][00][17][00][01][4D][CE]	[01][01][01][00][51][88]	OFF
ISEL4	[01][01][00][18][00][01][7D][CD]	[01][01][01][00][51][88]	OFF
ISEL5	[01][01][00][19][00][01][2C][0D]	[01][01][01][00][51][88]	OFF
ABSRQ	[01][01][00][1A][00][01][DC][0D]	[01][01][01][00][51][88]	OFF
JSTART	[01][01][00][1B][00][01][8D][CD]	[01][01][01][00][51][88]	OFF
JDIR	[01][01][00][1C][00][01][3C][0C]	[01][01][01][00][51][88]	OFF
PCLEAR	[01][01][00][1D][00][01][6D][CC]	[01][01][01][00][51][88]	OFF
AOVR	[01][01][00][1E][00][01][9D][CC]	[01][01][01][00][51][88]	OFF
BRAKE	[01][01][00][20][00][01][FC][00]	[01][01][01][01][90][48]	ON
ALARM	[01][01][00][21][00][01][AD][C0]	[01][01][01][00][51][88]	OFF
READY	[01][01][00][22][00][01][5D][C0]	[01][01][01][01][90][48]	ON
ZSPD	[01][01][00][23][00][01][0C][00]	[01][01][01][01][90][48]	ON
INPOS1	[01][01][00][24][00][01][BD][C1]	[01][01][01][01][90][48]	ON
TLMT	[01][01][00][25][00][01][EC][01]	[01][01][01][00][51][88]	OFF
VLMT	[01][01][00][26][00][01][1C][01]	[01][01][01][00][51][88]	OFF
INSPD	[01][01][00][27][00][01][4D][C1]	[01][01][01][01][90][48]	ON
WARN	[01][01][00][28][00][01][7D][C2]	[01][01][01][00][51][88]	OFF
TGON	[01][01][00][29][00][01][2C][02]	[01][01][01][00][51][88]	OFF
ORG	[01][01][00][30][00][01][FD][C5]	[01][01][01][00][51][88]	OFF
EOS	[01][01][00][31][00][01][AC][05]	[01][01][01][01][90][48]	ON
IOUT0	[01][01][00][32][00][01][5C][05]	[01][01][01][00][51][88]	OFF
IOUT1	[01][01][00][33][00][01][0D][C5]	[01][01][01][00][51][88]	OFF
IOUT2	[01][01][00][34][00][01][BC][04]	[01][01][01][00][51][88]	OFF
IOUT3	[01][01][00][35][00][01][ED][C4]	[01][01][01][00][51][88]	OFF
IOUT4	[01][01][00][36][00][01][1D][C4]	[01][01][01][00][51][88]	OFF
IOUT5	[01][01][00][37][00][01][4C][04]	[01][01][01][00][51][88]	OFF

The following table shows an example of 2 status values being received from the start address of 0x0020 during servo off.

Function	Transmission	Receipt
BRAKE~ALARM	[01][01][00][20][00][02][BC][01]	[01][01][01][01][90][48]

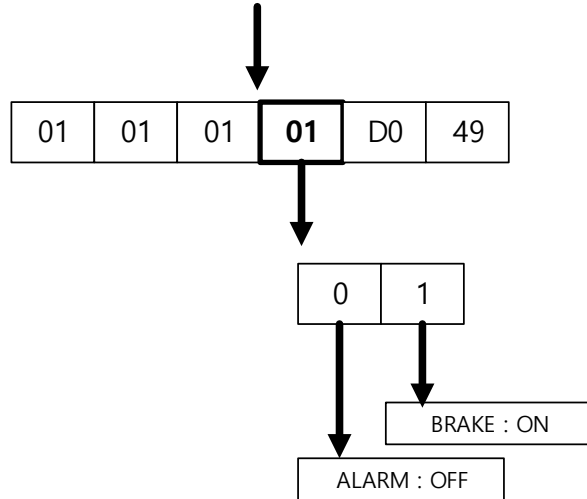

If you set Quantity of Output to 02 for the start address of 0x0020 in the sending protocol, a total of 2 input status values from 0020~0021 are requested. Since Outputs Status Bits of the received protocol is 01, BRAKE is ON and ALARM is OFF.

Function	Transmission	Receipt
BRAKE~READY	[01][01][00][20][00][03][7D][C1]	[01][01][01][05][91][8B]

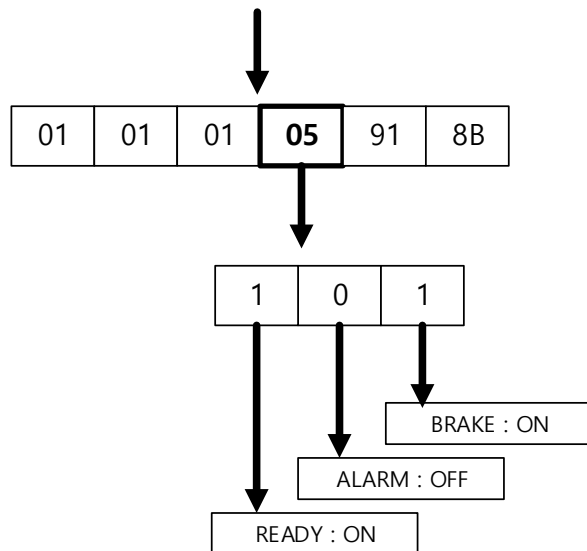

If you set Quantity of Output to 03, you can receive the status values from 0020~0022.

Function	Transmission	Receipt
BRAKE~ZSPD	[01][01][00][20][00][04][3C][03]	[01][01][01][0D][90][4D]

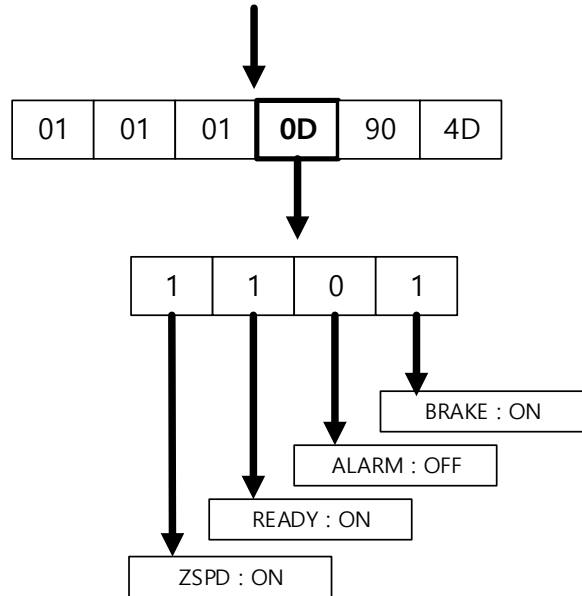

If you set Quantity of Output to 04, you can receive the status values from 0020~0023.

Function	Transmission	Receipt
BRAKE~INPOS1	[01][01][00][20][00][05][FD][C3]	[01][01][01][1D][91][81]

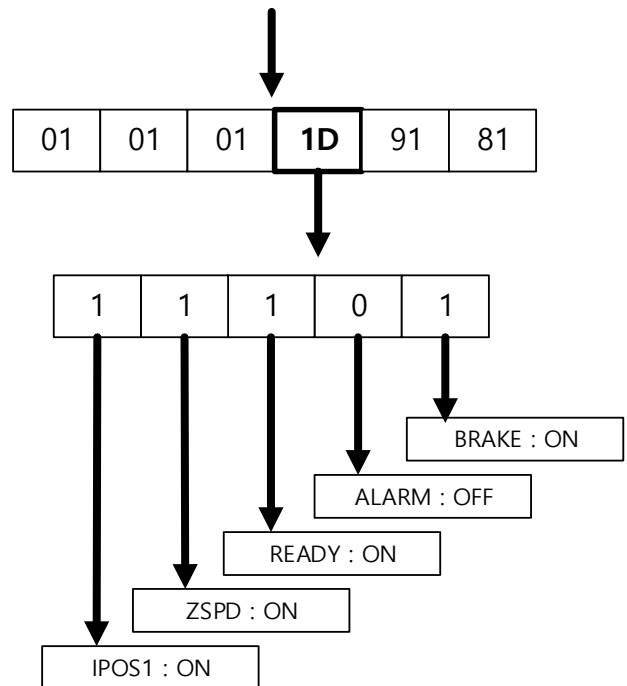

If you set Quantity of Output to 05, you can receive the status values from 0020~0024.

**(2) Read Discrete Inputs (0x02)**

It reads individual bit outputs as well as continual bit input block values.

■ **Request**

Function Code	1Byte	0x02
Starting Address	2Byte	0x0000 to 0xFFFF
Quantity of Inputs	2Bytes	1 to 2000 (0x7D0)

■ **Request OK**

Function Code	1Byte	0x02
Starting Address	1Byte	N*
Input Status	N* x 1Byte	

\*N= Quantity of Inputs/8

■ **Response not OK**

Error Code	1Byte	0x82
Exception Code	1Byte	0x01~0x04

The command code Read Discrete Inputs can read the status of contacts that correspond to drive status input 1, 2 and drive status output 1, 2. The following are the addresses that correspond to drive status input 1, 2 and drive status output 1, 2.



### ■ Drive Status Input 1, 2 Communication Addresses

Communication Address		Output Contacts	Accessibility	Communication Address		Output Contacts	Accessibility
Decimal Numbers	Hexadecimal Numbers			Decimal Numbers	Hexadecimal Numbers		
0	0x0000	POT	RW	16	0x0010	START	RW
1	0x0001	NOT	RW	17	0x0011	PAUSE	RW
2	0x0002	HOME	RW	18	0x0012	REGT	RW
3	0x0003	STOP	RW	19	0x0013	HSTART	RW
4	0x0004	PCON	RW	20	0x0014	ISEL0	RW
5	0x0005	GAIN2	RW	21	0x0015	ISEL1	RW
6	0x0006	P_CL	RW	22	0x0016	ISEL2	RW
7	0x0007	N_CL	RW	23	0x0017	ISEL3	RW
8	0x0008	MODE	RW	24	0x0018	ISEL4	RW
9	0x0009	Reserved	RW	25	0x0019	ISEL5	RW
10	0x000A	EMG	RW	26	0x001A	ABSRQ	RW
11	0x000B	A_RST	RW	27	0x001B	JSTART	RW
12	0x000C	SV_ON	RW	28	0x001C	JDIR	RW
13	0x000D	SPD1/LVSF 1	RW	29	0x001D	PCLEAR	RW
14	0x000E	SPD2/LVSF 2	RW	30	0x001E	AOVR	RW
15	0x000F	SPD3	RW	31	0x001F	Reserved	RW

### ■ Drive Status Output 1, 2 Communication Addresses

Communication Address		Output Contacts	Accessability	Communication Address		Output Contacts	Accessability
Decimal Numbers	Hexadecimal Numbers			Decimal Numbers	Hexadecimal Numbers		
32	0x0020	BRAKE	RO	48	0x0030	ORG	RO
33	0x0021	ALARM	RO	49	0x0031	EOS	RO
34	0x0022	READY	RO	50	0x0032	IOOUT0	RO
35	0x0023	ZSPD	RO	51	0x0033	IOOUT1	RO
36	0x0024	INPOS1	RO	52	0x0034	IOOUT2	RO
37	0x0025	TLMT	RO	53	0x0035	IOOUT3	RO
38	0x0026	VLMT	RO	54	0x0036	IOOUT4	RO
39	0x0027	INSPD	RO	55	0x0037	IOOUT5	RO
40	0x0028	WARN	RO	56	0x0038	Reserved	RO
41	0x0029	TGON	RO	57	0x0039	Reserved	RO
42	0x002A	Reserved	RO	58	0x003A	Reserved	RO
43	0x002B	Reserved	RO	59	0x003B	Reserved	RO
44	0x002C	Reserved	RO	60	0x003C	Reserved	RO
45	0x002D	Reserved	RO	61	0x003D	Reserved	RO
46	0x002E	Reserved	RO	62	0x003E	Reserved	RO
47	0x002F	Reserved	RO	63	0x003F	Reserved	RO

ex) Reading POT input contact status

### ■ Request

Node ID	Function	Starting Address Hi	Starting Address Lo	Quantity of Inputs Hi	Quantity of Inputs Lo	CRC Hi	CRC Lo
0x01	0x02	0x00	0x00	0x00	0x01	0XB9	0xCA

### ■ Request OK

Node ID	Function	Byte Count	Input Status	CRC Hi	CRC Lo
0x01	0x02	0x01	0x00	0xA1	0x88

- The POT input contact status is Low (0).

### ■ Response not OK

Node ID	Error Code	Exception Code	CRC Hi	CRC Lo
0x01	0x82	0x01~0x04	-	-

## 1) Example of Digital I/O Status Value Protocol

Function	Transmission	Receipt	Status
POT	[01][02][00][00][00][01][B9][CA]	[01][02][01][00][A1][88]	OFF
NOT	[01][02][00][01][00][01][E8][0A]	[01][02][01][00][A1][88]	OFF
HOME	[01][02][00][02][00][01][18][0A]	[01][02][01][00][A1][88]	OFF
STOP	[01][02][00][03][00][01][49][CA]	[01][02][01][00][A1][88]	OFF
PCON	[01][02][00][04][00][01][F8][0B]	[01][02][01][00][A1][88]	OFF
GAIN2	[01][02][00][05][00][01][A9][CB]	[01][02][01][00][A1][88]	OFF
P_CL	[01][02][00][06][00][01][59][CB]	[01][02][01][00][A1][88]	OFF
N_CL	[01][02][00][07][00][01][08][0B]	[01][02][01][00][A1][88]	OFF
MODE	[01][02][00][08][00][01][38][08]	[01][02][01][00][A1][88]	OFF
EMG	[01][02][00][0A][00][01][99][C8]	[01][02][01][00][A1][88]	OFF
A_RST	[01][02][00][0B][00][01][C8][08]	[01][02][01][00][A1][88]	OFF
SV_ON	[01][02][00][0C][00][01][79][C9]	[01][02][01][00][A1][88]	OFF
SPD1/LVSF1	[01][02][00][0D][00][01][28][09]	[01][02][01][00][A1][88]	OFF
SPD2/LVSF2	[01][02][00][0E][00][01][D8][09]	[01][02][01][00][A1][88]	OFF
SPD3	[01][02][00][0F][00][01][89][C9]	[01][02][01][00][A1][88]	OFF
START	[01][02][00][10][00][01][B8][0F]	[01][02][01][00][A1][88]	OFF
PAUSE	[01][02][00][11][00][01][E9][CF]	[01][02][01][00][A1][88]	OFF
REGT	[01][02][00][12][00][01][19][CF]	[01][02][01][00][A1][88]	OFF
HSTART	[01][02][00][13][00][01][48][0F]	[01][02][01][00][A1][88]	OFF
ISEL0	[01][02][00][14][00][01][F9][CE]	[01][02][01][00][A1][88]	OFF
ISEL1	[01][02][00][15][00][01][A8][0E]	[01][02][01][00][A1][88]	OFF
ISEL2	[01][02][00][16][00][01][58][0E]	[01][02][01][00][A1][88]	OFF
ISEL3	[01][02][00][17][00][01][09][CE]	[01][02][01][00][A1][88]	OFF
ISEL4	[01][02][00][18][00][01][39][CD]	[01][02][01][00][A1][88]	OFF
ISEL5	[01][02][00][19][00][01][68][0D]	[01][02][01][00][A1][88]	OFF
ABSRQ	[01][02][00][1A][00][01][98][0D]	[01][02][01][00][A1][88]	OFF
JSTART	[01][02][00][1B][00][01][C9][CD]	[01][02][01][00][A1][88]	OFF
JDIR	[01][02][00][1C][00][01][78][0C]	[01][02][01][00][A1][88]	OFF
PCLEAR	[01][02][00][1D][00][01][29][CC]	[01][02][01][00][A1][88]	OFF
AOVR	[01][02][00][1E][00][01][D9][CC]	[01][02][01][00][A1][88]	OFF
BRAKE	[01][02][00][20][00][01][B8][00]	[01][02][01][01][60][48]	ON
ALARM	[01][02][00][21][00][01][E9][C0]	[01][02][01][00][A1][88]	OFF
READY	[01][02][00][22][00][01][19][C0]	[01][02][01][01][60][48]	ON
ZSPD	[01][02][00][23][00][01][48][00]	[01][02][01][01][60][48]	ON
INPOS1	[01][02][00][24][00][01][F9][C1]	[01][02][01][01][60][48]	ON
TLMT	[01][02][00][25][00][01][A8][01]	[01][02][01][00][A1][88]	OFF
VLMT	[01][02][00][26][00][01][58][01]	[01][02][01][00][A1][88]	OFF
INSPD	[01][02][00][27][00][01][09][C1]	[01][02][01][01][60][48]	ON
WARN	[01][02][00][28][00][01][39][C2]	[01][02][01][00][A1][88]	OFF
TGON	[01][02][00][29][00][01][68][02]	[01][02][01][00][A1][88]	OFF
ORG	[01][02][00][30][00][01][B9][C5]	[01][02][01][00][A1][88]	OFF
EOS	[01][02][00][31][00][01][E8][05]	[01][02][01][01][60][48]	ON
IOUT0	[01][02][00][32][00][01][18][05]	[01][02][01][00][A1][88]	OFF
IOUT1	[01][02][00][33][00][01][49][C5]	[01][02][01][00][A1][88]	OFF
IOUT2	[01][02][00][34][00][01][F8][04]	[01][02][01][00][A1][88]	OFF
IOUT3	[01][02][00][35][00][01][A9][C4]	[01][02][01][00][A1][88]	OFF
IOUT4	[01][02][00][36][00][01][59][C4]	[01][02][01][00][A1][88]	OFF
IOUT5	[01][02][00][37][00][01][08][04]	[01][02][01][00][A1][88]	OFF

The following is an example of protocol for a request of 2 status values from the start address 0x0020.

2) Example of parameter reading for 0x0020~0x0021

Function	Transmission	Receipt
BRAKE~ALARM	[01][02][00][20][00][02][F8][01]	[01][02][01][01][60][48]

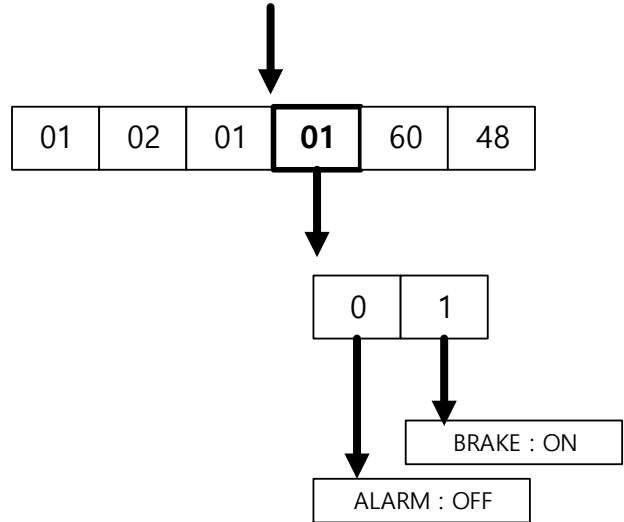

2) Example of parameter reading for 0x0020~0x0022

Function	Transmission	Receipt
BRAKE~READY	[01][02][00][20][00][03][39][C1]	[01][02][01][05][61][8B]

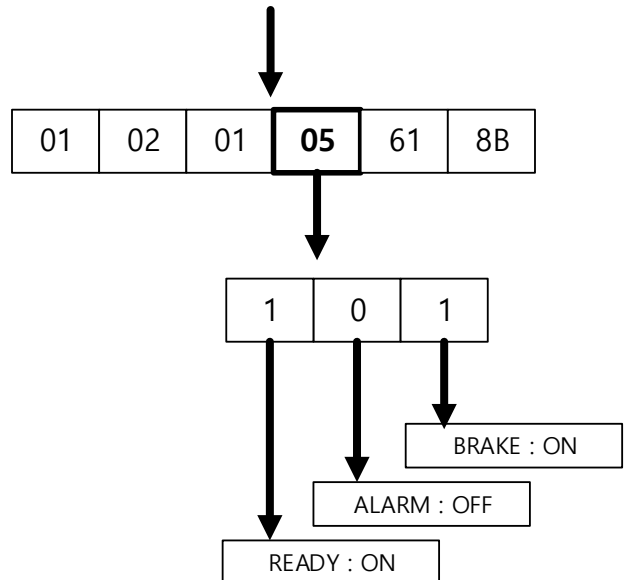

3) Example of parameter reading for 0x0020~0x0023

Function	Transmission	Receipt
BRAKE~ZSPD	[01][02][00][20][00][04][78][03]	[01][02][01][0D][60][4D]

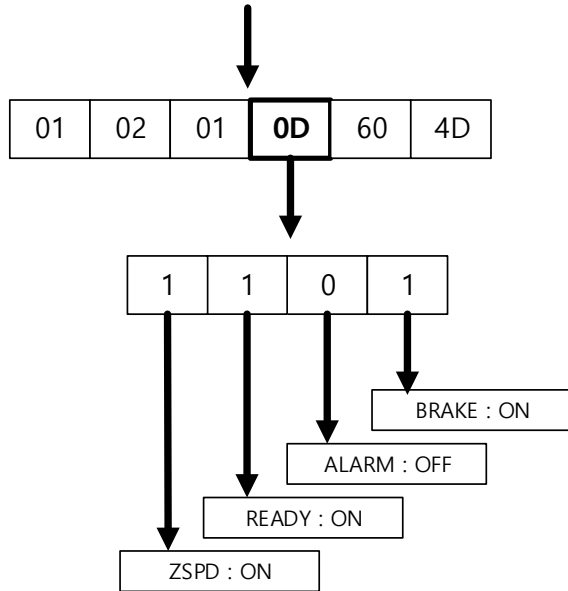

4) Example of parameter reading for 0x0020~0x0024

Function	Transmission	Receipt
BRAKE~INPOS1	[01][02][00][20][00][05][B9][C3]	[01][02][01][1D][61][81]

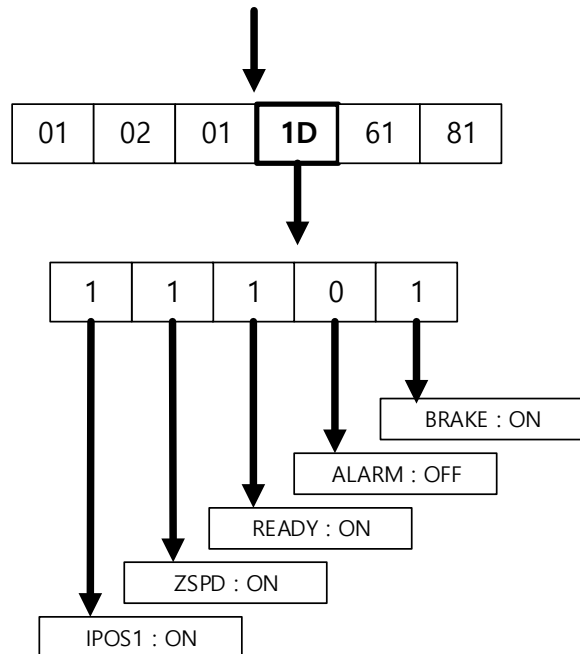

**(3) Read Holding Register (0x03)**

It reads single registers (16-bit data) and continuous register block (16 bit data) values.

**Request**

Function Code	1Byte	0x03
Starting Address	2Byte	0x0000 to 0xFFFF
Quantity of Registers	2Bytes	1 to 125 (0x7D)

**Request OK**

Function Code	1Byte	0x03
Starting Address	1Byte	2 x N*
Quantity of Registers	N* x 2Bytes	

\*N= Quantity of Registers

**Response not OK**

Error Code	1Byte	0x83
Exception Code	1Byte	0x01~0x06

ex 1) when reading only the parameter for the current velocity (Address: 0x2600)

**Request**

Node ID	Function	Starting Address Hi	Starting Address Lo	Quantity of Register Hi	Quantity of Register Lo	CRC Hi	CRC Lo
0x01	0x03	0x26	0x00	0x00	0x01	0x8F	0x42

**Request OK**

Node ID	Function	Byte Count	Register Value Hi	Register Value Lo	CRC Hi	CRC Lo
0x01	0x03	0x02	0x00	0x00	0xB8	0x44

- The current velocity value is 0 (or 0x0000).

**Response not OK**

Node ID	Error Code	Exception Code	CRC Hi	CRC Lo
0x01	0x83	0x01~0x06	-	-

ex 2) when reading several parameters including motor ID (Address: 0x2000), encoder type (Address: 0x2000) encoder pulse count per revolution (Address: 0x2002~0x2003 )

**Request**

Node ID	Function	Starting Address Hi	Starting Address Lo	Quantity of Register Hi	Quantity of Register Lo	CRC Hi	CRC Lo
0x01	0x03	0x20	0x00	0x00	0x04	0x4F	0XC9

**Request OK**

Node ID	Function	Byte Count	Register Value Hi	Register Value Lo	Register Value Hi	Register Value Lo	Register Value Hi	Register Value Lo
0x01	0x03	0x08	0x00	0x0D	0x00	0x02	0x00	0x00

Register Value Hi	Register Value Lo	CRC Hi	CRC Lo
0x00	0x08	0x31	0X11

- The motor ID (Address: 0x2000) value is 13 (or 0x000D) and the encoder type (Address: 0x2001) value is 2 (or 0x0002). Since the encoder pulse count per revolution (Address: 0x2002~0x2003) is 32-bit data, the data that has been read must be swapped. The currently displayed value is 524288 (or 0x00080000).

#### ■ Response not OK

Node ID	Error Code	Exception Code	CRC Hi	CRC Lo
0x01	0x83	0x01~0x06	-	-

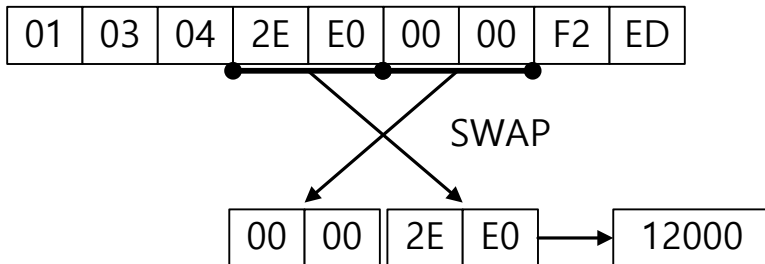

Be cautious with parsing for a 2 byte register since 1 byte for each of the upper and lower parts is swapped. For example, '2E E0 00 00' is swapped and converted into a decimal number, 12000.

**(4) Read Input Register (0x04)**

It reads single registers (16-bit data) and continuous register binary (16 bit data) values.

■ **Request**

Function Code	1Byte	0x04
Starting Address	2Byte	0x0000 to 0xFFFF
Quantity of Registers	2Bytes	0x0000 to 0x007D

■ **Request OK**

Function Code	1Byte	0x04
Starting Address	1Byte	2 x N*
Quantity of Registers	N* x 2Bytes	

\*N= Quantity of Input Registers

■ **Response not OK**

Error Code	1Byte	0x84
Exception Code	1Byte	0x01~0x06

ex1) When reading the parameter value of drive status output 1 (Address: 0x2121)



### ■ Request

Node ID	Function	Starting Address Hi	Starting Address Lo	Quantity of Register Hi	Quantity of Register Lo	CRC Hi	CRC Lo
0x01	0x04	0x21	0x21	0x00	0x01	0x6B	0xFC

### ■ Request OK

Node ID	Function	Byte Count	Register Value Hi	Register Value Lo	CRC Hi	CRC Lo
0x01	0x04	0x02	0x04	0x99	0x7B	0x9A

- Drive status output 1 (Address: 0x2121) is 0b10010011001 (0x0499), BRAKE, ZSPD, INPOS1, INSPD, INPOS2 contacts in High (Status 1) are output.

### ■ Response not OK

Node ID	Error Code	Exception Code	CRC Hi	CRC Lo
0x01	0x84	0x01~0x06	-	-

**(5) Write Single Coil (0x05)**

It turns on or off individual bit input vales

■ **Request**

Function Code	1Byte	0x05
Output Address	2Byte	0x0000 to 0xFFFF
Output Value	2Bytes	0x0000 or 0xFF00

■ **Request OK**

Function Code	1Byte	0x05
Output Address	2Byte	0x0000 to 0xFFFF
Output Value	2Byte	0x0000 or 0xFF00

■ **Response not OK**

Error Code	1Byte	0x85
Exception Code	1Byte	0x01~0x04

The command code Write Single Coil can control input of individual bits that correspond to drive status input 1, 2. The following are the addresses that correspond to drive status input 1, 2.

### ■ Drive Status Input 1, 2 Communication Addresses

Communication Address		Output Contacts	Accessibility	Communication Address		Output Contacts	Accessibility
Decimal Numbers	Hexadecimal Numbers			Decimal Numbers	Hexadecimal Numbers		
0	0x0000	POT	RW	16	0x0010	START	RW
1	0x0001	NOT	RW	17	0x0011	PAUSE	RW
2	0x0002	HOME	RW	18	0x0012	REGT	RW
3	0x0003	STOP	RW	19	0x0013	HSTART	RW
4	0x0004	PCON	RW	20	0x0014	ISEL0	RW
5	0x0005	GAIN2	RW	21	0x0015	ISEL1	RW
6	0x0006	P_CL	RW	22	0x0016	ISEL2	RW
7	0x0007	N_CL	RW	23	0x0017	ISEL3	RW
8	0x0008	MODE	RW	24	0x0018	ISEL4	RW
9	0x0009	Reserved	RW	25	0x0019	ISEL5	RW
10	0x000A	EMG	RW	26	0x001A	ABSRQ	RW
11	0x000B	A_RST	RW	27	0x001B	JSTART	RW
12	0x000C	SV_ON	RW	28	0x001C	JDIR	RW
13	0x000D	SPD1/LVSF 1	RW	29	0x001D	PCLEAR	RW
14	0x000E	SPD2/LVSF 2	RW	30	0x001E	AOVR	RW
15	0x000F	SPD3	RW	31	0x001F	Reserved	RW

ex) Writing POT input contact status ON

■ Request

Node ID	Function	Output Address Hi	Output Address Lo	Output Value Hi	Output Value Lo	CRC Hi	CRC Lo
0x01	0x05	0x00	0x00	0xFF	0x00	0X8C	0x3A

■ Request OK

Node ID	Function	Output Address Hi	Output Address Lo	Output Value Hi	Output Value Lo	CRC Hi	CRC Lo
0x01	0x05	0x00	0x00	0xFF	0x00	0X8C	0x3A

■ Response not OK

Node ID	Error Code	Exception Code	CRC Hi	CRC Lo
0x01	0x85	0x01~0x04	-	-

ex) Writing POT input contact status OFF

■ Request

Node ID	Function	Output Address Hi	Output Address Lo	Output Value Hi	Output Value Lo	CRC Hi	CRC Lo
0x01	0x05	0x00	0x00	0x00	0x00	0xCD	0xCA

■ Request OK

Node ID	Function	Output Address Hi	Output Address Lo	Output Value Hi	Output Value Lo	CRC Hi	CRC Lo
0x01	0x05	0x00	0x00	0x00	0x00	0XCD	0xCA

■ Response not OK

Node ID	Error Code	Exception Code	CRC Hi	CRC Lo
0x01	0x85	0x01~0x04	-	-

## 1) Example of Digital I/O Status Value Protocol

Function	Write contact state ON	Write contact state OFF
POT	[01][05][00][00][FF][00][8C][3A]	[01][05][00][00][00][00][CD][CA]
NOT	[01][05][00][01][FF][00][DD][FA]	[01][05][00][01][00][00][9C][0A]
HOME	[01][05][00][02][FF][00][2D][FA]	[01][05][00][02][00][00][6C][0A]
STOP	[01][05][00][03][FF][00][7C][3A]	[01][05][00][03][00][00][3D][CA]
PCON	[01][05][00][04][FF][00][CD][FB]	[01][05][00][04][00][00][8C][0B]
GAIN2	[01][05][00][05][FF][00][9C][3B]	[01][05][00][05][00][00][DD][CB]
P_CL	[01][05][00][06][FF][00][6C][3B]	[01][05][00][06][00][00][2D][CB]
N_CL	[01][05][00][07][FF][00][3D][FB]	[01][05][00][07][00][00][7C][0B]
MODE	[01][05][00][08][FF][00][0D][F8]	[01][05][00][08][00][00][4C][08]
EMG	[01][05][00][0A][FF][00][AC][38]	[01][05][00][0A][00][00][ED][C8]
A_RST	[01][05][00][0B][FF][00][FD][F8]	[01][05][00][0B][00][00][BC][08]
SV_ON	[01][05][00][0C][FF][00][4C][39]	[01][05][00][0C][00][00][0D][C9]
SPD1/LVSF1	[01][05][00][0D][FF][00][1D][F9]	[01][05][00][0D][00][00][5C][09]
SPD2/LVSF2	[01][05][00][0E][FF][00][ED][F9]	[01][05][00][0E][00][00][AC][09]
SPD3	[01][05][00][0F][FF][00][BC][39]	[01][05][00][0F][00][00][FD][C9]
START	[01][05][00][10][FF][00][8D][FF]	[01][05][00][10][00][00][CC][0F]
PAUSE	[01][05][00][11][FF][00][DC][3F]	[01][05][00][11][00][00][9D][CF]
REGT	[01][05][00][12][FF][00][2C][3F]	[01][05][00][12][00][00][6D][CF]
HSTART	[01][05][00][13][FF][00][7D][FF]	[01][05][00][13][00][00][3C][0F]
ISEL0	[01][05][00][14][FF][00][CC][3E]	[01][05][00][14][00][00][8D][CE]
ISEL1	[01][05][00][15][FF][00][9D][FE]	[01][05][00][15][00][00][DC][0E]
ISEL2	[01][05][00][16][FF][00][6D][FE]	[01][05][00][16][00][00][2C][0E]
ISEL3	[01][05][00][17][FF][00][3C][3E]	[01][05][00][17][00][00][7D][CE]
ISEL4	[01][05][00][18][FF][00][0C][3D]	[01][05][00][18][00][00][4D][CD]
ISEL5	[01][05][00][19][FF][00][5D][FD]	[01][05][00][19][00][00][1C][0D]
ABSRQ	[01][05][00][1A][FF][00][AD][FD]	[01][05][00][1A][00][00][EC][0D]
JSTART	[01][05][00][1B][FF][00][FC][3D]	[01][05][00][1B][00][00][BD][CD]
JDIR	[01][05][00][1C][FF][00][4D][FC]	[01][05][00][1C][00][00][0C][0C]
PCLEAR	[01][05][00][1D][FF][00][1C][3C]	[01][05][00][1D][00][00][5D][CC]
AOVR	[01][05][00][1E][FF][00][EC][3C]	[01][05][00][1E][00][00][AD][CC]

**(6) Write Single Register (0x06)**

It writes values on the single register (16-bit data).

**■ Request**

Function Code	1Byte	0x06
Starting Address	2Bytes	0x0000 to 0xFFFF
Quantity of Registers	2Bytes	0x0000 to 0xFFFF

**■ Request OK**

Function Code	1Byte	0x06
Starting Address	2Bytes	0x0000 to 0xFFFF
Quantity of Registers	2Bytes	0x0000 to 0xFFFF

**■ Response not OK**

Error Code	1Byte	0x86
Exception Code	1Byte	0x01~0x06

ex 1) when changing inertia ratio (Address: 0x2100) to 200

**■ Request**

Node ID	Function	Starting Address Hi	Starting Address Lo	Quantity of Register Hi	Quantity of Register Lo	CRC Hi	CRC Lo
0x01	0x06	0x21	0x00	0x00	0xC8	0x82	0x60

**■ Request OK**

Node ID	Function	Starting Address Hi	Starting Address Lo	Quantity of Register Hi	Quantity of Register Lo	CRC Hi	CRC Lo
0x01	0x06	0x21	0x00	0x00	0xC8	0x82	0x60

- It changes the inertia ratio value (Address: 0x2100) to 200 (or 0x00C8).

**■ Response not OK**

Node ID	Error Code	Exception Code	CRC Hi	CRC Lo
0x01	0x86	0x01~0x06	-	-

**(7) Write Multiple Coils (0x0F)**

It turns on or off continual bit input values.

■ **Request**

Function Code	1Byte	0x0F
Starting Address	2Byte	0x0000 to 0xFFFF
Quantity of Outputs	2Bytes	0x0000 or 0xFF00
Byte Count	1Bytes	N*
Output Value	N* x 1Byte	

\*N= Quantity of Outputs/8

■ **Request OK**

Function Code	1Byte	0x0F
Starting Address	2Byte	0x0000 to 0xFFFF
Quantity of Outputs	2Byte	0x0001 or 0x07B0

■ **Response not OK**

Error Code	1Byte	0x8F
Exception Code	1Byte	0x01~0x04

The command code Write Multiple Coil can control continual input of bits that correspond to drive status input 1, 2. The following are the addresses that correspond to drive status input 1, 2.

### ■ Drive Status Input 1, 2 Communication Addresses

Communication Address		Output Contacts	Accessibility	Communication Address		Output Contacts	Accessibility
Decimal Numbers	Hexadecimal Numbers			Decimal Numbers	Hexadecimal Numbers		
0	0x0000	POT	RW	16	0x0010	START	RW
1	0x0001	NOT	RW	17	0x0011	PAUSE	RW
2	0x0002	HOME	RW	18	0x0012	REGT	RW
3	0x0003	STOP	RW	19	0x0013	HSTART	RW
4	0x0004	PCON	RW	20	0x0014	ISEL0	RW
5	0x0005	GAIN2	RW	21	0x0015	ISEL1	RW
6	0x0006	P_CL	RW	22	0x0016	ISEL2	RW
7	0x0007	N_CL	RW	23	0x0017	ISEL3	RW
8	0x0008	MODE	RW	24	0x0018	ISEL4	RW
9	0x0009	Reserved	RW	25	0x0019	ISEL5	RW
10	0x000A	EMG	RW	26	0x001A	ABSRQ	RW
11	0x000B	A_RST	RW	27	0x001B	JSTART	RW
12	0x000C	SV_ON	RW	28	0x001C	JDIR	RW
13	0x000D	SPD1/LVSF 1	RW	29	0x001D	PCLEAR	RW
14	0x000E	SPD2/LVSF 2	RW	30	0x001E	AOVR	RW
15	0x000F	SPD3	RW	31	0x001F	Reserved	RW



ex1) Writing POT and EMG input contacts ON

### ■ Request

Node ID	Function	Starting Address Hi	Starting Address Lo	Quantity of Outputs Hi	Quantity of Outputs Lo	Byte Count
0x01	0x0F	0x00	0x00	0x00	0x0B	0x02

Outputs Value Hi	Output Value Lo	CRC Hi	CRC Lo
0X01	0x04	0xE4	0x97

### ■ Request OK

Node ID	Function	Starting Address Hi	Starting Address Lo	Quantity of Outputs Hi	Quantity of Outputs Lo	CRC Hi	CRC Lo
0x01	0x0F	0x00	0x00	0x00	0x0B	0X14	0x0C

### ■ Response not OK

Node ID	Error Code	Exception Code	CRC Hi	CRC Lo
0x01	0x8F	0x01~0x04	-	-

## POT and EMG signals ON

ID	Function	Start Address		Quantity of Outputs		Byte Count	Output Value		CRC	
01	0F	00	00	00	0F	02	01	04	E4	97

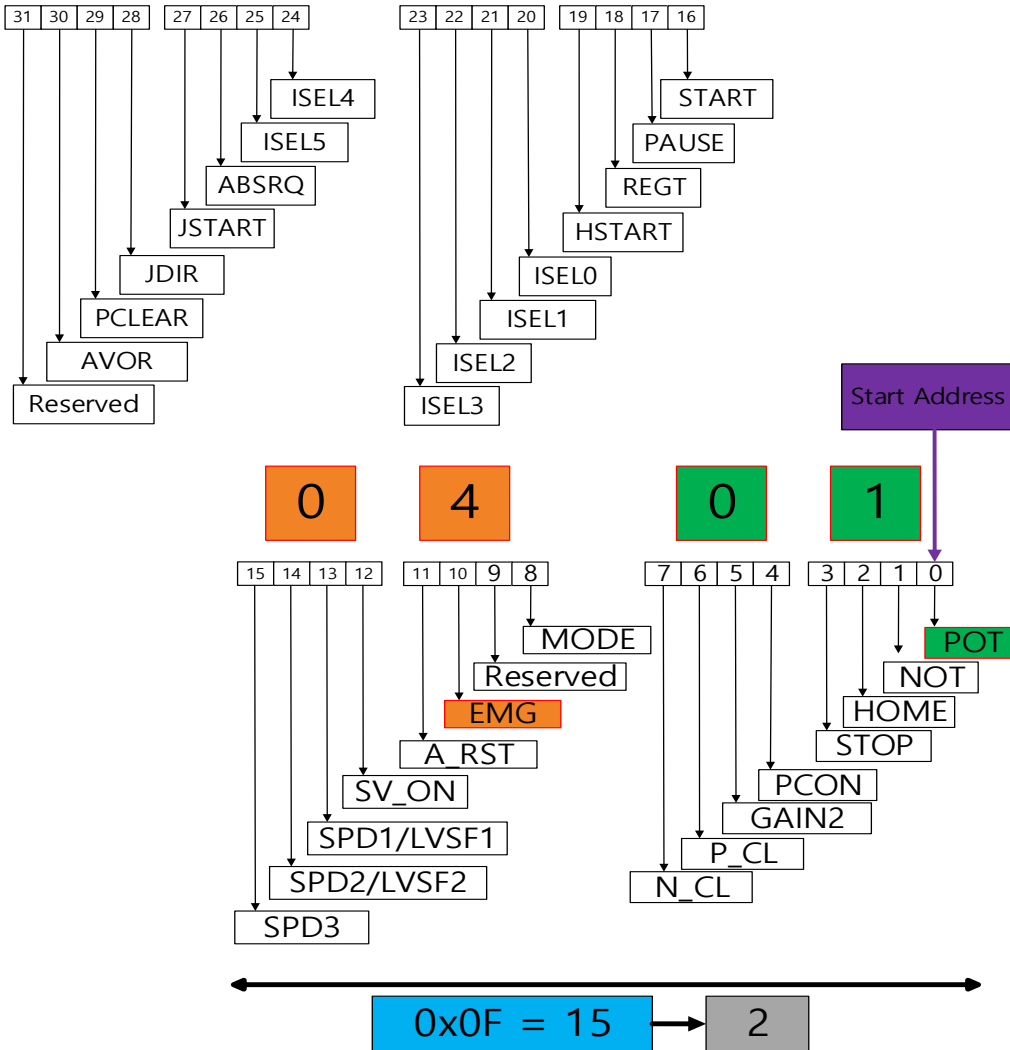

When you assign 15 Quantity Of Outputs while starting from 0x00 for the starting address, you can control the input up to 0x14. As the upper and lower Output Values are swapped, please be careful when you input them. When you input '01 04', for example, they will be swapped into '04 01'. 04 will turn on EMG, the 10th bit, and '01' will turn on POT, the 0th Bit.

# SV\_ON signal ON

ID	Function	Start Address	Quantity of Outputs	Byte Count	Output Value	CRC
01	0F	00 00	00 0F	02	00 10	E4 38

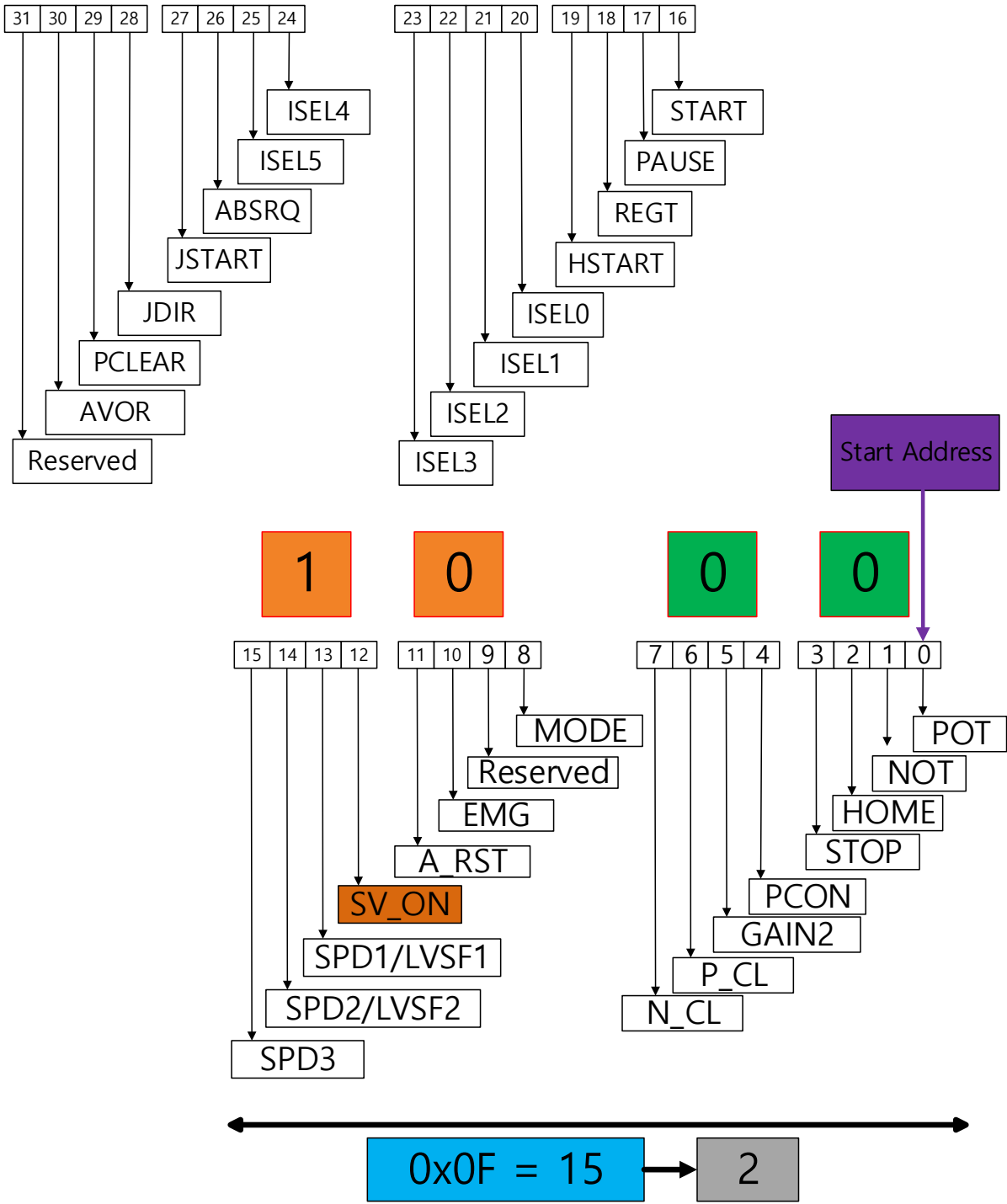

# Alarm Reset and EMG signal ON

ID	Function	Start Address		Quantity of Outputs		Byte Count	Output Value		CRC	
01	0F	00	00	00	0F	02	00	0B	A4	33

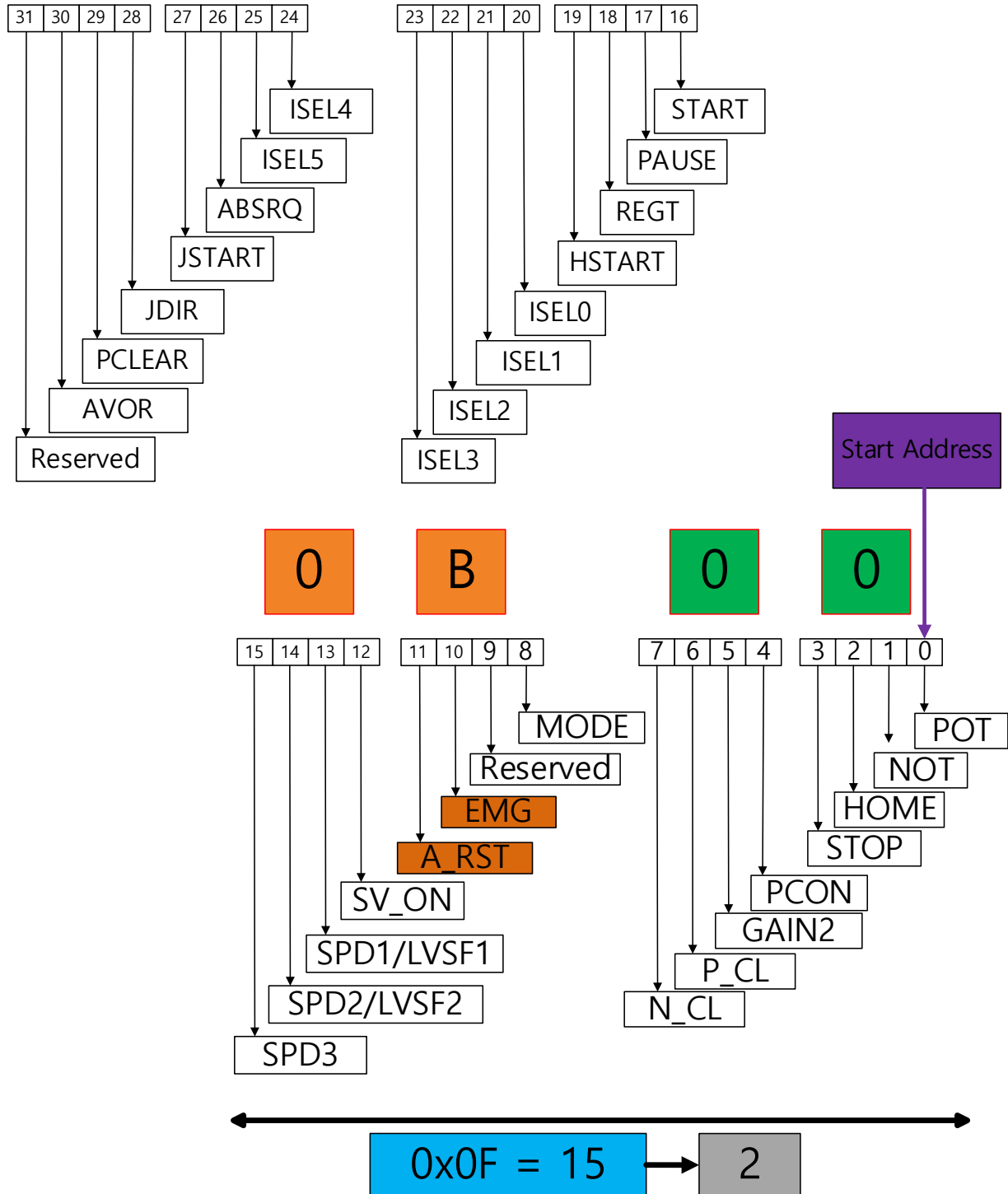

**(8) Write Multi Register (0x10)**

Writes values on the continuous register block (16-bit data).

**■ Request**

Function Code	1Byte	0x10
Starting Address	2Bytes	0x0000 to 0xFFFF
Quantity of Registers	2Bytes	0x0001 to 0x007B
Byte Count	1Byte	2 x N*
Registers Value	N* x 2Bytes	value

\*N= Quantity of Registers

**■ Request OK**

Function Code	1Byte	0x10
Starting Address	2Byte	0x0000 to 0xFFFF
Quantity of Registers	2Byte	1 to 123(0x7B)

**■ Response not OK**

Error Code	1Byte	0x90
Exception Code	1Byte	0x01~0x06

ex 1) When using multiple parameters including jog speed (Address: 0x2300), speed command acceleration time (Address: 0x2301), speed command deceleration time (Address: 0x2302)

**■ Request**

Node ID	Function	Starting Address Hi	Starting Address Lo	Quantity of Register Hi	Quantity of Register Lo	Byte Count
0x01	0x10	0x23	0x00	0x00	0x03	0x06

Registers Value Hi	Registers Value Lo	Registers Value Hi	Registers Value Lo	Registers Value Hi	Registers Value Lo	CRC Hi	CRC Lo
0xF4	0x48	0x00	0x64	0x00	0x64	0XF7	0x4A

- Jog speed (Address: 0x2300) is changed to -3000 (or 0xF448) and speed command acceleration time (Address: 0x2301) and speed command deceleration time (Address: 0x2302) is changed to 100 (or 0x0064).

**■ Request OK**

Node ID	Function	Starting Address Hi	Starting Address Lo	Quantity of Register Hi	Quantity of Register Lo	CRC Hi	CRC Lo
0x01	0x10	0x23	0x00	0x00	0x03	0X8B	0X8C

**■ Response not OK**

Node ID	Error Code	Exception Code	CRC Hi	CRC Lo
0x01	0x90	0x01~0x06	-	-

**\*Protocol example\***  
 Jog Operation Speed[0x2300] : -3000  
 Speed Command Acceleration Time[0x2301] : 100  
 Speed Command Deceleration Time[0x2302] : 100

ID	Function	Start Address		Quantity of Register		Byte Count
01	10	23	00	00	03	06

Parameter name	Communication address	Value	Number of registers
Jog Operation Speed	0x2300	-3000	1
Speed Command Acceleration Time	0x2301	100	1
Speed Command Deceleration Time	0x2302	100	1

Register		Register		Register		CRC	
F4	48	00	64	00	64	F7	4A

When you input -3000, "F4 48" is input in the register. The following example shows the conversion process. Refer to the example.

## - Example of protocol change for an input of 3000

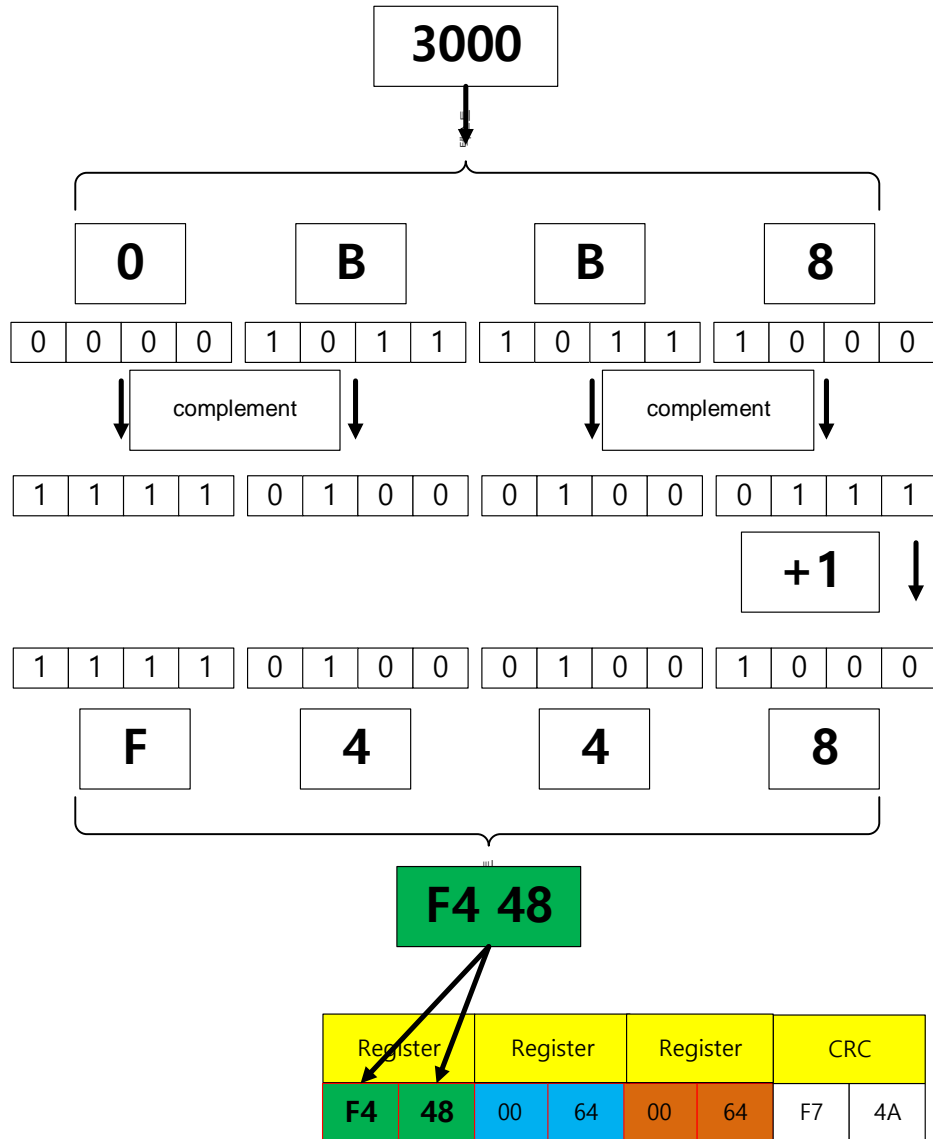

When you input -3000, 3000 is converted into a hexadecimal number first. The complement is taken and 1 is added to the 0th bit.

When the complement is taken, the value is F4 48. If you input the value in the register, -3000 is input. For reading, follow the opposite order to see the result value.

**\*Protocol example\***

Position Loop Gain 1[0x2101] : 25  
 Speed Loop Gain 1[0x2102] : 65  
 Speed Loop Integral Time Constant 1[0x2103] : 150

ID	Function	Start Address		Quantity of Register		Byte Count
01	10	21	01	00	03	06

Parameter name	Communication address	Value	Number of registers
Position Loop Gain 1	0x2101	25	1
Speed Loop Gain 1	0x2102	65	1
Speed Loop Integral Time Constant 1	0x2103	150	1

Register		Register		Register		CRC	
00	19	00	41	00	96	D5	C1



**\*Protocol example\***

Index0.IndexType[0x3101] : 0  
 Index0.Distance[0x3102] : 51200000  
 Index0.Velocity[0x3104] : 87381

ID	Function	Start Address		Quantity of Register		Byte Count
01	10	31	01	00	05	0A

Parameter name	Communication address	Value	Number of registers
Index0.IndexType	0x3101	0	1
Index0.Distance	0x3102	51200000	2
Index0.Velocity	0x3104	87381	2

Register		Register				Register				CRC	
00	00	40	00	03	0D	55	55	00	01	19	F3

The number of registers differ for each parameter. To determine the value of Quantity of Register, find out the variable format on the communication address table. The register quantity is 1 for 16 [bit] and 2 for 32 [bit]. Add the values and input the result value. Input the value twice Quantity of Register for Byte Count.

## 16.3 Parameter Saving & Reset

Apart from saving individual parameters [0x240E], you can save or reset parameters using below commands.

### - Parameter Saving

#### ■ Request

Node ID	Function	Starting Address Hi	Starting Address Lo	Quantity of Register Hi	Quantity of Register Lo	Byte Count
0x01	0x10	0x10	0x0C	0x00	0x02	0x04

Registers Value Hi	Registers Value Lo	Registers Value Hi	Registers Value Lo	CRC Hi	CRC Lo
0x61	0x73	0x65	0x76	0x7A	0xAB

#### ■ Request OK

Node ID	Function	Starting Address Hi	Starting Address Lo	Quantity of Register Hi	Quantity of Register Lo	CRC Hi	CRC Lo
0x01	0x10	0x10	0x0C	0x00	0x02	0x85	0x0B

**- Parameter Restoration****■ Request**

Node ID	Function	Starting Address Hi	Starting Address Lo	Quantity of Register Hi	Quantity of Register Lo	Byte Count
0x01	0x10	0x10	0x16	0x00	0x02	0x04

Registers Value Hi	Registers Value Lo	Registers Value Hi	Registers Value Lo	CRC Hi	CRC Lo
0x6F	0x6C	0x64	0x61	0x89	0x68

**■ Request OK**

Node ID	Function	Starting Address Hi	Starting Address Lo	Quantity of Register Hi	Quantity of Register Lo	CRC Hi	CRC Lo
0x01	0x10	0x10	0x16	0x00	0x02	0xA4	0xCC

## 16.4 L7C Servo Drive Communication Address Table

### 16.4.1 Basic Setting Parameters

Communication Address		Parameter Names	Parameter Numbers	Variable Types	Initial Values	Minimum Values	Maximum Values	Units	Accessibility
Decimal Numbers	Hexadecimal Numbers								
8192	0x2000	Motor ID	0x2000	UINT	13	1	9999	-	RW
8193	0x2001	Encoder Type	0x2001	UINT	1	0	2	-	RW
8194	0x2002	Encoder Pulse per Revolution	0x2002	UDINT	524288	0	1073741824	pulse	RW
8196	0x2004	Node ID	0x2003	UINT	1	1	99		RW
8197	0x2005	Rotation Direction Select	0x2004	UINT	0	0	1	-	RW
8198	0x2006	Absolute Encoder Configuration	0x2005	UINT	1	0	2	-	RW
8199	0x2007	Main Power Fail Check Mode	0x2006	UINT	0	0	255	-	RW
8200	0x2008	Main Power Fail Check Time	0x2007	UINT	20	0	5000	ms	RW
8201	0x2009	7SEG Display Selection	0x2008	UINT	0	0	100	-	RW
8202	0x200A	Regeneration Brake <input type="checkbox"/> Resistor Configuration	0x2009	UINT	1	0	1	-	RW
8203	0x200B	Regeneration Brake <input type="checkbox"/> Resistor Derating Factor	0x200A	UINT	100	0	200	%	RW
8204	0x200C	Regeneration Brake <input type="checkbox"/> Resistor Value	0x200B	UINT	0	0	1000	ohm	RW
8205	0x200D	Regeneration Brake <input type="checkbox"/> Resistor Power	0x200C	UINT	0	0	30000	watt	RW
8206	0x200E	Peak Power of Regeneration <input type="checkbox"/> Brake Resistor	0x200D	UINT	100	1	50000	watt	RW
8207	0x200F	Duration Time @ Peak Power of Regeneration Brake Resistor	0x200E	UINT	5000	1	50000	ms	RW
8208	0x2010	Overload Check Base	0x200F	UINT	100	10	120	%	RW
8209	0x2011	Overload Warning Level	0x2010	UINT	50	10	100	%	RW
8210	0x2012	PWM Off Delay Time	0x2011	UINT	10	0	1000	ms	RW
8211	0x2013	Dynamic Brake Control Mode	0x2012	UINT	0	0	3	-	RW
8212	0x2014	Emergency Stop Configuration	0x2013	UINT	1	0	1	-	RW
8213	0x2015	Warning Mask Configuration	0x2014	UINT	0	0	0xFFFF	-	RW
8214	0x2016	U Phase Current Offset	0x2015	INT	0	-1000	1000	0.10%	RW

8215	0x2017	V Phase Current Offset	0x2016	INT	0	-1000	1000	0.10%	RW
8216	0x2018	W Phase Current Offset	0x2017	INT	0	-1000	1000	0.10%	RW
8217	0x2019	Magnetic Pole Pitch	0x2018	UINT	2400	1	65535	0.01mm	RW
8218	0x201A	Linear Scale Resolution	0x2019	UINT	1000	1	65535	nm	RW
8219	0x201B	Commutation Method	0x201A	UINT	0	0	2	-	RW
8220	0x201C	Commutation Current	0x201B	UINT	500	0	1000	0.10%	RW
8221	0x201D	Commutation Time	0x201C	UINT	1000	500	5000	ms	RW
8222	0x201E	Grating Period of Sinusoidal Encoder	0x201D	UINT	40	1	65535	Um	RW
8223	0x201F	Homing Done Behavior	0x201E	UINT	0	0	1	-	RW
8224	0x2020	Velocity Function Select	0x201F	UINT	0	0	2	-	RW
8225	0x2021	Motor Hall Phase Config.	0x2020	UINT	0	0	65535	-	RW

## 16.4.2 Gain Adjustment Parameters

Communication Address		Parameter Names	Parameter Numbers	Variable Types	Initial Values	Minimum Values	Maximum Values	Units	Accessibility
Decimal Numbers	Hexadecimal Numbers								
8448	0x2100	Inertia Ratio	0x2100	UINT	100	0	3000	%	RW
8449	0x2101	Position Loop Gain 1	0x2101	UINT	50	1	500	1/s	RW
8450	0x2102	Speed Loop Gain 1	0x2102	UINT	75	1	2000	Hz	RW
8451	0x2103	Speed Loop Integral Time Constant 1	0x2103	UINT	50	1	1000	ms	RW
8452	0x2104	Torque Command Filter Time Constant 1	0x2104	UINT	5	0	1000	0.1ms	RW
8453	0x2105	Position Loop Gain 2	0x2105	UINT	30	1	500	1/s	RW
8454	0x2106	Speed Loop Gain 2	0x2106	UINT	50	1	2000	Hz	RW
8455	0x2107	Speed Loop Integral Time Constant 2	0x2107	UINT	50	1	1000	ms	RW
8456	0x2108	Torque Command Filter Time Constant 2	0x2108	UINT	5	0	1000	0.1ms	RW
8457	0x2109	Position Command Filter Time Constant	0x2109	UINT	0	0	10000	0.1ms	RW
8458	0x210A	Position Command Average Filter Time Constant	0x210A	UINT	0	0	10000	0.1ms	RW
8459	0x210B	Speed Feedback Filter Time Constant	0x210B	UINT	5	0	10000	0.1ms	RW
8460	0x210C	Velocity Feed-forward Gain	0x210C	UINT	0	0	100	%	RW
8461	0x210D	Velocity Feed-forward Filter Time Constant	0x210D	UINT	10	0	1000	0.1ms	RW
8462	0x210E	Torque Feed-forward Gain	0x210E	UINT	0	0	100	%	RW
8463	0x210F	Torque Feed-forward Filter Time Constant	0x210F	UINT	10	0	1000	0.1ms	RW
8464	0x2110	Torque Limit Function Select	0x2110	UINT	2	0	4	-	RW
8465	0x2111	External Positive Torque Limit Value	0x2111	UINT	3000	0	5000	0.1%	RW
8466	0x2112	External Negative Torque Limit Value	0x2112	UINT	3000	0	5000	0.1%	RW
8467	0x2113	Emergency Stop Torque	0x2113	UINT	1000	0	5000	0.1%	RW
8468	0x2114	P/PI Control Conversion Mode	0x2114	UINT	0	0	4	-	RW
8469	0x2115	P Control Switch Torque	0x2115	UINT	500	0	5000	0.1%	RW

8470	0x2116	P Control Switch Speed	0x2116	UINT	100	0	6000	rpm	RW
8471	0x2117	P Control Switch Acceleration	0x2117	UINT	1000	0	60000	rpm/s	RW
8472	0x2118	P Control Switch Following Error	0x2118	UINT	100	0	60000	pulse	RW
8473	0x2119	Gain Conversion Mode	0x2119	UINT	0	0	7	-	RW
8474	0x211A	Gain Conversion Time 1	0x211A	UINT	2	0	1000	ms	RW
8475	0x211B	Gain Conversion Time 2	0x211B	UINT	2	0	1000	ms	RW
8476	0x211C	Gain Conversion Waiting Time 1	0x211C	UINT	0	0	1000	ms	RW
8477	0x211D	Gain Conversion Waiting Time 2	0x211D	UINT	0	0	1000	ms	RW
8478	0x211E	Dead Band for Position Control	0x211E	UINT	0	0	1000	UU	RW
8479	0x211F	Drive Control Input 1	0x211F	UINT	0	0	0xFFFF	-	RW
8480	0x2120	Drive Control Input 2	0x2120	UINT	0	0	0xFFFF	-	RW
8481	0x2121	Drive Status Output 1	0x2121	UINT	0	0	0xFFFF	-	RO
8482	0x2122	Drive Status Output 2	0x2122	UINT	0	0	0xFFFF	-	RO

### 16.4.3 I/O Configuration Parameters

Communication Address		Parameter Names	Parameter Numbers	Variable Types	Initial Values	Minimum Values	Maximum Values	Units	Accessibility
Decimal Numbers	Hexadecimal Numbers								
8704	0x2200	Digital Input Signal 1 Selection	0x2200	UINT	0x000F	0	0xFFFF	-	RW
8705	0x2201	Digital Input Signal 2 Selection	0x2201	UINT	0x0020	0	0xFFFF	-	RW
8706	0x2202	Digital Input Signal 3 Selection	0x2202	UINT	0x0021	0	0xFFFF	-	RW
8707	0x2203	Digital Input Signal 4 Selection	0x2203	UINT	0x0022	0	0xFFFF	-	RW
8708	0x2204	Digital Input Signal 5 Selection	0x2204	UINT	0x000C	0	0xFFFF	-	RW
8709	0x2205	Digital Input Signal 6 Selection	0x2205	UINT	0x001C	0	0xFFFF	-	RW
8710	0x2206	Digital Input Signal 7 Selection	0x2206	UINT	0x0001	0	0xFFFF	-	RW
8711	0x2207	Digital Input Signal 8 Selection	0x2207	UINT	0x0002	0	0xFFFF	-	RW
8712	0x2208	Digital Input Signal 9 Selection	0x2208	UINT	0x000B	0	0xFFFF	-	RW
8713	0x2209	Digital Input Signal 10 Selection	0x2209	UINT	0x0004	0	0xFFFF	-	RW
8714	0x220A	Digital Output Signal 1 Selection	0x220A	UINT	0x8002	0	0xFFFF	-	RW
8715	0x220B	Digital Output Signal 2 Selection	0x220B	UINT	0x0003	0	0xFFFF	-	RW
8716	0x220C	Digital Output Signal 3 Selection	0x220C	UINT	0x0004	0	0xFFFF	-	RW
8717	0x220D	Digital Output Signal 4 Selection	0x220D	UINT	0x8001	0	0xFFFF	-	RW
8718	0x220E	Digital Output Signal 5 Selection	0x220E	UINT	0x0005	0	0xFFFF	-	RW
8719	0x220F	Analog Velocity Override Mode	0x220F	UINT	0	0	1	-	RW
8720	0x2210	Analog Torque Input(command/limit) Scale	0x2210	UINT	100	-1000	1000	0.1%/V	RW
8721	0x2211	Analog Torque Input (command/limit) Offset	0x2211	INT	0	-1000	1000	mV	RW
8722	0x2212	Analog Torque Command Clamp Level	0x2212	UINT	0	0	1000	-	RW

8723	0x2213	Analog Torque Command Filter Time Constant	0x2213	UINT	2	0	1000	-	RW
8724	0x22174	Analog Velocity Command Scale	0x2214	INT	100	-1000	1000	-	RW
8725	0x2215	Analog Velocity Input (command/override) Offset	0x2215	INT	0	-1000	1000	mV	RW
8726	0x2216	Analog Velocity Command Clamp Level	0x2216	UINT	0	0	1000	-	RW
8727	0x2217	Analog Velocity Command Filter Time Constant	0x2217	UINT	2	0	1000	-	RW

### 16.4.4 Velocity Control Parameters

Communication Address		Parameter Names	Parameter Numbers	Variable Types	Initial Values	Minimum Values	Maximum Values	Units	Accessibility
Decimal Numbers	Hexadecimal Numbers								
8960	0x2300	Jog Operation Speed	0x2300	INT	500	-6000	6000	rpm	RW
8961	0x2301	Speed Command Acceleration Time	0x2301	UINT	200	0	10000	ms	RW
8962	0x2302	Speed Command Deceleration Time	0x2302	UINT	200	0	10000	ms	RW
8963	0x2303	Speed Command S-curve Time	0x2303	UINT	0	0	1000	ms	RW
8964	0x2304	Program Jog Operation Speed 1	0x2304	INT	0	-6000	6000	rpm	RW
8965	0x2305	Program Jog Operation Speed 2	0x2305	INT	500	-6000	6000	rpm	RW
8966	0x2306	Program Jog Operation Speed 3	0x2306	INT	0	-6000	6000	rpm	RW
8967	0x2307	Program Jog Operation Speed 4	0x2307	INT	-500	-6000	6000	rpm	RW
8968	0x2308	Program Jog Operation Time 1	0x2308	UINT	500	0	10000	ms	RW
8969	0x2309	Program Jog Operation Time 2	0x2309	UINT	5000	0	10000	ms	RW
8970	0x230A	Program Jog Operation Time 3	0x230A	UINT	500	0	10000	ms	RW
8971	0x230B	Program Jog Operation Time 4	0x230B	UINT	5000	0	10000	ms	RW
8972	0x230C	Index Pulse Search Speed	0x230C	INT	20	-1000	1000	rpm	RW
8973	0x230D	Speed Limit Function Select	0x230D	UINT	0	0	3	-	RW
8974	0x230E	Velocity Limit Value at Torque Control Mode	0x230E	UINT	1000	0	6000	rpm	RW
8975	0x230F	Over Speed Detection Level	0x230F	UINT	6000	0	10000	rpm	RW
8976	0x2310	Excessive Speed Error Detection Level	0x2310	UINT	5000	0	10000	rpm	RW
8977	0x2311	Servo-Lock Function Select	0x2311	UINT	0	0	1	-	RW
8978	0x2312	Multi-Step Operation Velocity 1	0x2312	INT	0	-32768	32767	rpm	RW
8979	0x2313	Multi-Step Operation Velocity 2	0x2313	INT	10	-32768	32767	rpm	RW
8980	0x2314	Multi-Step Operation Velocity 3	0x2314	INT	50	-32768	32767	rpm	RW
8981	0x2315	Multi-Step Operation Velocity 4	0x2315	INT	100	-32768	32767	rpm	RW
8982	0x2316	Multi-Step Operation Velocity 5	0x2316	INT	200	-32768	32767	rpm	RW
8983	0x2317	Multi-Step Operation Velocity 6	0x2317	INT	500	-32768	32767	rpm	RW



8984	0x2318	Multi-Step Operation Velocity 7	0x2318	INT	1000	-32768	32767	rpm	RW
8985	0x2319	Multi-Step Operation Velocity 8	0x2319	INT	1500	-32768	32767	rpm	RW
8986	0x231A	Velocity Command Switch Select	0x231A	UINT	0	0	3	-	RW
								-	

## 16.4.5 Miscellaneous Setting Parameters

Communication Address		Parameter Names	Parameter Numbers	Variable Types	Initial Values	Minimum Values	Maximum Values	Units	Accessibility
Decimal Numbers	Hexadecimal Numbers								
9216	0x2400	Software Position Limit Function Select	0x2400	UINT	0	0	3	-	RW
9217	0x2401	INPOS1 Output Range	0x2401	UINT	100	0	60000	UU	RW
9218	0x2402	INPOS1 Output Time	0x2402	UINT	0	0	1000	ms	RW
9219	0x2403	INPOS2 Output Range	0x2403	UINT	100	0	60000	UU	RW
9220	0x2404	ZSPD Output Range	0x2404	UINT	10	0	6000	rpm	RW
9221	0x2405	TGON Output Range	0x2405	UINT	100	0	6000	rpm	RW
9222	0x2406	INSPD Output Range	0x2406	UINT	100	0	6000	rpm	RW
9223	0x2407	BRAKE Output Speed	0x2407	UINT	100	0	6000	rpm	RW
9224	0x2408	BRAKE Output Delay Time	0x2408	UINT	100	0	1000	ms	RW
9225	0x2409	Torque Limit at Homing Using Stopper	0x2409	UINT	250	0	2000	0.10%	RW
9226	0x240A	Duration Time at Homing Using Stopper	0x240A	UINT	50	0	1000	ms	RW
9227	0x240B	Modulo Mode	0x240B	UINT	0	0	5	-	RW
9228	0x240C	Modulo Factor	0x240C	DINT	3600	1	0x40000000	UU	RW
9230	0x240E	User Drive Name	0x240D	STRING	Drive			-	RW
9238	0x2416	Individual Parameter Save	0x240E	UINT	0	0	1	-	RW
9239	0x2417	RMS Overload Calculation Time	0x240F	UINT	15000	100	60000	ms	RW
9240	0x2418	RTC Time Set	0x2410	UDINT	0	0	4294967295	-	RW
9242	0x241A	RTC Data Set	0x2411	UDINT	1507585	0	4294967295	-	RW

## 16.4.6 Enhanced Control Parameters

Communication Address		Parameter Names	Parameter Numbers	Variable Types	Initial Values	Minimum Values	Maximum Values	Units	Accessibility
Decimal Numbers	Hexadecimal Numbers								
9472	0x2500	Adaptive Filter Function Select	0x2500	UINT	0	0	5	-	RW
9473	0x2501	Notch Filter 1 Frequency	0x2501	UINT	5000	50	5000	Hz	RW
9474	0x2502	Notch Filter 1 Width	0x2502	UINT	1	1	100		RW
9475	0x2503	Notch Filter 1 Depth	0x2503	UINT	1	1	5	-	RW
9476	0x2504	Notch Filter 2 Frequency	0x2504	UINT	5000	50	5000	Hz	RW
9477	0x2505	Notch Filter 2 Width	0x2505	UINT	1	1	100		RW
9478	0x2506	Notch Filter 2 Depth	0x2506	UINT	1	1	5	-	RW
9479	0x2507	Notch Filter 3 Frequency	0x2507	UINT	5000	50	5000	Hz	RW
9480	0x2508	Notch Filter 3 Width	0x2508	UINT	1	1	100		RW
9481	0x2509	Notch Filter 3 Depth	0x2509	UINT	1	1	5	-	RW
9482	0x250A	Notch Filter 4 Frequency	0x250A	UINT	5000	50	5000	Hz	RW
9483	0x250B	Notch Filter 4 Width	0x250B	UINT	1	1	100		RW
9484	0x250C	Notch Filter 4 Depth	0x250C	UINT	1	1	5	-	RW
9485	0x250D	On-line Gain Tuning Mode	0x250D	UINT	0	0	1	-	RW
9486	0x250E	System Rigidity for Gain Tuning	0x250E	UINT	5	1	20	-	RW
9487	0x250F	On-line Gain Tuning Adaptation Speed	0x250F	UINT	1	1	5	-	RW
9488	0x2510	Off-line Gain Tuning Direction	0x2510	UINT	0	0	1	-	RW
9489	0x2511	Off-line Gain Tuning Distance	0x2511	UINT	5	1	10	-	RW
9490	0x2512	Disturbance Observer Gain	0x2512	UINT	0	0	100	%	RW
9491	0x2513	Disturbance Observer Filter Time Constant	0x2513	UINT	10	0	1000	0.1ms	RW
9492	0x2514	Current Controller Gain	0x2514	UINT	100	1	150	%	RW
9493	0x2515	Vibration Suppression Filter Configuration	0x2515	UINT	0	0	5	-	RW
9494	0x2516	Vibration Suppression Filter 1 Frequency	0x2516	UINT	0	0	2000	0.1Hz	RW
9495	0x2517	Vibration Suppression Filter 1 Damping	0x2517	UINT	0	0	5	-	RW
9496	0x2518	Vibration Suppression Filter 2 Frequency	0x2518	UINT	0	0	2000	0.1Hz	RW
9497	0x2519	Vibration Suppression Filter 2 Damping	0x2519	UINT	0	0	5	-	RW

## 16.4.7 Monitoring Parameters

Communication Address		Parameter Names	Parameter Numbers	Variable Types	Initial Values	Minimum Values	Maximum Values	Units	Accessibility
Decimal Numbers	Hexadecimal Numbers								
9728	0x2600	Feedback Velocity	0x2600	INT	-	-	-	rpm	RO
9729	0x2601	Command Speed	0x2601	INT	-	-	-	rpm	RO
9730	0x2602	Following Error	0x2602	DINT	-	-	-	pulse	RO
9732	0x2604	Accumulated Operation Overload	0x2603	INT	-	-	-	0.10%	RO
9733	0x2605	Instantaneous Maximum Operation Overload	0x2604	INT	-	-	-	0.10%	RO
9734	0x2606	DC-Link Voltage	0x2605	UINT	-	-	-	Volt	RO
9735	0x2607	Accumulated Regeneration Overload	0x2606	INT	-	-	-	0.10%	RO
9736	0x2608	Single-turn Data	0x2607	UDINT	-	-	-	pulse	RO
9738	0x260A	Mechanical Angle	0x2608	UINT	-	-	-	0.1deg	RO
9739	0x260B	Electrical Angle	0x2609	INT	-	-	-	0.1deg	RO
9740	0x260C	Multi-turn Data	0x260A	DINT	-	-	-	rev	RO
9742	0x260E	Drive Temperature 1	0x260B	INT	-	-	-	°C	RO
9743	0x260F	Drive Temperature 2	0x260C	INT	-	-	-	°C	RO
9744	0x2610	Encoder Temperature	0x260D	INT	-	-	-	°C	RO
9745	0x2611	Motor Rated Speed	0x260E	UINT	-	-	-	rpm	RO
9746	0x2612	Motor Maximum Speed	0x260F	UINT	-	-	-	rpm	RO
9747	0x2613	Drive Rated Current	0x2610	UINT	-	-	-	0.1A	RO
9748	0x2614	Hardware Version	0x2611	STRING	-	-	-	-	RO
9751	0x2617	Hall Signal Display	0x2612	UINT	-	-	-	-	RO
9752	0x2618	Bootloader Version	0x2613	STRING	-	-	-	-	RO
9755	0x261B	Warning Code	0x2614	UINT	-	-	-	-	RO
9756	0x261C	Analog Input 1 Value	0x2615	INT	-	-	-	mV	RO
9757	0x261D	Analog Input 2 Value	0x2616	INT	-	-	-	mV	RO
9763	0x2623	RMS Operation Overload	0x2619	INT	-	-	-	0.1%	RO
9764	0x2624	Reserved	0x261A		-				
9765	0x2625	Reserved	0x261B		-				
9766	0x2626	Reserved	0x261C		-				
9767	0x2627	Software Version	0x261D	STRING	-				
9770	0x262A	Pulse Input Frequency	0x261E	DINT	-	-32768	32767	Kpps	RO
9772	0x262C	Torque Limit Value	0x261F	INT	-	-32768	32767	0.1%	RO
9773	0x262D	Digital Input Status	0x2620	UINT	-	0	65535		RO
9774	0x262E	Digital Output Status	0x2621	UINT	-	0	65535		RO

9776	0x2630	Current RTC Time	0x2622	UDINT	-	0	4294967295		RO
9778	0x2632	Current RTC Data	0x2623	UDINT	-	0	4294967295		RO
9780	0x2634	Position Demand Internal Value	0x2624	DINT	-	-2147483648	2147483647	pulse	RO
9782	0x2636	Position Actual Internal Value	0x2625	DINT	-	-2147483648	2147483647		RO
9784	0x2638	Cumulative Hours of Use	0x2626	UDINT	-	0	4294967295		RO
9786	0x263A	Number of Inrush Current Switching	0x2627	UDINT	-	0	4294967295		RO
9788	0x263C	Number of Dynamic Brake Switching	0x2628	DINT	-	-2147483648	2147483647		RO
9790	0x263E	Position Demand Value	0x2629	DINT	-	-2147483648	2147483647	UU	RO
9792	0x2640	Position Actual Value	0x262A	DINT	-	-2147483648	2147483647	UU	RO
9794	0x2642	Following Error Actual Value	0x262B	DINT	-	-2147483648	2147483647	UU	RO
9796	0x2644	Torque Demand Value	0x262C	INT	-	-32768	32767	0.1%	RO
9797	0x2645	Torque Actual Value	0x262D	INT	-	-32768	32767	0.1%	RO

## 16.4.8 Procedures and Alarm History

Communication Address		Parameter Names	Parameter Numbers	Variable Types	Initial Values	Minimum Values	Maximum Values	Units	Accessibility
Decimal Numbers	Hexadecimal Numbers								
9984	0x2700	Procedure Command Code	0x2700	UINT	0	0	0xFFFF	-	RW
9985	0x2701	Procedure Command Argument	0x2701	UINT	0	0	0xFFFF	-	RW

## 16.4.9 3rd Party Motor Parameters

Communication Address		Parameter Names	Parameter Numbers	Variable Types	Initial Values	Minimum Values	Maximum Values	Units	Accessibility
Decimal Numbers	Hexadecimal Numbers								
10240	0x2800	[Third Party Motor] Type	0x2800	UINT	0	0	1	-	RW
10241	0x2801	[Third Party Motor] Number of Poles	0x2801	UINT	8	2	1000	-	RW
10242	0x2802	[Third Party Motor] Rated Current	0x2802	FP32	2.89	-	-	Arms	RW
10244	0x2804	[Third Party Motor] Maximum Current	0x2803	FP32	8.67	-	-	Arms	RW
10246	0x2806	[Third Party Motor] Rated Speed	0x2804	UINT	3000	1	60000	rpm	RW
10247	0x2807	[Third Party Motor] Maximum Speed	0x2805	UINT	5000	1	60000	rpm	RW
10248	0x2808	[Third Party Motor] Inertia	0x2806	FP32	0.321	-	-	Kg	RW
10250	0x280A	[Third Party Motor] Torque Constant	0x2807	FP32	0.46	-	-	Kg.m2.10-4	RW
10252	0x280C	[Third Party Motor] Phase Resistance	0x2808	FP32	0.82	-	-	ohm	RW
10254	0x280E	[Third Party Motor] Phase Inductance	0x2809	FP32	3.66	-	-	mH	RW
10256	0x2810	[Third Party Motor] TN Curve Data 1	0x280A	UINT	3000	1	60000	rpm	RW
10258	0x2812	[Third Party Motor] TN Curve Data 2	0x280B	FP32	100	-	-	%	RW
10260	0x2814	[Third Party Motor] Hall Offset	0x280C	UINT	0	0	360	deg	RW

## 16.4.10 Index Related Parameters

Communication Address		Parameter Names	Parameter Numbers	Variable Types	Initial Values	Minimum Values	Maximum Values	Units	Accessibility
Decimal Numbers	Hexadecimal Numbers								
12288	0x3000	Control Mode	0x3000	UINT	1	0	9	-	RW
12289	0x3001	Coordinate Select	0x3001	UINT	0	0	1	-	RW
12290	0x3002	Baud Rate Select	0x3002	UINT	3	0	3	-	RW
12291	0x3003	Pulse Input Logic Select	0x3003	UINT	0	0	5	-	RW
12292	0x3004	Pulse Input Filter Select	0x3004	UINT	0	0	4	-	RW
12293	0x3005	PCLEAR Mode Select	0x3005	UINT	0	0	2	-	RW
12294	0x3006	Encoder Output Pulse	0x3006	UDINT	10000	0	2147483647	-	RW
12296	0x3008	Reserved	0x3007	-	-	-	-	-	-
12297	0x3009	Start Index Number (0-63)	0x3008	UINT	0	0	64	-	RW
12298	0x300A	Index Buffer Mode	0x3009	UINT	0	0	1	-	RW
12299	0x300B	IO Signal Configuration	0x300A	UINT	0	0	5	-	RW
12300	0x300C	REGT Configuration	0x300B	UINT	0	0	5		RW

16. Communication Protocol

12302	0x300E	Electric Gear Numerator 1	0x300C	UDINT	1	1	2147483647		RW
12304	0x3010	Electric Gear Numerator 2	0x300D	UDINT	1	1	2147483647		RW
12306	0x3012	Electric Gear Numerator 3	0x300E	UDINT	1	1	2147483647		RW
12308	0x3014	Electric Gear Numerator 4	0x300F	UDINT	1	1	2147483647		RW
12310	0x3016	Electric Gear Denomiator 1	0x3010	UDINT	1	1	2147483647		RW
12312	0x3018	Electric Gear Denomiator 1	0x3011	UDINT	1	1	2147483647		RW
12314	0x301A	Electric Gear Denomiator 1	0x3012	UDINT	1	1	2147483647		RW
12316	0x301C	Electric Gear Denomiator 1	0x3013	UDINT	1	1	2147483647		RW
12318	0x301E	Electric Gear Mode	0x3014	UINT	0	0	1		RW
12319	0x301F	Electric Gear Offset	0x3015	INT	0	-32768	32767		RW
12320	0x3020	Position Limit Function	0x3016	UINT	0	0	1		RW
12321	0x3021	Backlash Compensation	0x3017	UINT	0	0	1000		RW
12322	0x3022	Homing Method	0x3018	INT	34	-128	127		RW
12324	0x3024	Home Offset	0x3019	DINT	0	-	2147483648	2147483647	RW
12326	0x3026	Homing Speed during Search for Switch	0x301A	UDINT	500000	0	1073741824		RW
12328	0x3028	Homing Speed during Search for Zero	0x301B	UDINT	100000	0	1073741824		RW
12330	0x302A	Homing Acceleration	0x301C	UDINT	200000	0	1073741824		RW
12332	0x302C	Following Error Window	0x301D	UDINT	600000	0	1073741823		RW
12334	0x302E	Following Error Timeout	0x301E	UINT	0	0	65535		RW
12335	0x302F	Velocity Window Time	0x301F	UINT	0	0	65535		RW
12336	0x3030	Software Position Min Limit	0x3020	DINT	-	-	1073741824	1073741823	RW
12338	0x3032	Software Position Max Limit	0x3021	DINT	1000000000	-	1073741824	1073741823	RW
12340	0x3034	Positive Torque Limit	0x3022	UINT	3000	0	5000		RW
12341	0x3035	Negative Torque Limit	0x3023	UINT	3000	0	5000		RW
12342	0x3036	Quick Stop Deceleration	0x3024	UDINT	2000	0	2147483647		RW
12544	0x3100	Index00	0x3100	-	-	-	-	-	RW
12562	0x3112	Index01	0x3101	-	-	-	-	-	RW
12580	0x3124	Index02	0x3102	-	-	-	-	-	RW

12598	0x3136	Index03	0x3103	-	-	-	-	-	RW
12616	0x3148	Index04	0x3104	-	-	-	-	-	RW
12634	0x315A	Index05	0x3105	-	-	-	-	-	RW
12652	0x316C	Index06	0x3106	-	-	-	-	-	RW
12670	0x317E	Index07	0x3107	-	-	-	-	-	RW
12688	0x3190	Index08	0x3108	-	-	-	-	-	RW
12706	0x31A2	Index09	0x3109	-	-	-	-	-	RW
12724	0x31B4	Index10	0x310A	-	-	-	-	-	RW
12742	0x31C6	Index11	0x310B	-	-	-	-	-	RW
12760	0x31D8	Index12	0x310C	-	-	-	-	-	RW
12778	0x31EA	Index13	0x310D	-	-	-	-	-	RW
12796	0x31FC	Index14	0x310E	-	-	-	-	-	RW
12814	0x320E	Index15	0x310F	-	-	-	-	-	RW
12832	0x3220	Index16	0x3110	-	-	-	-	-	RW
12850	0x3232	Index17	0x3111	-	-	-	-	-	RW
12868	0x3244	Index18	0x3112	-	-	-	-	-	RW
12886	0x3256	Index19	0x3113	-	-	-	-	-	RW
12904	0x3268	Index20	0x3114	-	-	-	-	-	RW
12922	0x327A	Index21	0x3115	-	-	-	-	-	RW
12940	0x328C	Index22	0x3116	-	-	-	-	-	RW
12958	0x329E	Index23	0x3117	-	-	-	-	-	RW
12976	0x32B0	Index24	0x3118	-	-	-	-	-	RW
12994	0x32C2	Index25	0x3119	-	-	-	-	-	RW
13012	0x32D4	Index26	0x311A	-	-	-	-	-	RW
13030	0x32E6	Index27	0x311B	-	-	-	-	-	RW
13048	0x32F8	Index28	0x311C	-	-	-	-	-	RW
13066	0x330A	Index29	0x311D	-	-	-	-	-	RW
13084	0x331C	Index30	0x311E	-	-	-	-	-	RW
13102	0x332E	Index31	0x311F	-	-	-	-	-	RW
13120	0x3340	Index32	0x3120	-	-	-	-	-	RW
13138	0x3352	Index33	0x3121	-	-	-	-	-	RW
13156	0x3364	Index34	0x3122	-	-	-	-	-	RW
13174	0x3376	Index35	0x3123	-	-	-	-	-	RW
13192	0x3388	Index36	0x3124	-	-	-	-	-	RW
13210	0x339A	Index37	0x3125	-	-	-	-	-	RW
13228	0x33AC	Index38	0x3126	-	-	-	-	-	RW

13246	0x33BE	Index39	0x3127	-	-	-	-	-	RW
13264	0x33D0	Index40	0x3128	-	-	-	-	-	RW
13282	0x33E2	Index41	0x3129	-	-	-	-	-	RW
13300	0x33F4	Index42	0x312A	-	-	-	-	-	RW
13318	0x3406	Index43	0x312B	-	-	-	-	-	RW
13336	0x3418	Index44	0x312C	-	-	-	-	-	RW
13354	0x342A	Index45	0x312D	-	-	-	-	-	RW
13372	0x343C	Index46	0x312E	-	-	-	-	-	RW
13390	0x344E	Index47	0x312F	-	-	-	-	-	RW
13408	0x3471	Index48	0x3130	-	-	-	-	-	RW
13426	0x3472	Index49	0x3131	-	-	-	-	-	RW
13444	0x3484	Index50	0x3132	-	-	-	-	-	RW
13462	0x3496	Index51	0x3133	-	-	-	-	-	RW
13480	0x34A8	Index52	0x3134	-	-	-	-	-	RW
13498	0x34BA	Index53	0x3135	-	-	-	-	-	RW
13516	0x34CC	Index54	0x3136	-	-	-	-	-	RW
13534	0x34DE	Index55	0x3137	-	-	-	-	-	RW
13552	0x34F0	Index56	0x3138	-	-	-	-	-	RW
13570	0x3502	Index57	0x3139	-	-	-	-	-	RW
13588	0x3514	Index58	0x313A	-	-	-	-	-	RW
13606	0x3526	Index59	0x313B	-	-	-	-	-	RW
13624	0x3538	Index60	0x313C	-	-	-	-	-	RW
13642	0x354A	Index61	0x313D	-	-	-	-	-	RW
13660	0x355C	Index62	0x313E	-	-	-	-	-	RW
13678	0x356E	Index63	0x313F	-	-	-	-	-	RW



### 16.4.10.1.1 Index00~Index63 Internal Variables Communication Addresses

Index00~Index63 have internal variables including IndexType, Distance, Velocity, Acceleration, Deceleration, RegDistance, RegVelocity, RepeatCount, DwellTime, Next Index and Action. Internal communication addresses take increased values based on index communication addresses.

Communication Address		Parameter Names	Variable Types	Minimum Values	Maximum Values	Units	Accessibility
Decimal Numbers	Hexadecimal Numbers						
Index	Index	Number of Entries	UINT16	-	-	-	RW
Index+1	Index+0x01	IndexType	UINT16	0	10	-	RW
Index+2	Index+0x02	Distance	INT32	-2147483648	2147483647	UU	RW
Index+4	Index+0x04	Velocity	INT32	1	2147483647	UU/s	RW
Index+6	Index+0x06	Acceleration	INT32	1	2147483647	UU/s <sup>2</sup>	RW
Index+8	Index+0x08	Deceleration	INT32	1	2147483647	UU/s <sup>2</sup>	RW
Index+10	Index+0x0A	RegDistance	INT32	-2147483648	2147483647	UU	RW
Index+12	Index+0x0C	RegVelocity	INT32	1	2147483647	UU/s <sup>2</sup>	RW
Index+14	Index+0x0E	RepeatCount	UINT16	1	65535	-	RW
Index+15	Index+0x0F	DwellTime	UINT16	0	65535	ms	RW
Index+16	Index+0x10	Next Index	UINT16	0	63	-	RW
Index+17	Index+0x11	Action	UINT16	0	2	-	RW

ex) internal variables of index 00

Communication Address		Parameter Names	Variable Types	Minimum Values	Maximum Values	Units	Accessibility
Decimal Numbers	Hexadecimal Numbers						
12544	0x3100	Number of Entries	UINT16	-	-	-	RW
12545	0x3101	IndexType	UINT16	0	10	-	RW
12546	0x3102	Distance	INT32	-2147483648	2147483647	UU	RW
12548	0x3104	Velocity	INT32	1	2147483647	UU/s	RW
12550	0x3106	Acceleration	INT32	1	2147483647	UU/s <sup>2</sup>	RW
12552	0x3108	Deceleration	INT32	1	2147483647	UU/s <sup>2</sup>	RW
12554	0x310A	RegDistance	INT32	-2147483648	2147483647	UU	RW
12556	0x310C	RegVelocity	INT32	1	2147483647	UU/s <sup>2</sup>	RW

### 16.4.10.1.2 Index00~Index63 Internal Variables Communication Addresses

Index00~Index63 have internal variables including IndexType, Distance, Velocity, Acceleration, Deceleration, RegDistance, RegVelocity, RepeatCount, DwellTime, Next Index and Action. Internal communication addresses take increased values based on index communication addresses.

Communication Address		Parameter Names	Variable Types	Minimum Values	Maximum Values	Units	Accessibility
Decimal Numbers	Hexadecimal Numbers						
Index	Index	Number of Entries	UINT16	-	-	-	RW
Index+1	Index+0x01	IndexType	UINT16	0	10	-	RW
Index+2	Index+0x02	Distance	INT32	-2147483648	2147483647	UU	RW
Index+4	Index+0x04	Velocity	INT32	1	2147483647	UU/s	RW
Index+6	Index+0x06	Acceleration	INT32	1	2147483647	UU/s <sup>2</sup>	RW
Index+8	Index+0x08	Deceleration	INT32	1	2147483647	UU/s <sup>2</sup>	RW
Index+10	Index+0x0A	RegDistance	INT32	-2147483648	2147483647	UU	RW
Index+12	Index+0x0C	RegVelocity	INT32	1	2147483647	UU/s <sup>2</sup>	RW
Index+14	Index+0x0E	RepeatCount	UINT16	1	65535	-	RW
Index+15	Index+0x0F	DwellTime	UINT16	0	65535	ms	RW
Index+16	Index+0x10	Next Index	UINT16	0	63	-	RW
Index+17	Index+0x11	Action	UINT16	0	2	-	RW

ex) internal variables of index 00

Communication Address		Parameter Names	Variable Types	Minimum Values	Maximum Values	Units	Accessibility
Decimal Numbers	Hexadecimal Numbers						
12544	0x3100	Number of Entries	UINT16	-	-	-	RW
12545	0x3101	IndexType	UINT16	0	10	-	RW
12546	0x3102	Distance	INT32	-2147483648	2147483647	UU	RW
12548	0x3104	Velocity	INT32	1	2147483647	UU/s	RW
12550	0x3106	Acceleration	INT32	1	2147483647	UU/s <sup>2</sup>	RW
12552	0x3108	Deceleration	INT32	1	2147483647	UU/s <sup>2</sup>	RW
12554	0x310A	RegDistance	INT32	-2147483648	2147483647	UU	RW
12556	0x310C	RegVelocity	INT32	1	2147483647	UU/s <sup>2</sup>	RW
12558	0x310E	RepeatCount	UINT16	1	65535	-	RW
12559	0x310F	DwellTime	UINT16	0	65535	ms	RW
12560	0x3110	Next Index	UINT16	0	63	-	RW
12561	0x3111	Action	UINT16	0	2	-	RW

## 17. Test Drive

For a safe and proper test drive, make sure to check the following prior to a test drive. If there is a problem, take appropriate measures before the test drive.

### ■ Servo Motor State

Is the motor correctly installed and wired?

Is each connecting part correctly tightened without looseness?

For motors with oil seal, is there any damage on the oil seal?

Is oil properly applied?

To perform a test drive of a servo motor that has been stored for an extended period, make sure to check the motor according to the maintenance and inspection method for the motor. For more information on maintenance and inspection, refer to Section 14. "Maintenance and Inspection."

### ■ Servo Drive State

Is the drive correctly installed, wired and connected?

Is the power supply voltage for the servo drive correct?

## 17.1 Preparation for Operation

Carry out a test drive in the following order.

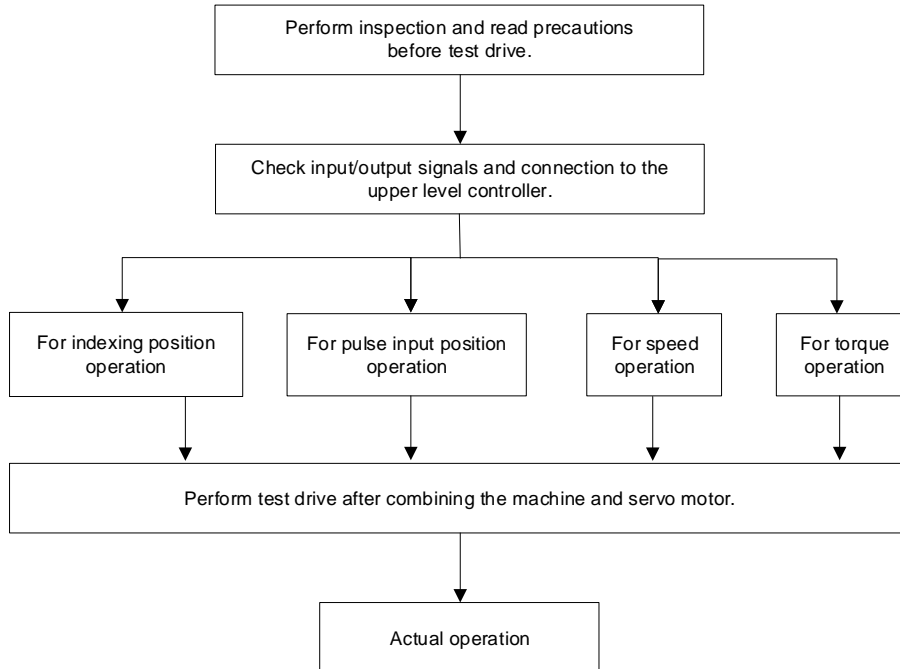

Before a test drive, make sure that wiring between the upper device and servo drive as well as the parameter settings of the servo drive are proper.

To use a Quadrature (Incremental) type motor or another company's motor, set parameter motor ID [0x2000], encoder type [0x2001], encoder pulse count per revolution [0x2002] and position error range [0x301D] before the test drive.

## 17.1.1 Indexing Position Operation

Order	Handling	Notes
1	Re-check the power and the input signal circuit and turn on the control power of the servo drive.	
2	Set the value of Index 00~Index 63 for the index to operate.	3.2 Indexing Position Operation
3	For safety, enter a 1/10 of the intended value for Velocity and Registration Velocity.	
4	Set electric gear ratio according to the upper device. When using the electric gear and the STOP signal at the same time, adjust the value of Quick Stop Deceleration [0x3024].	10.3 Electric Gear Setup 15.4.10 Index Related Parameters
5	Turn on the main circuit power of the servo drive.	
6	Turn on the SVON input signal.	
7	Switch the START input signal from ON->OFF.	
8	Check if the Distance and Registration Distance values set through the [0x2629] position demand value are displayed.	
9	Check the actual motor revolution count through the [0x262A] actual position value.	
10	Check if the servo motor has performed index operation in the requested direction.	
11	Turn off the SVON input signal, change Velocity and Registration Velocity to intended values and re-perform order 6 to order 11.	
12	Turn off the SVON input signal.	
13		

### Inspection Objects Before Test Drive

Index	Sub Index	Names	Variable Types	Accessibility	PDO Assignment	Unit
0x2000	-	Motor ID	UINT	RW	No	-
0x2001	-	Encoder Type	UINT	RW	No	-
0x2002	-	Encoder Pulse per Revolution	UDINT	RW	No	pulse
0x2003	-	Node ID	UINT	RO	No	-
0x2004	-	Rotation Direction Select	UINT	RW	No	-
0x2013	-	Emergency Stop Configuration	UINT	RW	No	-
0x2110	-	Torque Limit Function Select	UINT	RW	No	-

0x2111	-	External Positive Torque Limit Value	UINT	RW	No	-
0x2112	-	External Negative Torque Limit Value	UINT	RW	No	-
0x2113	-	Emergency Stop Torque	UINT	RW	No	0.1%
0x211F	-	Drive Control Input 1	UINT	RW	No	-
0x2120	-	Drive Control Input 2	UINT	RW	No	-
0x2121	-	Drive Status Output 1	UINT	RW	No	-
0x2121	-	Drive Status Output 2	UINT	RW	No	-
0x2200	-	Digital Input Signal 1 Selection	UINT	RW	No	-
0x2201	-	Digital Input Signal 2 Selection	UINT	RW	No	-
0x2202	-	Digital Input Signal 3 Selection	UINT	RW	No	-
0x2203	-	Digital Input Signal 4 Selection	UINT	RW	No	-
0x2204	-	Digital Input Signal 5 Selection	UINT	RW	No	-
0x2205	-	Digital Input Signal 6 Selection	UINT	RW	No	-
0x2206	-	Digital Input Signal 7 Selection	UINT	RW	No	-
0x2207	-	Digital Input Signal 8 Selection	UINT	RW	No	-
0x2208	-	Digital Input Signal 9 Selection	UINT	RW	No	-
0x2209	-	Digital Input Signal 10 Selection	UINT	RW	No	-
0x220A	-	Digital Output Signal 1 Selection	UINT	RW	No	-
0x220B	-	Digital Output Signal 2 Selection	UINT	RW	No	-
0x220C	-	Digital Output Signal 3 Selection	UINT	RW	No	-
0x220D	-	Digital Output Signal 4 Selection	UINT	RW	No	-
0x220E	-	Digital Output Signal 5 Selection	UINT	RW	No	-
0x2210	-	Analog Torque Input (command/limit) Scale	UINT	RW	No	0.1%/V
0x2211	-	Analog Torque Input (command/limit) Offset	INT	RW	No	mV
0x220F	-	Analog Velocity Override Mode	UINT	RW	No	-
0x2215	-	Analog Velocity Input (command/override) Offset	INT	RW	No	mV
0x240C	-	Modulo Factor	DINT	RW	No	-
0x3000	-	Control Mode	UINT	RW	No	-
0x3001	-	Coordinate Select	UINT	RW	No	-
0x3002	-	Baud Rate Select	UINT	RW	No	-
0x3006	-	Encoder Output Pulse	UDINT	RW	No	Pulse
-	-	-	-	-	-	-
0x3008	-	Start Index Number (0~63)	UINT	RW	No	-

0x3009	-	Index Buffer Mode	UINT	RW	No	-
0x300A	-	IO Signal Configuration	UINT	RW	No	-

Index	Sub Index	Names	Variable Types	Accessibility	PDO Assignment	Unit
0x3100	-	Index 00	-	-	-	-
	0	Number of Entries	USINT	RO	No	-
	1	Index Type	UINT	RW	No	-
	2	Distance	DINT	RW	No	UU
	3	Velocity	DINT	RW	No	UU/s
	4	Acceleration	DINT	RW	No	UU/s <sup>2</sup>
	5	Deceleration	DINT	RW	No	UU/s <sup>2</sup>
	6	Registration Distance	DINT	RW	No	UU
	7	Registration Velocity	DINT	RW	No	UU/s
	8	Repeat Count	UINT	RW	No	-
	9	Dwell Time	UINT	RW	No	ms
	10	Next Index	UINT	RW	No	-
11	Action	UINT	RW	No	-	
0x3101	-	Index01	-	-	-	-
~						
0x313F	-	Index 63	-	-	-	-

## 17.1.2 Pulse Input Position Operation

### ■ Test Drive Procedure

Order	Handling	Notes
1	Re-check the power and the input signal circuit and turn on the control power of the servo drive.	
2	Set the logic of [0x3003] input pulse according to the pulse output format of the upper device.	5.1 Pulse Input Logic Function Setting
3	Set the command unit, then set the electric gear ratio according to the upper device. When using the electric gear and the STOP signal at the same time, adjust the value of Quick Stop Deceleration [0x3024].	10.3 Electric Gear Setup 15.4.10 Index Related Parameters
4	Turn on the main circuit power of the servo drive.	
5	Turn on the SVON input signal.	
6	Output low-speed pulse commands at motor revolution counts that are easily identifiable. For safety, set the motor speed to 100[rpm] or below for the command pulse velocity.	
7	Check the command pulse count input through the [0x2629] position demand values.	
8	Check the actual motor revolution count through the [0x262A] actual position value.	
9	Check if the servo motor has performed index operation in the requested direction.	
10	Output pulse commands from the upper device at the speed requested by the device.	
11	Check the velocity, position demand value and actual position value of the servo motor.	
12	Pause the pulse commands and turn off the SVON input signal.	
13		



■ Inspection Objects Before Test Drive

Index	Sub Index	Names	Variable Types	Accessability	PDO Assignment	Unit
0x2000	-	Motor ID	UINT	RW	No	-
0x2001	-	Encoder Type	UINT	RW	No	-
0x2002	-	Encoder Pulse per Revolution	UDINT	RW	No	pulse
0x2003	-	Node ID	UINT	RO	No	-
0x2004	-	Rotation Direction Select	UINT	RW	No	-
0x2013	-	Emergency Stop Configuration	UINT	RW	No	-
0x2110	-	Torque Limit Function Select	UINT	RW	No	-
0x2111	-	External Positive Torque Limit Value	UINT	RW	No	-
0x2112	-	External Negative Torque Limit Value	UINT	RW	No	-
0x2113	-	Emergency Stop Torque	UINT	RW	No	0.1%
0x211F	-	Drive Control Input 1	UINT	RW	No	-
0x2120	-	Drive Control Input 2	UINT	RW	No	-
0x2121	-	Drive Status Output 1	UINT	RW	No	-
0x2121	-	Drive Status Output 2	UINT	RW	No	-
0x2200	-	Digital Input Signal 1 Selection	UINT	RW	No	-
0x2201	-	Digital Input Signal 2 Selection	UINT	RW	No	-
0x2202	-	Digital Input Signal 3 Selection	UINT	RW	No	-
0x2203	-	Digital Input Signal 4 Selection	UINT	RW	No	-
0x2204	-	Digital Input Signal 5 Selection	UINT	RW	No	-
0x2205	-	Digital Input Signal 6 Selection	UINT	RW	No	-

0x2206	-	Digital Input Signal 7 Selection	UINT	RW	No	-
0x2207	-	Digital Input Signal 8 Selection	UINT	RW	No	-
0x2208	-	Digital Input Signal 9 Selection	UINT	RW	No	-
0x2209	-	Digital Input Signal 10 Selection	UINT	RW	No	-
0x220A	-	Digital Input Signal 10 Selection	UINT	RW	No	-
0x220B	-	Digital Output Signal 1 Selection	UINT	RW	No	-
0x220C	-	Digital Output Signal 2 Selection	UINT	RW	No	-

Index	Sub Index	Names	Variable Types	Accessability	PDO Assignment	Unit
0x220D	-	Digital Output Signal 3 Selection	UINT	RW	No	-
0x220E	-	Digital Output Signal 4 Selection	UINT	RW	No	-
0x220F	-	Digital Output Signal 5 Selection	UINT	RW	No	-
0x3000	-	Control Mode	UINT	RW	No	-
0x3001	-	Coordinate Select	UINT	RW	No	-
0x3002	-	Baud Rate Select	UINT	RW	No	-
0x3003	-	Pulse Input Logic Select	UINT	RW	No	-
0x3004	-	Pulse Input Filter Select	UINT	RW	No	-
0x3005	-	PCLEAR Mode Select	UINT	RW	No	-
0x3006	-	Encoder Output Pulse	UDINT	RW	No	Pulse
-	-	-	-	-	-	-

## 17.1.3 Velocity Mode

### ■ Test Drive Procedure

Order	Handling	Notes
1	Re-check the power and the input signal circuit and turn on the control power of the servo drive.	
2	Set the [0x231A] velocity command switch select function according to the control method.	13.3 Manufacturer Specific Objects.
3	Set the parameters for multi-step operation velocity and digital input signal setting for control using digital input signals. Set parameters for [0x2229] analog velocity command scale and [0x222A] analog velocity command clamp level for analog velocity operation. Set the value to 1/10 of the actual operation value.	
4	Turn on the main circuit power of the servo drive.	
5	Turn on the SVON input signal.	
6	Give a command signal to the servo drive and compare the actual operation velocity and the command speed.	
7	Check if the servo motor has performed index operation in the requested direction.	
8	Output from the upper device at the speed requested by the device.	
9	Check the velocity of the servo motor.	
10	Pause the commands and turn off the SVON input signal.	

### ■ Inspection Objects Before Test Drive

Index	Sub Index	Names	Variable Types	Access ibility	PDO Assignment	Unit
0x2000	-	Motor ID	UINT	RW	No	-
0x2001	-	Encoder Type	UINT	RW	No	-
0x2002	-	Encoder Pulse per Revolution	UDINT	RW	No	pulse
0x2003	-	Node ID	UINT	RO	No	-
0x2004	-	Rotation Direction Select	UINT	RW	No	-
0x2013	-	Emergency Stop Configuration	UINT	RW	No	-
0x2110	-	Torque Limit Function Select	UINT	RW	No	-
0x2111	-	External Positive Torque Limit Value	UINT	RW	No	-

0x2112	-	External Negative Torque Limit Value	UINT	RW	No	-
0x2113	-	Emergency Stop Torque	UINT	RW	No	0.1%
0x211F	-	Drive Control Input 1	UINT	RW	No	-
0x2120	-	Drive Control Input 2	UINT	RW	No	-
0x2121	-	Drive Status Output 1	UINT	RW	No	-
0x2121	-	Drive Status Output 2	UINT	RW	No	-
0x2200	-	Digital Input Signal 1 Selection	UINT	RW	No	-
0x2201	-	Digital Input Signal 2 Selection	UINT	RW	No	-
0x2202	-	Digital Input Signal 3 Selection	UINT	RW	No	-
0x2203	-	Digital Input Signal 4 Selection	UINT	RW	No	-
0x2204	-	Digital Input Signal 5 Selection	UINT	RW	No	-
0x2205	-	Digital Input Signal 6 Selection	UINT	RW	No	-
0x2206	-	Digital Input Signal 7 Selection	UINT	RW	No	-
0x2207	-	Digital Input Signal 8 Selection	UINT	RW	No	-
0x2208	-	Digital Input Signal 9 Selection	UINT	RW	No	-
0x2209	-	Digital Input Signal 10 Selection	UINT	RW	No	-
0x220A	-	Digital Output Signal 1 Selection	UINT	RW	No	-
0x220B	-	Digital Output Signal 2 Selection	UINT	RW	No	-
0x220C	-	Digital Output Signal 3 Selection	UINT	RW	No	-
0x220D	-	Digital Output Signal 4 Selection	UINT	RW	No	-
0x220E	-	Digital Output Signal 5 Selection	UINT	RW	No	-
0x2210	-	Analog Torque Input (command/limit) Scale	UINT	RW	No	0.1%/V

0x2211	-	Analog Torque Input (command/limit) Offset	INT	RW	No	mV
0x220F	-	Analog Velocity Override Mode	UINT	RW	No	-
0x2215	-	Analog Velocity Input (command/override) Offset	INT	RW	No	mV
0x2227	-	Analog Velocity Command Filter Time Constant	UINT	RW	No	0.1ms
0x222A	-	Analog Velocity Command Clamp Level	UINT	RW	No	rpm
0x2301	-	Speed Command Acceleration Time	UINT	RW	No	ms
0x2302	-	Speed Command Deceleration Time	UINT	RW	No	ms
0x2303	-	Speed Command S-curve Time	UINT	RW	No	ms
0x230D	-	Speed Limit Function Select	UINT	RW	No	-
0x2312	-	Multi-Step Operation Velocity 1	INT	RW	No	rpm
0x2313	-	Multi-Step Operation Velocity 2	INT	RW	No	rpm
0x2314	-	Multi-Step Operation Velocity 3	INT	RW	No	rpm
0x2316	-	Multi-Step Operation Velocity 5	INT	RW	No	rpm
0x2317	-	Multi-Step Operation Velocity 6	INT	RW	No	rpm
0x2318	-	Multi-Step Operation Velocity 7	INT	RW	No	rpm
0x2319	-	Multi-Step Operation Velocity 8	INT	RW	No	rpm
0x231A	-	Velocity Command Switch Select	UINT	RW	No	-
0x3000	-	Control Mode	UINT	RW	No	-
0x3002	-	Baud Rate Select	UINT	RW	No	-
0x3006	-	Encoder Output Pulse	UDINT	RW	No	Pulse
-	-	-	-	-	-	-

## 17.1.4 Torque Operation

### ■ Test Drive Procedure

Order	Handling	Notes
1	Re-check the power and the input signal circuit and turn on the control power of the servo drive.	
2	Set the [0x2210] analog torque command scale.	
3	Set the speed limit value at [0x230E] torque control. Set the value to 1/10 of the actual operation value.	
4	Turn on the main circuit power of the servo drive.	
5	Turn on the SVON input signal.	
6	Apply analog voltage to the servo drive and check the velocity and command torque.	
7	Check if the servo motor has performed index operation in the requested direction.	
8	Output from the upper device at the speed requested by the device.	
9	Check the velocity and command torque value of the servo motor.	
10	Pause the commands and turn off the SVON input signal.	

### ■ Inspection Objects Before Test Drive

Index	Sub Index	Name	Variable Type	Accessability	PDO Assignment	Unit
0x2000	-	Motor ID	UINT	RW	No	-
0x2001	-	Encoder Type	UINT	RW	No	-
0x2002	-	Encoder Pulse per Revolution	UDINT	RW	No	pulse
0x2003	-	Node ID	UINT	RO	No	-
0x2004	-	Rotation Direction Select	UINT	RW	No	-
0x2013	-	Emergency Stop Configuration	UINT	RW	No	-
0x2110	Index-	Torque Limit Function Select	UINT	RW	No	-
0x2111	Index-	External Positive Torque Limit Value	UINT	RW	No	-
0x2112	Index-	External Negative Torque Limit Value	UINT	RW	No	-
0x2113	Index-	Emergency Stop Torque	UINT	RW	No	0.1%
0x211F	-	Drive Control Input 1	UINT	RW	No	-
0x2120	-	Drive Control Input 2	UINT	RW	No	-
0x2121	-	Drive Status Output 1	UINT	RW	No	-
0x2121	-	Drive Status Output 2	UINT	RW	No	-
0x2200	-	Digital Input Signal 1 Selection	UINT	RW	No	-
0x2201	-	Digital Input Signal 2 Selection	UINT	RW	No	-
0x2202	-	Digital Input Signal 3 Selection	UINT	RW	No	-
0x2203	-	Digital Input Signal 4 Selection	UINT	RW	No	-
0x2204	-	Digital Input Signal 5 Selection	UINT	RW	No	-
0x2205	-	Digital Input Signal 6 Selection	UINT	RW	No	-

0x2206	-	Digital Input Signal 7 Selection	UINT	RW	No	-
0x2207	-	Digital Input Signal 8 Selection	UINT	RW	No	-
0x2208	-	Digital Input Signal 9 Selection	UINT	RW	No	-
0x2209	-	Digital Input Signal 10 Selection	UINT	RW	No	-
0x220A	-	Digital Output Signal 1 Selection	UINT	RW	No	-
0x220B	-	Digital Output Signal 2 Selection	UINT	RW	No	-
0x220C	-	Digital Output Signal 3 Selection	UINT	RW	No	-
0x220D	-	Digital Output Signal 4 Selection	UINT	RW	No	-
0x220E	-	Digital Output Signal 5 Selection	UINT	RW	No	-
0x2210	-	Analog Torque Input (command/limit) Scale	UINT	RW	No	0.1%/V
0x2211	-	Analog Torque Input (command/limit) Offset	INT	RW	No	mV
0x2228	-	Analog Torque Command Filter Time Constant	UINT	RW	No	0.1ms
0x2301	-	Speed Command Acceleration Time	UINT	RW	No	ms
0x2302	-	Speed Command Deceleration Time	UINT	RW	No	ms
0x2228	-	Analog Torque Command Filter Time Constant	UINT	RW	No	0.1ms
0x230E	-	Velocity Limit Value at Torque Control Mode	UINT	RW	No	-
0x3000	-	Control Mode	UINT	RW	No	-
0x3002	-	Baud Rate Select	UINT	RW	No	-
0x3006	-	Encoder Output Pulse	UDINT	RW	No	Pulse
-	-	-	-	-	-	-



# 18. Appendix

## 18.1 Firmware Update

### 18.1.1 Using Drive CM

Drive CM allows you to upgrade the OS for the drive to the newest through the PC's USB port. The transmission time depends on the PC performance, but it usually takes from tens of seconds to several minutes.



From the top menu, select the "Setup"->"FIRMWARE UPGRADE"→"OS Download" buttons.

#### ■ Precautions for Firmware Upgrade

- Do not turn off the PC or drive during transmission.
- Do not unplug the USB cable or close the firmware program during transmission.
- Do not run other applications on the PC during transmission.
- Since the parameter (object) setting values in the drive may be reset, save the drive parameter (object) setting values before upgrade.

## ■ Firmware Download

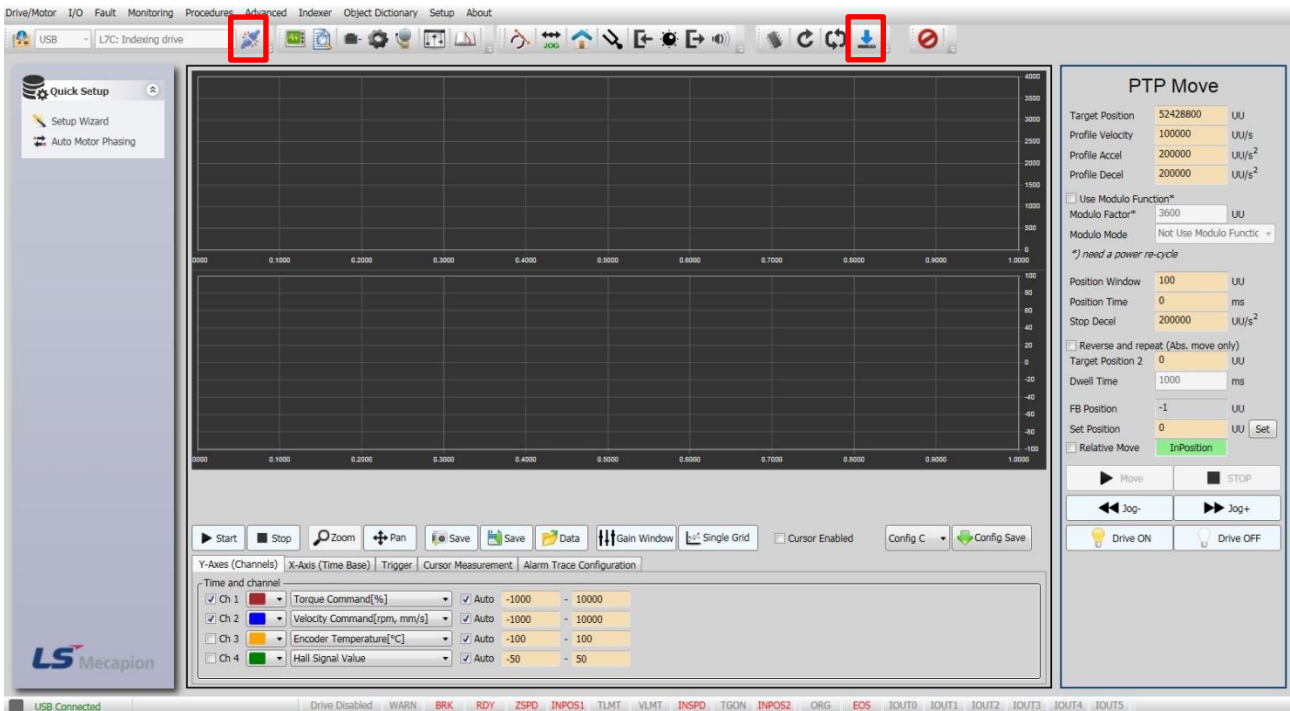

- (1) Connect DriveCM.
- (2) Click "Firmware Update" on the top-right corner of Drive CM.

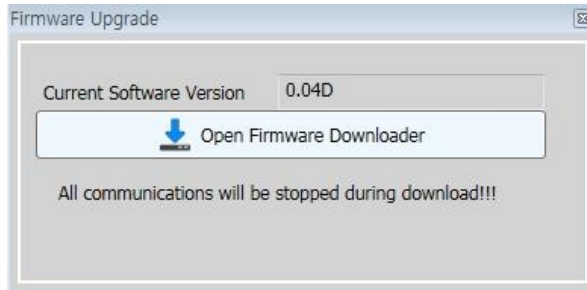

- (3) An upgrade pop-up window is generated and the applied version of the servo is displayed.
- (4) Click the "Open Firmware Downloader" button.

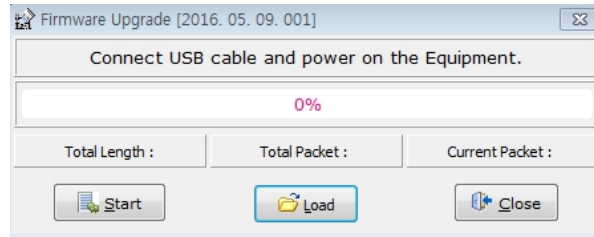

- (5) An upgrade window is generated.
- (6) To load the appropriate firmware file, click the "Load" button.

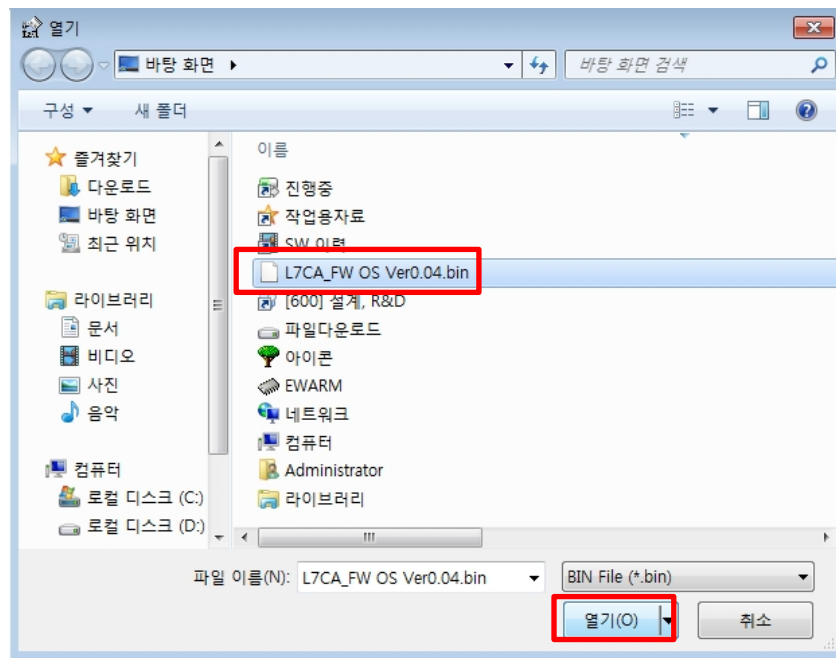

- (7) Select the BIN file of the firmware to transmit and press the Open button.

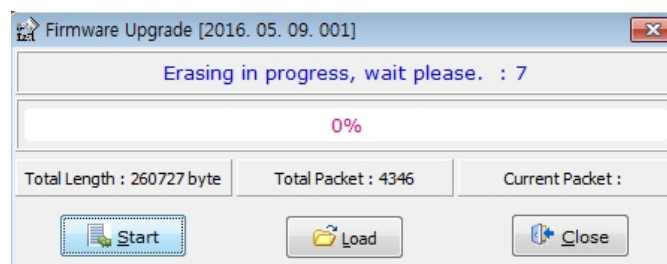

- (8) "Total Length" and "Total Packet" of the loaded firmware are displayed.

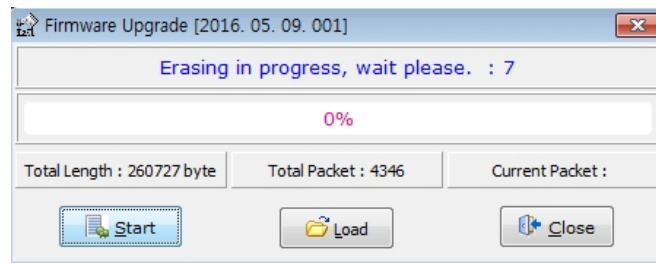

- (9) Press the "Start" button to start transmission. A count-down of 10 seconds is activated to clear the internal memory in the drive. (Here, "Flash" is displayed for 7 segments for L7C.)

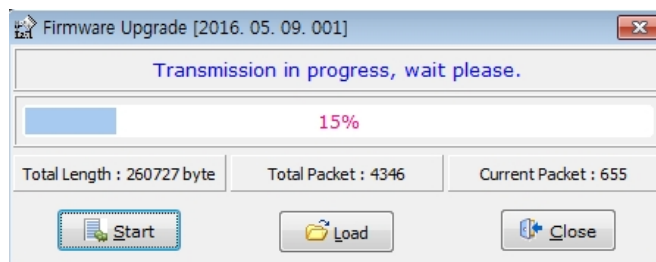

- (10) After clearing, the firmware is transmitted automatically and the progress bar and "Current Packet" display the current transmission status. (The transmission time depends on the PC performance, but it usually takes from tens of seconds to several minutes.)

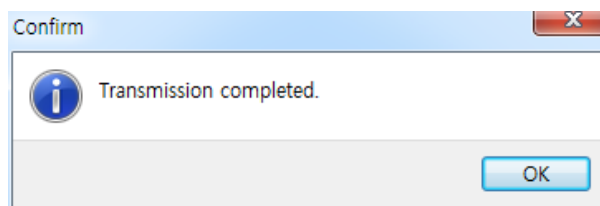

- (11) When the transmission is completed, a pop-up saying "Transmission completed" is displayed.
- (12) After completion of PC transmission, make sure to reboot the drive by turning off and on the power of the drive.

In L7C, if you turn on the power again after Main Power Fail Check Time[0x2007] + 1.0[sec](approx. 1[Sec]), an auto update is performed. You can view the update progress details on the segment window.

## ■ When an Error Occurs During Transmission

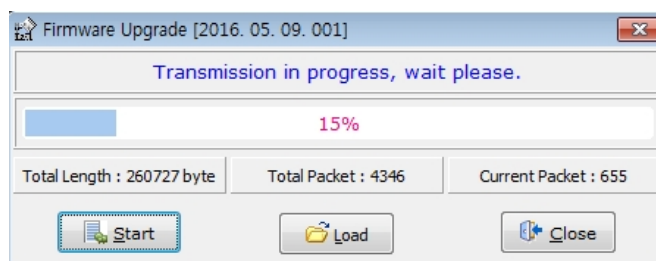

- (1) If the download cable is pulled off during servo firmware update, the update may be stopped.

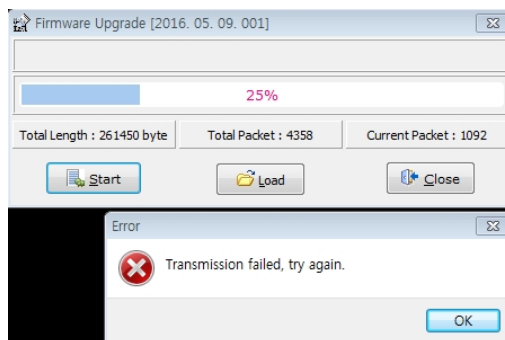

- (2) Turn off and on the drive power and repeat the above process from (2) to (12).

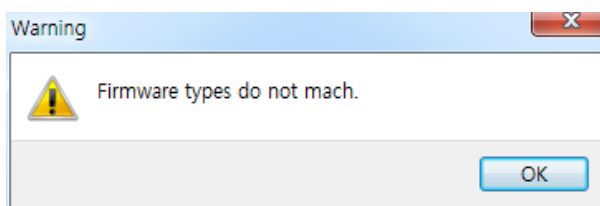

- (3) If the above pop-up appears,  
check the drive type.

## 18.2 Summary of Parameters

### ■ Basic Setting (0x2000~)

Parameter Numbers	Parameter Names	Initial Values	Variable Types	Accessibility	Units	Minimum Values	Maximum Values	Variable Attribute
0x2000	Motor ID	13	UINT	RW	-	1	9999	Power re-input
0x2001	Encoder Type	1	UINT	RW	-	0	2	Power re-input
0x2002	Encoder Pulse per Revolution	524288	UDINT	RW	pulse	0	1073741824	Power re-input
0x2003	Node ID	1	UINT	RW	-	1	99	Power re-input
0x2004	Rotation Direction Select	0	UINT	RW	-	0	1	Power re-input
0x2005	Absolute Encoder Configuration	1	UINT	RW	-	0	2	Power re-input
0x2006	Main Power Fail Check Mode	0	UINT	RW	ms	0	255	Always
0x2007	Main Power Fail Check Time	20	UINT	RW	ms	0	5000	Always
0x2008	7SEG Display Selection	0	UINT	RW	-	0	100	Always
0x2009	Regeneration Brake Resistor Configuration	0	UINT	RW	-	0	1	Always
0x200A	Regeneration Brake Resistor Derating Factor	100	UINT	RW	%	0	200	Always
0x200B	Regeneration Brake Resistor Value	0	UINT	RW	ohm	0	1000	Always
0x200C	Regeneration Brake Resistor Power	0	UINT	RW	watt	0	30000	Always
0x200D	Peak Power of Regeneration Brake Resistor	100	UINT	RW	watt	1	50000	Always
0x200E	Duration Time @ Peak Power of Regeneration Brake Resistor	5000	UINT	RW	ms	1	50000	Always
0x200F	Overload Check Base	100	UINT	RW	%	10	120	Always
0x2010	Overload Warning Level	50	UINT	RW	%	10	100	Always
0x2011	PWM Off Delay Time	10	UINT	RW	ms	0	1000	Always
0x2012	Dynamic Brake Control Mode	0	UINT	RW	-	0	3	Always
0x2013	Emergency Stop Configuration	1	UINT	RW	-	0	1	Always
0x2014	Warning Mask Configuration	0	UINT	RW	-	0	0xFFFF	Always
0x2015	U Phase Current Offset	0	INT	RW	0.10%	-1000	1000	Always
0x2016	V Phase Current Offset	0	INT	RW	0.10%	-1000	1000	Always
0x2017	W Phase Current Offset	0	INT	RW	0.10%	-1000	1000	Always
0x2018	Magnetic Pole Pitch	2400	UINT	RW	0.01mm	1	65535	Power re-input
0x2019	Linear Scale Resolution	1000	UINT	RW	nm	1	65535	Power re-input
0x201A	Commutation Method	0	UINT	RW	-	0	4	Power re-input

0x201B	Commutation Current	500	UINT	RW	0.10%	0	1000	Always
0x201C	Commutation Time	1000	UINT	RW	ms	500	5000	Always
0x201D	Grating Period of Sinusoidal Encoder	40	UINT	RW	Um	1	65535	Power re-input
0x201E	Homing Done Behavior	0	UINT	RW	-	0	1	Always
0x201F	Velocity Function Select	0	UINT	RW	-	0	2	Always
0x2020	Motor Hall Phase Config.	0	UINT	RW	-	0	65535	Power re-input

#### ■ Gain Adjustment (0x2100~)

Parameter Numbers	Parameter Names	Initial Values	Variable Types	Accessibility	Units	Minimum Values	Maximum Values	Notes
0x2100	Inertia Ratio	100	UINT	RW	%	0	3000	Always
0x2101	Position Loop Gain 1	50	UINT	RW	1/s	1	500	Always
0x2102	Speed Loop Gain 1	75	UINT	RW	Hz	1	2000	Always
0x2103	Speed Loop Integral Time Constant 1	50	UINT	RW	ms	1	1000	Always
0x2104	Torque Command Filter Time Constant 1	5	UINT	RW	0.1ms	0	1000	Always
0x2105	Position Loop Gain 2	30	UINT	RW	1/s	1	500	Always
0x2106	Speed Loop Gain 2	50	UINT	RW	Hz	1	2000	Always
0x2107	Speed Loop Integral Time Constant 2	50	UINT	RW	ms	1	1000	Always
0x2108	Torque Command Filter Time Constant 2	5	UINT	RW	0.1ms	0	1000	Always
0x2109	Position Command Filter Time Constant	0	UINT	RW	0.1ms	0	10000	Always
0x210A	Position Command Average Filter Time Constant	0	UINT	RW	0.1ms	0	10000	Always
0x210B	Speed Feedback Filter Time Constant	5	UINT	RW	0.1ms	0	10000	Always
0x210C	Velocity Feed-forward Gain	0	UINT	RW	%	0	100	Always
0x210D	Velocity Feed-forward Filter Time Constant	10	UINT	RW	0.1ms	0	1000	Always
0x210E	Torque Feed-forward Gain	0	UINT	RW	%	0	100	Always
0x210F	Torque Feed-forward Filter Time Constant	10	UINT	RW	0.1ms	0	1000	Always
0x2110	Torque Limit Function Select	2	UINT	RW	-	0	4	Always
0x2111	External Positive Torque Limit Value	3000	UINT	RW	0.1%	0	5000	Always
0x2112	External Negative Torque Limit Value	3000	UINT	RW	0.1%	0	5000	Always
0x2113	Emergency Stop Torque	1000	UINT	RW	0.1%	0	5000	Always
0x2114	P/PI Control Conversion Mode	0	UINT	RW	-	0	4	Always
0x2115	P Control Switch Torque	500	UINT	RW	0.1%	0	5000	Always
0x2116	P Control Switch Speed	100	UINT	RW	rpm	0	6000	Always
0x2117	P Control Switch Acceleration	1000	UINT	RW	rpm/s	0	60000	Always
0x2118	P Control Switch Following Error	100	UINT	RW	pulse	0	60000	Always

0x2119	Gain Conversion Mode	0	UINT	RW	-	0	7	Always
0x211A	Gain Conversion Time 1	2	UINT	RW	ms	0	1000	Always
0x211B	Gain Conversion Time 2	2	UINT	RW	ms	0	1000	Always
0x211C	Gain Conversion Waiting Time 1	0	UINT	RW	ms	0	1000	Always
0x211D	Gain Conversion Waiting Time 2	0	UINT	RW	ms	0	1000	Always
0x211E	Dead Band for Position Control	0	UINT	RW	UU	0	1000	Always
0x211F	Drive Control Input 1	0	UINT	RW	-	0	0xFFFF	-
0x2120	Drive Control Input 2	0	UINT	RW	-	0	0xFFFF	-
0x2121	Drive Status Output 1	0	UINT	RO	-	0	0xFFFF	-
0x2122	Drive Status Output 2	0	UINT	RO	-	0	0xFFFF	-

#### ■ I/O Configuration (0x2200~)

Parameter Numbers	Parameter Names	Initial Values	Variable Types	Accessibility	Units	Minimum Values	Maximum Values	Notes
0x2200	Digital Input Signal 1 Selection	0x000F	UINT	RW	-	0	0xFFFF	Always
0x2201	Digital Input Signal 2 Selection	0x0020	UINT	RW	-	0	0xFFFF	Always
0x2202	Digital Input Signal 3 Selection	0x0021	UINT	RW	-	0	0xFFFF	Always
0x2203	Digital Input Signal 4 Selection	0x0022	UINT	RW	-	0	0xFFFF	Always
0x2204	Digital Input Signal 5 Selection	0x000C	UINT	RW	-	0	0xFFFF	Always
0x2205	Digital Input Signal 6 Selection	0x001C	UINT	RW	-	0	0xFFFF	Always
0x2206	Digital Input Signal 7 Selection	0x0001	UINT	RW	-	0	0xFFFF	Always
0x2207	Digital Input Signal 8 Selection	0x0002	UINT	RW	-	0	0xFFFF	Always
0x2208	Digital Input Signal 9 Selection	0x000B	UINT	RW	-	0	0xFFFF	Always
0x2209	Digital Input Signal 10 Selection	0x0004	UINT	RW	-	0	0xFFFF	Always
0x220A	Digital Output Signal 1 Selection	0x8002	UINT	RW	-	0	0xFFFF	Always
0x220B	Digital Output Signal 2 Selection	0x0003	UINT	RW	-	0	0xFFFF	Always
0x220C	Digital Output Signal 3 Selection	0x0004	UINT	RW	-	0	0xFFFF	Always
0x220D	Digital Output Signal 4 Selection	0x8001	UINT	RW	-	0	0xFFFF	Always
0x220E	Digital Output Signal 5 Selection	0x0005	UINT	RW	-	0	0xFFFF	Always
0x220F	Analog Velocity Override Mode	0	UINT	RW	-	0	2	Always
0x2210	Analog Torque Input (command/limit) Scale	100	UINT	RW	0.1%/V	-1000	1000	Always
0x2211	Analog Torque Input (command/limit) Offset	0	INT	RW	mV	-1000	1000	Always
0x2212	Analog Torque Command Clamp Level	0	UINT	RW	Rpm	0	1000	Always
0x2213	Analog Torque Command Filter Time Constant	2	UINT	RW	0.1ms	0	1000	Always
0x2214	Analog Velocity Command Scale	100	INT	RW	rpm/V	-1000	1000	Always
0x2215	Analog Velocity Input (command/override) Offset	0	INT	RW	mV	-1000	1000	Always
0x2216	Analog Velocity Command Clamp Level	0	UINT	RW	Rpm	0	1000	Always



0x2217	Analog Velocity Command Filter Time Constant	2	UINT	RW	0.1ms	0	1000	Always
--------	--	---	------	----	-------	---	------	--------

#### ■ Velocity Control (0x2300~)

Parameter Numbers	Parameter Names	Initial Values	Variable Types	Accessibility	Units	Minimum Values	Maximum Values	Notes
0x2300	Jog Operation Speed	500	INT	RW	rpm	-6000	6000	Always
0x2301	Speed Command Acceleration Time	200	UINT	RW	ms	0	10000	Always
0x2302	Speed Command Deceleration Time	200	UINT	RW	ms	0	10000	Always
0x2303	Speed Command S-curve Time	0	UINT	RW	ms	0	1000	Always
0x2304	Program Jog Operation Speed 1	0	INT	RW	rpm	-6000	6000	Always
0x2305	Program Jog Operation Speed 2	500	INT	RW	rpm	-6000	6000	Always
0x2306	Program Jog Operation Speed 3	0	INT	RW	rpm	-6000	6000	Always
0x2307	Program Jog Operation Speed 4	-500	INT	RW	rpm	-6000	6000	Always
0x2308	Program Jog Operation Time 1	500	UINT	RW	ms	0	10000	Always
0x2309	Program Jog Operation Time 2	5000	UINT	RW	ms	0	10000	Always
0x230A	Program Jog Operation Time 3	500	UINT	RW	ms	0	10000	Always
0x230B	Program Jog Operation Time 4	5000	UINT	RW	ms	0	10000	Always
0x230C	Index Pulse Search Speed	20	INT	RW	rpm	-1000	1000	Always
0x230D	Speed Limit Function Select	0	UINT	RW	-	0	3	Always
0x230E	Velocity Limit Value at Torque Control Mode	1000	UINT	RW	rpm	0	6000	Always
0x230F	Over Speed Detection Level	6000	UINT	RW	rpm	0	10000	Always
0x2310	Excessive Speed Error Detection Level	5000	UINT	RW	rpm	0	10000	Always
0x2311	Servo-Lock Function Select	0	UINT	RW	-	0	1	Always
0x2312	Multi-Step Operation Velocity 1	0	INT	RW	rpm	-6000	6000	Always
0x2313	Multi-Step Operation Velocity 2	10	INT	RW	rpm	-6000	6000	Always
0x2314	Multi-Step Operation Velocity 3	50	INT	RW	rpm	-6000	6000	Always
0x2315	Multi-Step Operation Velocity 4	100	INT	RW	rpm	-6000	6000	Always
0x2316	Multi-Step Operation Velocity 5	200	INT	RW	rpm	-6000	6000	Always
0x2317	Multi-Step Operation Velocity 6	500	INT	RW	rpm	-6000	6000	Always
0x2318	Multi-Step Operation Velocity 7	1000	INT	RW	rpm	-6000	6000	Always
0x2319	Multi-Step Operation Velocity 8	1500	INT	RW	rpm	-6000	6000	Always
0x231A	Velocity Command Switch Select	0	UINT	RW	-	0	3	Always

### ■ Miscellaneous Setting (0x2400~)

Parameter Numbers	Parameter Names	Initial Values	Variable Types	Accessibility	Units	Minimum Values	Maximum Values	Notes
0x2400	Software Position Limit Function Select	0	UINT	RW	-	0	3	Always
0x2401	INPOS1 Output Range	100	UINT	RW	UU	0	60000	Always
0x2402	INPOS1 Output Time	0	UINT	RW	ms	0	1000	Always
0x2403	INPOS2 Output Range	100	UINT	RW	UU	0	60000	Always
0x2404	ZSPD Output Range	10	UINT	RW	rpm	0	6000	Always
0x2405	TGON Output Range	100	UINT	RW	rpm	0	6000	Always
0x2406	INSPD Output Range	100	UINT	RW	rpm	0	6000	Always
0x2407	BRAKE Output Speed	100	UINT	RW	rpm	0	6000	Always
0x2408	BRAKE Output Delay Time	100	UINT	RW	ms	0	1000	Always
0x2409	Torque Limit at Homing Using Stopper	250	UINT	RW	0.10%	0	2000	Always
0x240A	Duration Time at Homing Using Stopper	50	UINT	RW	ms	0	1000	Always
0x240B	Modulo Mode	0	UINT	RW	-	0	5	Always
0x240C	Modulo Factor	3600	DINT	RW	UU	1	1073741823	Power re-input
0x240D	User Drive Name	Drive	STRING	RW	-			Always
0x240E	Individual Parameter Save	0	UINT	RW	-	0	1	Always
0x240F	RMS Overload Calculation Time	15000	UINT	RW	ms	100	60000	Power re-input
0x2410	RTC Time Set	0	UDINT	RW		0	4294967295	Always
0x2411	RTC Data Set	1507585	UDINT	RW		0	4294967295	Always

### ■ Enhanced Control (0x2500~)

Parameter Numbers	Parameter Names	Initial Values	Variable Types	Accessibility	Units	Minimum Values	Maximum Values	Notes
0x2500	Adaptive Filter Function Select	0	UINT	RW	-	0	5	Always
0x2501	Notch Filter 1 Frequency	5000	UINT	RW	Hz	50	5000	Always
0x2502	Notch Filter 1 Width	1	UINT	RW		1	100	Always
0x2503	Notch Filter 1 Depth	1	UINT	RW	-	1	5	Always
0x2504	Notch Filter 2 Frequency	5000	UINT	RW	Hz	50	5000	Always
0x2505	Notch Filter 2 Width	1	UINT	RW		1	100	Always
0x2506	Notch Filter 2 Depth	1	UINT	RW	-	1	5	Always
0x2507	Notch Filter 3 Frequency	5000	UINT	RW	Hz	50	5000	Always
0x2508	Notch Filter 3 Width	1	UINT	RW		1	100	Always
0x2509	Notch Filter 3 Depth	1	UINT	RW	-	1	5	Always
0x250A	Notch Filter 4 Frequency	5000	UINT	RW	Hz	50	5000	Always
0x250B	Notch Filter 4 Width	1	UINT	RW		1	100	Always

0x250C	Notch Filter 4 Depth	1	UINT	RW	-	1	5	Always
0x250D	On-line Gain Tuning Mode	0	UINT	RW	-	0	1	Always
0x250E	System Rigidity for Gain Tuning	5	UINT	RW	-	1	20	Always
0x250F	On-line Gain Tuning Adaptation Speed	1	UINT	RW	-	1	5	Always
0x2510	Off-line Gain Tuning Direction	0	UINT	RW	-	0	1	Always
0x2511	Off-line Gain Tuning Distance	5	UINT	RW	-	1	10	Always
0x2512	Disturbance Observer Gain	0	UINT	RW	%	0	100	Always
0x2513	Disturbance Observer Filter Time Constant	10	UINT	RW	0.1ms	0	1000	Always
0x2514	Current Controller Gain	100	UINT	RW	%	1	150	Always
0x2515	Vibration Suppression Filter Configuration	0	UINT	RW	-	0	5	Always
0x2516	Vibration Suppression Filter 1 Frequency	0	UINT	RW	0.1Hz	0	2000	Always
0x2517	Vibration Suppression Filter 1 Damping	0	UINT	RW	-	0	5	Always
0x2518	Vibration Suppression Filter 2 Frequency	0	UINT	RW	0.1Hz	0	2000	Always
0x2519	Vibration Suppression Filter 2 Damping	0	UINT	RW	-	0	5	Always

#### ■ Monitoring (0x2600~)

Parameter Numbers	Parameter Names	Initial Values	Variable Types	Accessibility	Units	Minimum Values	Maximum Values	Notes
0x2600	Feedback Velocity	-	INT	RO	rpm	-	-	-
0x2601	Command Speed	-	INT	RO	rpm	-	-	-
0x2602	Following Error	-	DINT	RO	pulse	-	-	-
0x2603	Accumulated Operation Overload	-	INT	RO	0.10%	-	-	-
0x2604	Instantaneous Maximum Operation Overload	-	INT	RO	0.10%	-	-	-
0x2605	DC-Link Voltage	-	UINT	RO	Volt	-	-	-
0x2606	Accumulated Regeneration Overload	-	INT	RO	0.10%	-	-	-
0x2607	Single-turn Data	-	UDINT	RO	pulse	-	-	-
0x2608	Mechanical Angle	-	UINT	RO	0.1deg	-	-	-
0x2609	Electrical Angle	-	INT	RO	0.1deg	-	-	-
0x260A	MultiTurn data	-	DINT	RO	rev	-	-	-
0x260B	Drive Temperature 1	-	INT	RO	°C	-	-	-
0x260C	Drive Temperature 2	-	INT	RO	°C	-	-	-
0x260D	Encoder Temperature	-	INT	RO	°C	-	-	-
0x260E	Motor Rated Speed	-	UINT	RO	rpm	-	-	-
0x260F	Motor Maximum Speed	-	UINT	RO	rpm	-	-	-
0x2610	Drive Rated Current	-	UINT	RO	0.1A	-	-	-
0x2611	Hardware Version	-	STRING	RO	-	-	-	-
0x2612	Hall Signal Display	-	UINT	RO	-	-	-	-

0x2613	Bootloader Version	-	STRING	RO	-	-	-	-
0x2614	Warning Code	-	UINT	RO	-	-	-	-
0x2615	Analog Input 1 Value	-	INT	RO	mV	-	-	-
0x2616	Analog Input 2 Value	-	INT	RO	mV	-	-	-
0x2619	RMS Operation Overload	-	INT	RO	0.1%	-	-	-
0x261A	Reserved							-
0x261B	Reserved							-
0x261C	Reserved							-
0x261D	Software Version		STRING	RO				-
0x261E	Pulse Input Frequency		INT	RO	Kpps	-32768	32767	-
0x261F	Torque Limit Value		INT	RO	0.1%	-32768	32767	-
0x2620	Digital Input Status		UINT	RO		0	65535	-
0x2621	Digital Output Status		UINT	RO		0	65535	-
0x2622	Current RTC Time		UDINT	RO		0	4294967295	-
0x2623	Current RTC Data		UDINT	RO		0	4294967295	-
0x2624	Position Demand Internal Value		DINT	RO	pulse	--2147483648	2147483647	-
0x2625	Position Actual Internal Value		DINT	RO		--2147483648	2147483647	-
0x2626	Cumulative Hours of Use		UDINT	RO		0	4294967295	-
0x2627	Number of Inrush Current Switching		DINT	RO		0	4294967295	-
0x2628	Number of Dynamic Brake Switching		DINT	RO		0	4294967295	-
0x2629	Position Demand Value		DINT	RO	UU	--2147483648	2147483647	-
0x262A	Position Actual Value		DINT	RO	UU	--2147483648	2147483647	-
0x262B	Following Error Actual Value		DINT	RO	UU	--2147483648	2147483647	-
0x262C	Torque Demand Value		INT	RO	0.1%	-32768	32767	-
0x262D	Torque Actual Value		INT	RO	0.1%	-32768	32767	-

### ■ Third Party Motor Support (0x2800~)

Parameter Numbers	Parameter Names	Initial Values	Variable Types	Accessibility	Units	Minimum Values	Maximum Values	Variable Attribute
0x2800	[Third Party Motor] Type	0	UINT	RW	-	0	1	Power re-input
0x2801	[Third Party Motor] Number of Poles	8	UINT	RW	-	2	1000	Power re-input
0x2802	[Third Party Motor] Rated Current	2.89	FP32	RW	Arms	-	-	Power re-input
0x2803	[Third Party Motor] Maximum Current	8.67	FP32	RW	-	-	-	Power re-input
0x2804	[Third Party Motor] Rated Speed	3000	UINT	RW	rpm	1	60000	Power re-input
0x2805	[Third Party Motor] Maximum Speed	5000	UINT	RW	rpm	1	60000	Power re-input
0x2806	[Third Party Motor] Inertia	0.321	FP32	RW	Kg.m <sup>2</sup> .10 <sup>-4</sup>	-	-	Power re-input

0x2807	[Third Party Motor] Torque Constant	0.46	FP32	RW	Nm/A	-	-	Power re-input
0x2808	[Third Party Motor] Phase Resistance	0.82	FP32	RW	ohm	-	-	Power re-input
0x2809	[Third Party Motor] Phase Inductance	3.66	FP32	RW	mH	-	-	Power re-input
0x280A	[Third Party Motor] TN Curve Data 1	3000	UINT	RW	rpm	1	60000	Power re-input
0x280B	[Third Party Motor] TN Curve Data 2	100	FP32	RW	%	-	-	Power re-input
0x280C	[Third Party Motor] Hall Offset	0	UINT	RW	deg	0	360	Power re-input

### ■ Index Objects (0x3000~)

Parameter Numbers	Parameter Names	Initial Values	Variable Types	Accessibility	Units	Minimum Values	Maximum Values	Notes
0x3000	Control Mode	1	UINT	RW	-	0	9	Always
0x3001	Coordinate Select	0	UINT	RW	-	0	1	Always
0x3002	Baud Rate Select	3	UINT	RW	-	0	3	Always
0x3003	Pulse Input Logic Select	0	UINT	RW	-	0	5	Always
0x3004	Pulse Input Filter Select	0	UINT	RW	-	0	4	Always
0x3005	PCLEAR Mode Select	0	UINT	RW	-	0	2	Always
0x3006	Encoder Output Pulse	10000	UDINT	RW	pulse	0	2147483647	Always
0x3007	Encoder Output Mode	0	UINT	RW	-	0	1	Always
0x3008	Start Index Number (0~63)	0	UINT	RW	-	0	64	Always
0x3009	Index Buffer Mode	1	UINT	RW	-	0	1	Always
0x300A	I/O Signal Configuration	0	UINT	RW	-	0	65535	Always
0x300B	REGT Configuration	0	UINT	RW	-	0	5	Always
0x300C	Electric Gear Numerator 1	1	UDINT	RW	-	1	2147483647	Always
0x300D	Electric Gear Numerator 2	1	UDINT	RW	-	1	2147483647	Always
0x300E	Electric Gear Numerator 3	1	UDINT	RW	-	1	2147483647	Always
0x300F	Electric Gear Numerator 4	1	UDINT	RW	-	1	2147483647	Always
0x3010	Electric Gear Denominator 1	1	UDINT	RW	-	1	2147483647	Always
0x3011	Electric Gear Denominator 1	1	UDINT	RW	-	1	2147483647	Always
0x3012	Electric Gear Denominator 1	1	UDINT	RW	-	1	2147483647	Always
0x3013	Electric Gear Denominator 1	1	UDINT	RW	-	1	2147483647	Always
0x3014	Electric Gear Mode	0	UINT	RW	-	0	1	Always
0x3015	Electric Gear Offset	0	INT	RW	-	-32768	32767	Always
0x3016	Position Limit Function	0	UINT	RW	-	0	1	Always

0x3017	Backlash Compensation	0	UINT	RW	-	0	1000	Always
0x3018	Homing Method	34	SINT	RW	-	-128	127	Always
0x3019	Home Offset	0	DINT	RW		-2147483648	2147483647	Always
0x301A	Homing Speed during Search for Switch	500000	UDINT	RW		0	1073741824	Always
0x301B	Homing Speed during Search for Zero	100000	UDINT	RW	-	0	1073741824	Always
0x301C	Homing Acceleration	200000	UDINT	RW	-	0	1073741824	Always
0x301D	Following Error Window	600000	UDINT	RW	-	0	1073741823	Always
0x301E	Following Error Timeout	0	UINT	RW	-	0	65535	Always
0x301F	Velocity Window Time	0	UINT	RW	-	0	65535	Always
0x3020	Software Position Min Limit	-1000000000	DINT	RW	-	-1073741824	1073741823	Always
0x3021	Software Position Max Limit	1000000000	DINT	RW	-	-1073741824	1073741823	Always
0x3022	Positive Torque Limit	3000	UINT	RW	-	0	5000	Always
0x3023	Negative Torque Limit	3000	UINT	RW	-	0	5000	Always
0x3024	Quick Stop Deceleration	200000	UDINT	RW		0	2147483647	Always

---

---

## Revision History

---

---

Number	Date Issued	Revised Content	Version Number	Notes
1	2018.07.19	New distribution	1.0	
2	2020.05.30	Changed company name to 'LS ELECTRIC'	1.1	
3	2020.10.05	Function description modification, caution addition, miswriting correction	1.3	
4	2024.02.29	Adding function and description, correct misspelled, correct misspelled of encoder product feature contents	1.4	
5				
6				
7				

# Product Warranty

---

---

L7C Series was produced using the strict quality control guidelines and testing procedures developed by technicians of our company.

The warranty applies for 12 months after the date of installation. If the installation date is not specified, the warranty is valid for 18 months after the date of manufacture. However, the terms of this warranty may change depending on the terms of the contract. Be aware during purchase that the products in this manual are subject to discontinuation or modifications without notice.

## Free Technical Support

If the drive malfunctions under proper usage conditions and the product warranty is still valid, contact one of our agencies or the designated service center. We will repair the product free of charge.

## Paid Technical Support

We provide product repair at a cost in the following cases.

- The malfunction is a result of negligence on the part of the consumer.
- The malfunction is a result of inappropriate voltage or defects in the machines connected to the product.
- The malfunction is a result of an act of God (fire, flood, gas, earthquake, etc.)
- The product was modified or repaired by someone other than our agency or service center worker.
- The name tag of our company is not attached on the product.
- The warranty has expired.

※ After installing the servo, fill out this quality assurance form and send it to our quality assurance department(technical support).





[www.ls-electric.com](http://www.ls-electric.com)

## LS ELECTRIC Co., Ltd.

### ■ Headquarter

LS-ro 127(Hogye-dong) Dongan-gu, Anyang-si, Gyeonggi-Do, 14119, Korea

### ■ Seoul Office

LS Yongsan Tower, 92, Hangang-daero, Yongsan-gu, Seoul, 04386, Korea

Tel: 82-2-2034-4033, 4888, 4703 Fax: 82-2-2034-4588

E-mail: [automation@lselectric.co.kr](mailto:automation@lselectric.co.kr)

### ■ Factory

56, Samseong 4-gil, Mokcheon-eup, Dongnam-gu, Cheonan-si, Chungcheongnam-do, 31226, Korea

### ■ Overseas Subsidiaries

#### • LS ELECTRIC Japan Co., Ltd. (Tokyo, Japan)

Tel: 81-3-6268-8241 E-Mail: [jschuna@lselectric.biz](mailto:jschuna@lselectric.biz)

#### • LS ELECTRIC (Dalian) Co., Ltd. (Dalian, China)

Tel: 86-411-8730-6495 E-Mail: [jiheo@lselectric.com.cn](mailto:jiheo@lselectric.com.cn)

#### • LS ELECTRIC (Wuxi) Co., Ltd. (Wuxi, China)

Tel: 86-510-6851-6666 E-Mail: [sblee@lselectric.co.kr](mailto:sblee@lselectric.co.kr)

#### • LS ELECTRIC Shanghai Office (China)

Tel: 86-21-5237-9977 E-Mail: [tsjun@lselectric.com.cn](mailto:tsjun@lselectric.com.cn)

#### • LS ELECTRIC Vietnam Co., Ltd.

Tel: 84-93-631-4099 E-Mail: [jhchoi4@lselectric.biz](mailto:jhchoi4@lselectric.biz) (Hanoi)

Tel: 84-28-3823-7890 E-Mail: [sjbaik@lselectric.biz](mailto:sjbaik@lselectric.biz) (Hochiminh)

#### • LS ELECTRIC Middle East FZE (Dubai, U.A.E.)

Tel: 971-4-886-5360 E-Mail: [salesme@lselectric.biz](mailto:salesme@lselectric.biz)

#### • LS ELECTRIC Europe B.V. (Hoofddorf, Netherlands)

Tel: 31-20-654-1424 E-Mail: [europartner@lselectric.biz](mailto:europartner@lselectric.biz)

#### • LS ELECTRIC America Inc. (Chicago, USA)

Tel: 1-800-891-2941 E-Mail: [sales.us@lselectricamerica.com](mailto:sales.us@lselectricamerica.com)



Specifications in this instruction manual are subject to change without notice due to continuous products development and improvement.